



Bentone ST 97-146

Reservdelar och tillbehör

Spare Parts and Accessories

Ersatzteile und Zubehör

Pièces détachées et accessoires



MADE IN SWEDEN

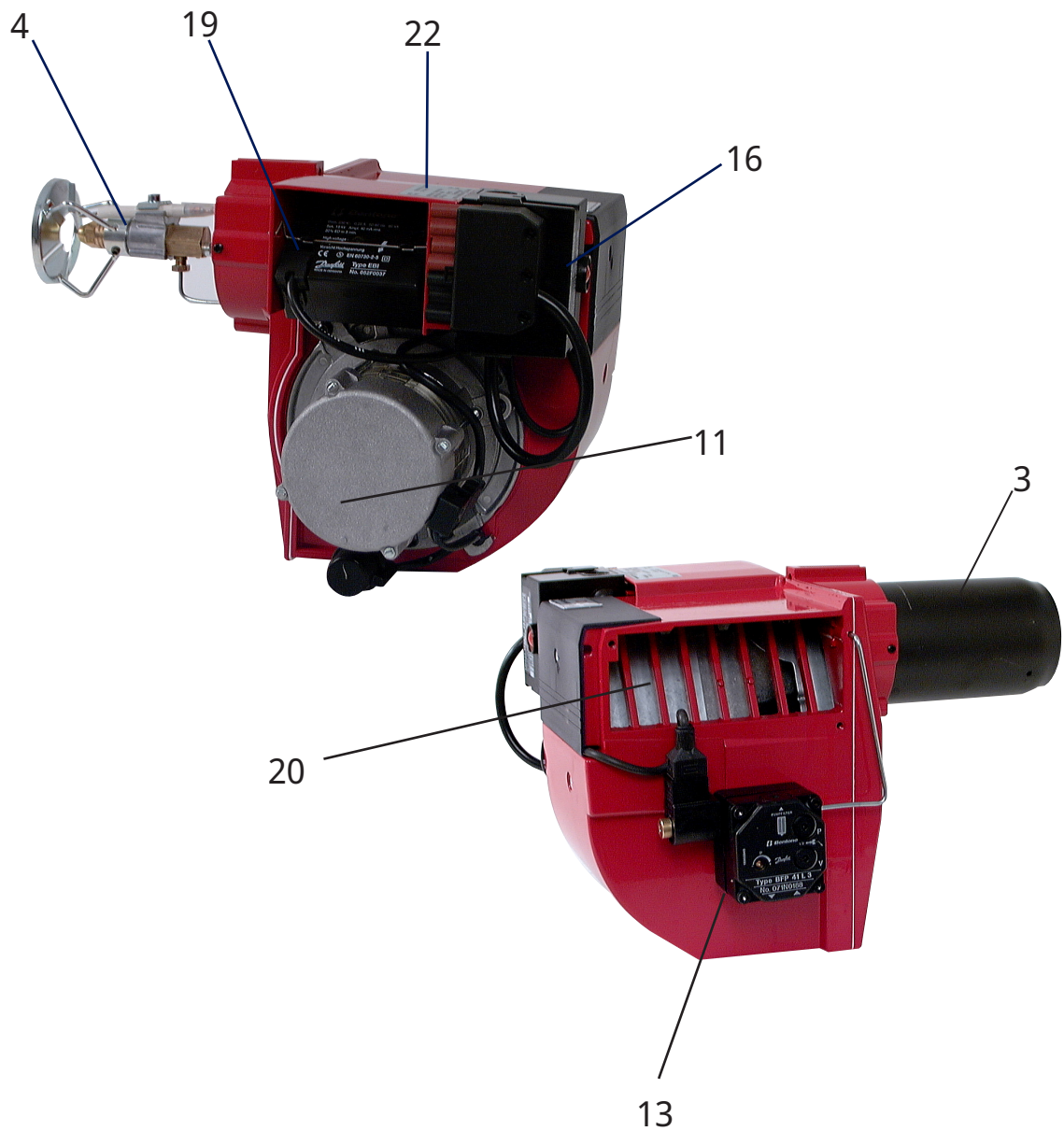









Brännarrör • Flame tube • Brennerrohr • Tube de brûleur _____	3
Insats • Nozzle Assembly • Düsenstock • Ligne Porte-Gicleur _	4
Anslutningsfläns • Fixing flange • Anschlussflansch • Bridge de fixation	9
Motor • Motor • Motor • Moteur • ST 97 - ST 120 _____	11
Motor • Motor • Motor • Moteur • ST 133, ST 146 _____	12
Pump • Pump • Pumpe • Pompe _____	13
Eldningsautomat • Oil burner control • Feuerungsautomat • Contrôle du brûleur	16
Transformator • Transformer • Transformator • Transformateur	19
Luftreglering • Air regulation • Luftregelung • Régularisation à air	20
Fläkthus • Fan housing • Brennergehäuse • Carter du rotor	22
Övrigt • Sundries • Verschiedenes • Divers _____	23

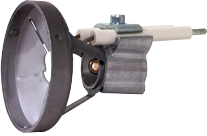









	Brännarrör PL	Flame tube	Brennerrohr	Tube de brûleur	
	ST 97 - ST 120				
	80 mm				
	10-4-24-10				11780201
	10-5-16-8				11780305
	10-8-10-6-19-10				11780401
	127 mm				
	10-8-10-6-19-10				11780402
	Brännarrör PL	Flame tube	Brennerrohr	Tube de brûleur	
	ST 97 - ST 120				
	80 mm				
	6-7-21,5-10				11780103
	6-7-19-10				11780105
	127 mm				
	6-7-19-10				11780106
	157 mm				
	6-7-19-8				11780111
6-7-16-8				11780109	
	Brännarrör K, KA, KS	Flame tube	Brennerrohr	Tube de brûleur	
	ST 120 - ST 146				
	94 mm				11728401
	147 mm				11728402
	224 mm				11728403
	Brännarrör E	Flame tube	Brennerrohr	Tube de brûleur	
	ST 97 - ST 120				
	87 mm				11934003
	124 mm				11934005
	Brännarrör FU	Flame tube	Brennerrohr	Tube de brûleur	
	ST 97 - ST 120				
	103 mm				11764301
	133 mm				11764304
	Brännarrör F, FV	Flame tube	Brennerrohr	Tube de brûleur	
	ST 97 - ST 120				
	127 mm				11591401
	Brännarrör C	Flame tube	Brennerrohr	Tube de brûleur	
	94 mm				11738514
	138 mm				11952505
	Brännarrör R2	Flame tube	Brennerrohr	Tube de brûleur	11951905
	Ø 69 131 mm				
	Brännarrör E värmebeständigt	Flame tube heat resistant	Brennerrohr hitzbeständig	Tube de brûleur résistant à la chaleur	
	ST 97 - ST 120				
	87 mm				11934004
	Brännarrör ST 146/2	Flame tube	Brennerrohr	Tube de brûleur	
	263 mm				1192310305
	163 mm				1192310205







	Insats	Nozzle assembly	Düsenstock	Ligne porte-gicleur	
	ST 97				11894301
	FUV 103 mm				
	ST 108				
	FV 127mm				11894301
	FUV 133 mm				11894302
	Insats ST 133 - 146	Nozzle assembly	Düsenstock	Ligne porte-gicleur	
	K				
	94 mm				11906001
	147 mm				11906002
	KA				
	147 mm				11906005
	224 mm				11906009
	Insats ST 133 - 146	Nozzle assembly	Düsenstock	Ligne porte-gicleur	
	KAV				
	94 mm				11906104
	224 mm				11906106
	ST 120				
	KAV 147 mm				11907505
	Insats ST 146	Nozzle assembly	Düsenstock	Ligne porte-gicleur	11906011
	KS				
	147 mm				
	Insats ST 133 - 146	Nozzle assembly	Düsenstock	Ligne porte-gicleur	11906111
	KSV				
	147 mm				
	Insats ST 120	Nozzle assembly	Düsenstock	Ligne porte-gicleur	12128202
	RV 16				
	131 mm				
	Insats ST 120	Nozzle assembly	Düsenstock	Ligne porte-gicleur	12128201
	R 16				
	131 mm				
	Insats ST 120	Nozzle assembly	Düsenstock	Ligne porte-gicleur	
	KA, C				
	94 mm				11894501
	147 mm				11894502
	Insats ST 120	Nozzle assembly	Düsenstock	Ligne porte-gicleur	
	E, EM				
	87 mm				11861601
	E				
	124 mm				11861602
	215 mm				11861604
	PL				
80 mm				11861601	
	127 mm				11861602

	Insats ST 97- 108	Nozzle assembly	Düsenstock	Ligne porte-gicleur	
	PLV 127 mm				11894402
	Insats ST 120	Nozzle assembly	Düsenstock	Ligne porte-gicleur	
	Förvärmare 127 mm	Preheater	Vorwärmer	Péchauffeur	11894602
	Insats ST 146/2	Nozzle assembly	Düsenstock	Ligne porte-gicleur	
	För brännarrör	For flame tube	Für Brennerrohr	Pour tube de brûleur	
	163 mm				11906006
	263 mm				11906007
	Oljerör ST 97 - 120 För brännarrör	Nozzle pipe	Düsenrohr	Canne porte-gicleur	
		For flame tube	Für Brennerrohr	Pour tube de brûleur	
	E, EM 87 mm				12071314
	E 124 mm				12071302
	212 mm				12071304
	R 131 mm				12071305
	Oljerör ST 108	Nozzle pipe	Düsenrohr	Canne porte-gicleur	12071302
	För brännarrör	For flame tube	Für Brennerrohr	Pour tube de brûleur	
	FU 103 mm				
	Oljerör	Nozzle pipe	Düsenrohr	Canne porte-gicleur	
	För brännarrör	For flame tube	Für Brennerrohr	Pour tube de brûleur	
	ST 97 - 108 FUV 103 mm				12071401
	ST 108 FUV 133 mm				12071407
	Oljerör	Nozzle pipe	Düsenrohr	Canne porte-gicleur	
	För brännarrör	For flame tube	Für Brennerrohr	Pour tube de brûleur	
	K, KA, C ST 97 - 120 94 mm				12071307
	ST 133 - 146 94 mm				12071305
	147 mm				12071306
	224 mm				12071309
	Oljerör	Nozzle pipe	Düsenrohr	Canne porte-gicleur	
	För brännarrör	For flame tube	Für Brennerrohr	Pour tube de brûleur	
	KAV, RV ST 97 - 120 147 mm				12071408
	ST 133 - 146 94 mm				12071405
	224 mm				12071403

	Oljerör För brännarrör PL ST 97 - 108 80 mm 127 mm	Nozzle pipe For flame tube	Düsenrohr Für Brennerrohr	Canne porte-gicleur Pour tube de brûleur	12071314 12071302
	Oljerör För brännarrör PLV ST 97 - 108 127 mm ST 120 127 mm	Nozzle pipe For flame tube	Düsenrohr Für Brennerrohr	Canne porte-gicleur Pour tube de brûleur	12071401 12071403
	Oljerör För brännarrör B 146/2 163 mm 263 mm	Nozzle pipe For flame tube	Düsenrohr Für Brennerrohr	Canne porte-gicleur Pour tube de brûleur	12071306 12071308
	Fövärmare FPHE5 30-110W 70°	Preheater	Vorwärmer	Réchauffeur	12086705
	Fövärmare FPHE10 30-190W 70°	Preheater	Vorwärmer	Réchauffeur	12086707
	Kabel, fövärmare 400 mm	Cable, preheater	Kabel, Vorwärmer	Cable, réchauffeur	11477706
	Elektrodhållare	Elektrode holder	Elektrodenhalter	Porte-électrode	11598401
	Tändeledrod ST 97 - 145	Ignition electrode	Zündeledrod	Electrode 'aiiumage	11593701
	Par	Pair of	Paar	1 Paire	91593701
	Tändeledrod ST 146/2	Ignition electrode	Zündeledrod	Electrode 'aiiumage	11924301
	Par	Pair of	Paar	1 Paire	91924301
	Dubbeledrod ST 97 - 120	Double electrode	Doppeledrod	Electrode double	11886701
	Tändeledrodsats	Ignition electrode set	Zündeledrod satz	Electrode 'aiiumage ensemble	12111901



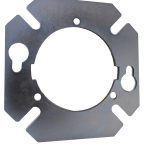





	Bromsskivaesats ST 97 - 120 FU, FUV	Brake plate	Stauscheibe	Disque accroche- flamme	11591501
	Skruv, elektrodhållare	Screw, elektrode holder	Elektrodenhalter	Porte-électrode	12022901
	Bromsskiva ST 146/2	Brake plate	Stauscheibe	Disque accroche- flamme	11887102
	Bromsskiva ST 97 - 120 FUV	Brake plate	Stauscheibe	Disque accroche- flamme	11591202
	Bromsskiva ST 120 - 146 KA, KAV	Brake plate	Stauscheibe	Disque accroche- flamme	11885801
	Bromsskiva ST 133 - 146 K, KV	Brake plate	Stauscheibe	Disque accroche- flamme	11731701
	Bromsskiva ST 133 - 146 KS 24	Brake plate	Stauscheibe	Disque accroche- flamme	12026001
	Bromsskiva S diam 24	Brake plate	Stauscheibe	Disque accroche- flamme	11984203
	Bromsskiva R1	Brake plate	Stauscheibe	Disque accroche- flamme	91975601

	Skala, insatsreglering ST 97 - 146	Scale, nozzle assembly adjustment	Skala, Düsenstock- einstellung	Echelle, ligne porte-gicleur	12071001
	Skala, insatsreglering ST 146/2	Scale, nozzle assembly adjustment	Skala, Düsenstock- einstellung	Echelle, ligne porte-gicleur	12071002
	Täckplåt, insatsreglering ST 97 - 146	Cover plate, nozzle assembly adjustment	Deckplatte, Düsenstock-einstellung	Plaque de recouvrement, ligne porte-gicleur	12071001
	Täckplåt, insatsreglering ST 97 - 133	Cover plate, nozzle assembly adjustment	Deckplatte, Düsenstock-einstellung	Plaque de recouvrement, ligne porte-gicleur	12056601
	Täckplåt, insatsreglering ST 146/2	Cover plate, nozzle assembly adjustment	Deckplatte, Düsenstock- einstellung	Plaque de recouvrement, ligne porte-gicleur	12051402
	Ställskruv, insats	Adjustment screw, nozzle assembly	Stellschraube, Düsenstock	Vis de réglage, ligne porte-gicleur	12070801
	Distansrör	Spacing tube	Abstandsrohr	Tube d' écartement	11741601
	Bussning	Bushing	Buchse	Douille	11847901
	O-ring, förvärmare	O-ring, preheater	O-ring, Vorwärmer	Joint torique, réchauffeur	11316802
	Låsring, förvärmare	Locking ring, preheater	Sicherungsring, Vorwärmer	Circlip, réchauffeur	11801802
	Tändkabelpar Vinklad L=300mm	Set of ignition	Zündkabelpar	Câble H.T. 1 paire	12068730

	Anslutningsfläns	Fixing flange	Anschlussflansch	Bride de fixation	11883001
	Anslutningsfläns	Fixing flange	Anschlussflansch	Bride de fixation	11811601
	Anslutningsfläns	Fixing flange	Anschlussflansch	Bride de fixation	11854501
	Anslutningsfläns ST 97 - 120	Fixing flange	Anschlussflansch	Bride de fixation	0439030834
	Anslutningsfläns ST 97 - 120	Fixing flange	Anschlussflansch	Bride de fixation	11852501
	Anslutningsfläns ST 133 - 146	Fixing flange	Anschlussflansch	Bride de fixation	11904001

	Packning	Gasket	Dichtung	Joint	11854201
	Packning	Gasket	Dichtung	Joint	11819101
	Packning	Gasket	Dichtung	Joint	11854301
	Packning	Gasket	Dichtung	Joint	11883101
	Packning ST 97 - 120	Gasket	Dichtung	Joint	0439012027
	Packning ST 97 - 120	Gasket	Dichtung	Joint	11875603
	Packning ST 133 - 146	Gasket	Dichtung	Joint	11739801
	Packning ST 146/2	Gasket	Dichtung	Joint	11903801

	Motor 90W	Motor	Motor	Moteur	
	3µF				92090501
	4µF				92090401
	Fläkt hjul	Fan wheel	Gebälserad	Rotor	
	ST 97				
	97 x 42 x 8				11417603
	ST 108				
	108 x 42 x 8				11417604
	ST 120				
	120 x 42 x 8				11417601
	Drivkoppling	Drive coupling	Antriebskupplung	Accouplement d'entraînement	11407210
	O-ring	O-ring	O-Ring	Joint torique	11316851
	121,0 x 1,6				
	Kondensator	Capacitor	Kondensator	Condensateur	
	3µF				12093301
	4µF				12093001
	Kabel	Cable	Kabel	Câble	12086602
	L 360 mm.				

	Motor 125W	Motor	Motor	Moteur	92090001
	Fläkthjul ST 133 133x52x8 ST 146 146x52x8	Fan wheel	Gebläserad	Rotor	11867101 11872601
	Drivkoppling	Drive coupling	Antriebskupplung	Accouplement d'entraînement	11127823
	O-ring 121,0 x 1,6	O-ring	O-Ring	Joint torique	11316841
	Kondensator 3µF	Capacitor	Kondensator	Condensateur	12093301
	Kabel, motor L 360 mm.	Cable, motor	Kabel, Motor	Câble, moteur	12086602
	Packning	Gasket	Dichtung	Joint	11874201
	Fläns	Flange	Flansch	Bride	11700902

	Pump med kabel BFP11L3	Pump with cable	Pumpe mit Kabel	Pompe avec câble	92074002
	Pump med kabel BFP41L3	Pump with cable	Pumpe mit Kabel	Pompe avec câble	92074001
	Magnetventil BFP	Solenoid valve	Magnetventil	Electrovanne	11597303
	Innerdel	Inner part	Innenteil	Partie interieure	11774201
	Spole BFP	Coil	Spule	Bobine	11597404
	Kabel BFP	Cable	Kabel	Câble	11597505
	400 mm				
	Filter BFP41L3	Filter	Filter	Filtre	11774901
	Packing, lock BFP	Gasket, cover	Dichtung, Deckel	Joint, couvercle	11981001
	Plugg, med o-ring BFP	Plug and o-ring	Stöpsel und O-ring	Cheville, Joint torique	11786101
	Plugg Suntec	Plug	Stöpsel	Cheville	11461201
	Bricka Suntec	Washer	Scheibe	Plateau	11461202



Pump, AS47C-6P ST 97 - 146	Pump	Pumpe	Pompe	12026432
-------------------------------	------	-------	-------	----------

2-rörs Styckförpackning	2-pipe Single-piece package	2-Rohr Stückverpackung	2 tuyaux Emballage par pièces	82026432
----------------------------	-----------------------------------	---------------------------	-------------------------------------	----------

Med kabel	With cable	Mit Kabel	Avec câble	92026432
-----------	------------	-----------	------------	----------

Pump, AS47C-6M ST 97 - 120	Pump	Pumpe	Pompe	12026431
-------------------------------	------	-------	-------	----------

1-rörs Styckförpackning	1-pipe Single-piece package	1-Rohr Stückverpackung	1 tuyau Emballage par pièces	82026431
----------------------------	--------------------------------	---------------------------	------------------------------------	----------

Med kabel	With cable	Mit Kabel	avec câble	92026431
-----------	------------	-----------	------------	----------



Spole AS47C	Coil	Spule	Bobine	91597101
----------------	------	-------	--------	----------



Magnetventil AS47C	Solenoid valve	Magnetventil	Electrovanne	91597201
-----------------------	----------------	--------------	--------------	----------



Kabel AS47C 500 mm	Cable	Kabel	Câble	11597509
--------------------------	-------	-------	-------	----------









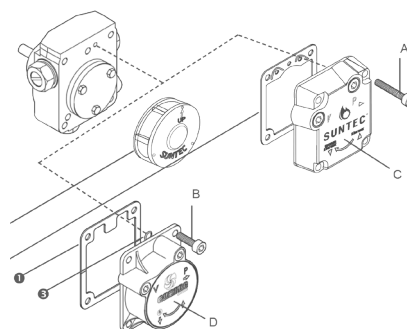
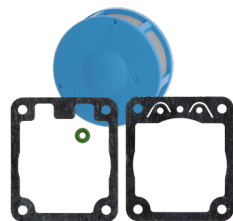

Magnetventil, 1/8" SL1, Suntec	Solenoid valve	Magnetventil	Electrovanne	12119401
-----------------------------------	----------------	--------------	--------------	----------



Kabel Danfoss 900 mm	Cable	Kabel	Câble	11597506
----------------------------	-------	-------	-------	----------



Filtersats, filter, packningar, o-ring Suntec, AN,AS,AP,AT,AL-67	Filter kit, filter, gaskets, o-ring	Filter Kit, Filter, Dichtungs, O-Ring	Kit de filtre, filtre, joint, joint torique	11457002
---	--	--	--	----------



	Förbindelserör ST 97 - 108 FU 103 mm PL, 80 mm RV 131 mm PL 127, 157 mm	Connecting pipe	Öldruckrohr	Trompette	11863801 11884501
	Förbindelserör ST 120 K, KA, R 147 mm	Connecting pipe	Öldruckrohr	Trompette	11881902
	Förbindelserör ST 120 K 94 mm	Connecting pipe	Öldruckrohr	Trompette	11855101
	Förbindelserör K, KA, C 94 mm 147 mm ST 133/ST 146/2	Connecting pipe	Öldruckrohr	Trompette	11874801 11874802 11874804
	Förbindelserör KAV 147 mm ST133, ST146	Connecting pipe	Öldruckrohr	Trompette	11907802
	Förbindelserör FUV, PLV 127 mm	Connecting pipe	Öldruckrohr	Trompette	11869502
	Nippel, manometer	Nipple, pressure gauge	Nippel, Manometer	Raccord, manomètre	11860701

	Reläbox TF 832.3	Control box	Steuergerät	Boite de contrôle	11781007
	Styckförpackning				91781007
	Reläbox TF 834E.3	Control box	Steuergerät	Boite de contrôle	11702704
	ST 97 - 120				
	Styckförpackning				91702704
	Reläsockel TF	Relay base	Relaissockel	Socle de raccordement	91991001
	Fläns TF, fotomotstånd	Flange, photoresistor	Flansch, Fotowiderstand	Bride, cellule photorésistante	39011302
	ST 97 - 120				
	Fläns TF, fotomotstånd	Flange, photoresistor	Flansch, Fotowiderstand	Bride, cellule photorésistante	39011303
	ST 133 - 146				
	Fotomotstånd TF MZ770S	Photoresistor	Fotowiderstand	Cellule photorésistante	
	Långt utförande	Long design	Lange Ausföhrung	Modèle longue	11800301
	Kort utförande	Short design	Kurze Ausföhrung	Modèle courte	11800303

	Reläbox LOA24	Control box	Steuergerät	Boite de contrôle	11559504
	Styckförpackning	Single-piece package	Stückverpackung	Emballage par pièces	91559504
	Reläbox LMO14.113C2E	Control box	Steuergerät	Boite de contrôle	
	Industriförpackning	Industrial package	Industrie-verpackung	Emballage industriel	12000102
	styckförpackning	single-piece package	stückverpackung	emballage par pièces	92000102
	Reläbox LMO24.255C2E	Control box	Steuergerät	Boite de contrôle	12024202
	Reläsockel	Relay base	Relaissockel	Socle de raccordement	91559600
	Fläns, fotomotstånd	Flange, photoresistor	Flansch, Fotowiderstand	Bride, cellule photorésistante	11776801
	Fotomotstånd QRB1B	Photoresistor	Fotowiderstand	Cellule photorésistante,	
	t.o.m serienummer	up to serial number	bis zur Seriennummer	jusqu'au numéro de série	
	ST 108- 2499794				
	ST 120- 2501093				
	ST 133- 2499824				
	ST 146- 2499866				
Kort utförande	Short design	Kurze Ausföhrung	Modèle courte	91240905	
Långt utförande	Long design	Lange Ausföhrung	Modèle longue	91240907	

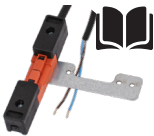
	Fotomotstånd till brännare med LOA	Photoresistor for burners with LOA	Fotowiderstand für Brenner mit LOA	Cellule photorésistante pour les brûleurs avec LOA	12070701
	QRB1 305mm				
	från serienummer	from serial number	von der Seriennummer	à partir du numéro de série	
	ST 108- 2499795				
	ST 120- 2501094				
	ST 133- 2499825				
	ST 146- 2499867				
	Flamdetektor till brännare med LMO/ LMV	Flame detector for burners with LMO/ LMV	Flammdetektor für Brenner mit LMO/ LMV	Décteur de flamme pour les brûleurs avec LMO/LMV	12119641
	QRB4B-B025B40B				
	L=250				
	från serienummer	from serial number	von der Seriennummer	à partir du numéro de série	
	ST 108- 2499795				
	ST 120- 2501094				
	ST 133- 2499825				
	ST 146- 2499867				
	Packning, fotomotstånd	Gasket, photoresistor	Dichtung, Fotowiderstand	Joint, cellule photorésistante	11856001
	Anslutning, Extern Reset	Connection, Extern Reset	Anschluss, Extern Reset	Connection de Extern Reset	92062401

	Kontaktidon, hondel 7-pol med kåpa och kabel 370 mm	Plug-in contact, female 7-pole with cover and cable	Buchsenteil 7-polig mit Kasten und Kabel	Prise "européenne", femelle 7-polaire avec Capot et câble	91558608
	Utan kabel	Without cable	ohne Kabel	sans câble	91558501
	Kontaktidon, hondel 7-pol	Plug-in contact, male 7-pole	Steckerteil 7-polig	Prise "européenne", mâle 7-polaire	11558500
	Kabelgenomföring	Cable inlet	Kabeldurchführung	Douille de passage câble	11810001
	Transformator Danfoss EBI	Transformer	Transformator	Transformateur	12064301
	Styckförpackning	Single piece package	Stückverpackung	Emballage par piece	92064301
	Transformator FIDA 50% ED 26/35 2POLE	Transformer	Transformator	Transformateur	12043201
	Kabelgenomföring	Cable inlet	Kabeldurchführung	Douille de Câble H.T.	11990901

	Fästhjäder, transformator	Fixing spring, transformer	Befestigungsfeder, Transformator	Ressort de fixation, transformateur	11855801
	Tändkabelpar	Pair of ignition cable	Zündkabelpaar	Câble H.T. 1 paire	
	L=300				12068730
	L=400				12068740
	Kabel, transformator	Cable, transformer	Kabel, Transformator	Câble, transformateur	
	Danfoss 300 mm				12062005
	Danfoss 500 mm				12062004
	Kabel, transformator	Cable, transformer	Kabel, Transformator	Câble, transformateur	11977103
	Fida 280 mm				
	Anslutningsstos	Connecting piece	Anschluss-Stück	Pièce de raccordement	91859104
	ST 97 - ST 120				
	Anslutningsstos front entry	Connection piece front entry	Anschluss-Stück front entry	Pièce de raccordement. front entry	91859107
	ST 97 - ST 120				
	Anslutningsstos	Connecting piece	Anschluss-Stück	Pièce de raccordement	91859105
	ST 133 - ST 146				
	Ljuddämpare ST 97 - ST 120	Silencer	Schalldämpfer	Silencieux	1187490105
	Med ram för självstängande luftspjäll	With frame for automatic air damper	Mit Rahmen für Luft- ansaugvorrichtung	Avec cadre pour clapet d'air automatique	91883802
	Ljuddämpare ST 133 - ST 146	Silencer	Schalldämpfer	Silencieux	1198490105
	Packning, anslutningsstos	Gasket, connecting piece	Dichtung, Anschluss-Stück	Joint, Pièce de raccordement	11854101
	ST 97 - ST 120				
	Packning, anslutningsstos	Gasket, connecting piece	Dichtung, Anschluss-Stück	Joint, Pièce de raccordement	11905701
	ST 133 - ST 146				

	Luftregleringsplåt ST 97 - ST 120	Air regulation plate	Luftestellplatte	Plaque de réglage d'air	11852201
	Luftregleringsplåt ST 133 - ST 146	Air regulation plate	Luftestellplatte	Plaque de réglage d'air	11867401
	Luftspjäll ST 97 - ST 120	Air damper	Luftklappe	Volet d'air	11851001
	Luftspjäll ST 133 - ST 146	Air damper	Luftklappe	Volet d'air	11867501
	Täckplåt, luftreglering ST 97 - ST 120	Cover plate, air regulation	Deckplatte, Luftestellung	Plaque de recouvrement, réglage d'air	11887001
	Täckplåt, luftreglering ST 133 - ST 146	Cover plate, air regulation	Deckplatte, Luftestellung	Plaque de recouvrement, réglage d'air	11887401
	Bussning	Bushing	Buchse	Douille	11847901
	Skala, luftreglering	Scale air regulation	Skala, Luftestellung	Echelle, réglage d'air	11887801
	Ställskruv, luftreglering	Adjustment screw, air regulation	Stellschraube, Luftestellung	Vis de réglage, réglage d'air	11848501
	Täcklock	Cover plate	Deckplatte	Plaque de recouvrement	11850011
	Skruv	Screw	Schraube	Vis	11750702

	Fläkthusdel, bakre	Fan housing, rear part	Brennergehäuse, hinterer Teil	Carter du rotor, partie arrière	1206300127
	ST 97 - 120 röd	red	rot	rouge	
	Fläkthusdel, främre	Fan housing, front part	Brennergehäuse, vorderer Teil	Carter du rotor, partie frontale	
	ST 120 röd	red	rot	rouge	1184950227
	omålad KA	non-lacquered	nicht lackiert	non-lacqué	11849502 1188840227
	Fläkthusdel, främre	Fan housing, front part	Brennergehäuse, vorderer Teil	Carter du rotor, partie frontale	
	ST 97 - 108 röd	red	rot	rouge	1185690227
	omålad	non-lacquered	nicht lackiert	non-lacqué	11856902
	Fläkthusdel bakre	Fan housing rear part	Brennergehäuse hinterer Teil	Carter du rotor partie arrière	
	ST 133 - 146 röd	red	rot	rouge	1207200127
	omålad	non-lacquered	nicht lackiert	non-lacqué	12072001
	Fläkthusdel främre	Fan housing front part	Brennergehäuse vorderer Teil	Carter du rotor partie frontale	
	ST 133 - 146 röd	red	rot	rouge	1186310227
	omålad	non-lacquered	nicht lackiert	non-lacqué	11863102
	Avskärningsvägg, fläkthus	Shielding arrangement, fan housing	Abschirmung, Brennergehäuse	Ecran de partition, carter du rotor	
	ST 120 ST 97 - 108				11849601 11860801
	Avskärningsvägg, fläkthus	Shielding arrangement, fan housing	Abschirmung, Brennergehäuse	Ecran de partition, carter du rotor	11863201
	ST 133 - 146				

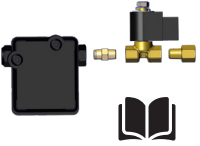
	Oljeslang L=900	Flexible pipe	Ölschlauch	Flexible	12110015
	Nippel G1/4x1/4	Nipple	Nipple	Raccord	12115601
	Nippel G1/4xR3/8	Nipple	Nipple	Raccord	12115702
	Nippel G1/4xR1/4	Nipple	Nipple	Raccord	12115701
	Kopparpackning	Copper gasket	Kupferdichtung	Joint en cuivre	11021210
	Oljeslang vinkel 1/4 L=900	Flexible pipe	Ölschlauch	Flexible	12110014
	Magnetventil kontiuerlig fläkt för pump med ett munstycksuttag	Soloid valve continous fan for pump with one nozzle outlet	Kontunuirliches Gebläse. Montage an Ölpumpe mit einen Düsenausgang	Ventilation continue. Montage sur pompe avec une ligne gicleur	11923003
	1/8", <1000 kW				

	Oljefilter, Plast 1/4RP 15µM 70313P	Oil filter, Plastic	Ölfilter, Kunststoff	Filtre à fioul, Plastique	11429311 11932301
	För Eo 1 och HVO/XTL	For Fuel oil and HVO/XTL	Für Heizöl und HVO/XTL	Pour l'huile de chauffage et HVO/XTL	
	Filtersats 60200/00015P	Filter set	Filtersatz	Jeu de filtre	12128901
	För filter 11429311	For Filter 11429311	Für Filter 11429311	Pour filtre 11429311	
	Oljefilter ALU 3/8RP 100µM 70311AE, Viton	Oil filter ALU	Ölfilter ALU	Filtre à fioul ALU	11429313 11429303
	För Eo 1, HVO/XTL och FAME/RME	For Fuel oil, HVO/XTL and FAME/ RME	Für Heizöl, HVO/XTL und FAME/RME	Pour l'huile de chauffage, HVO/XTL et FAME/RME	
	Packningssats 3203V, Viton	Gasket set	Dichtungssatz	Kit d'emballage	11885314 11885304
	För filter 11429303, 11429311 och 11429313	For Filter 11429303, 11429311 and 11429313	Für Filter 11429303, 11429311 und 11429313	Pour filtre 11429303, 11429311 et 11429313	
	Oljefilter, Plast 1/4RP 100µM 70452P	Oil filter, Plastic	Ölfilter, Kunststoff	Filtre à fioul, Plastique	11429305 11429306
	För Eo 1 och HVO/XTL	For Fuel oil and HVO/XTL	Für Heizöl und HVO/XTL	Pour l'huile de chauffage et HVO/XTL	
	Packningssats	Gasket set	Dichtungssatz	Kit d'emballage	11885301
	För filter 11429305 och 11429306	For Filter 11429305 and 11429306	Für Filter 11429305 und 11429306	Pour filtre 11429305 et 11429306	
	"Automatisk oljeavlufare med filter Kerosin, För eldningsolja med max 20% bioolja, HVO/XTL <110 l/h, OV COMBI TC3110 Rsk nr: 6469526"	Automatic oil de- aerator with filter <110 l/h, OV COMBI TC3110	Automatische Ontluchter mit Filter <110 l/h, OV COMBI TC3110	Purgeur Automatique avec filtre <110 l/h, OV COMBI TC3110	11748902
	Filter för 11748902 och 11709301 50-75 µm	Filter for 11748902 and 11709301 50-75 µm	Filter für 11748902 und 11709301 50-75 µm	Filtre pour 11748902 et 11709301 50-75 µm	11758901

	Effektregulator, R316 T	Power control, R316 T	Leistungsregler, R316 T	Régulateur de puissance, R316 T	
	PT 100	PT 100	PT 100	PT 100	12052601
	Tryck	Pressure	Druck	Pression	12052602
	Transformator, HDR-15-24 220 VAC/24 VDC	Transformer, HDR-15-24 220 VAC/24 VDC	Transformator, HDR-15-24 220 VAC/24 VDC	Transformateur, HDR-15-24 220 VAC/24 VDC	12133901
	Givare, PT 100	Sensor, PT 100	Fühler, PT 100	Sonde, PT 100	11581902
	Jumo tryckgivare	Jumo pressure transmitter	Jumo Drucktransmitter	Jumo transmetteur de pression	
	0-1 bar	0-1 bar	0-1 bar	0-1 bar	11581905
	0-10 bar	0-10 bar	0-10 bar	0-10 bar	11581906
	0-16 bar	0-16 bar	0-16 bar	0-16 bar	11581907
	Jumo termoelement -200 - 1500	Jumo thermocouple -200 - 1500	Jumo Thermoelement -200 - 1500	Jumo thermocouple -200 - 1500	11581910
	Jumo klämförskruvning termoelement	Jumo compression fitting thermocouple	Jumo, Klemmverschraubung für Thermoelemente	Jumo raccord à vis de serrage pour thermocouples	11581911
	Effektregulator, kapslad, R316 T	Power regulator in device box, R316 T	Leistungsregler im Gerätekasten, R316 T	Régulateur de puissance dans la boîte de l'appareil, R316 T	
	PT 100	PT 100	PT 100	PT 100	12134903
	Tryck	Pressure	Druck	Pression	12134904



CTC AB Box 309 SE-341 26 Ljungby

info@bentone.se +46 372 88 000

www.bentone.se