



Bentone BG 500, BG 600

Reservdelar och tillbehör

Spare Parts and Accessories

Ersatzteile und Zubehör

Pièces détachées et accessoires



MADE IN SWEDEN

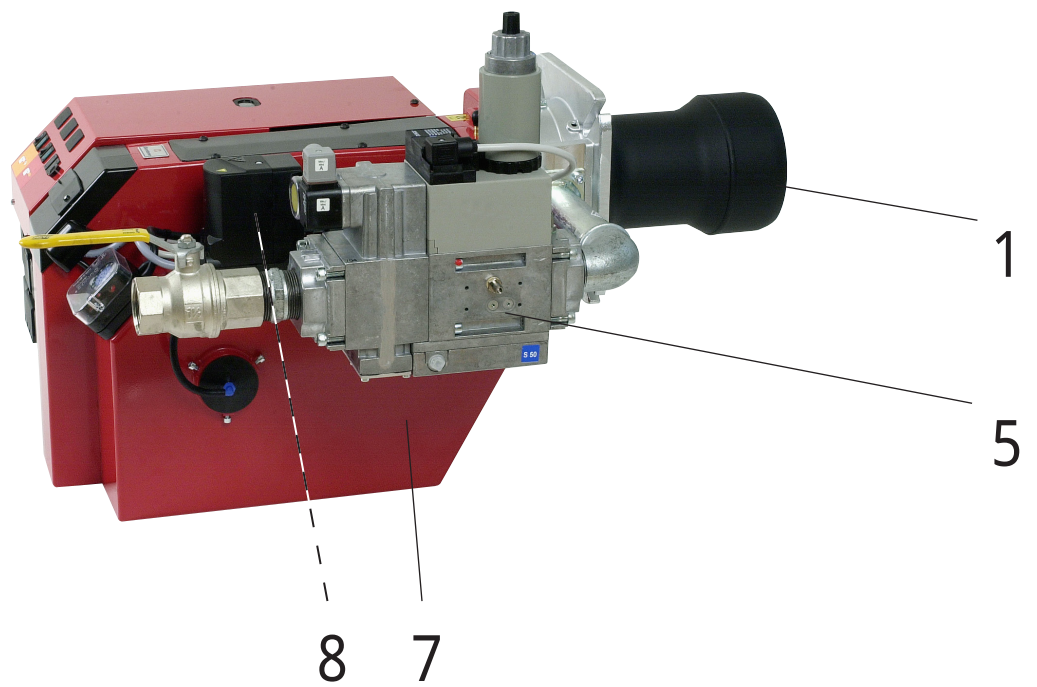
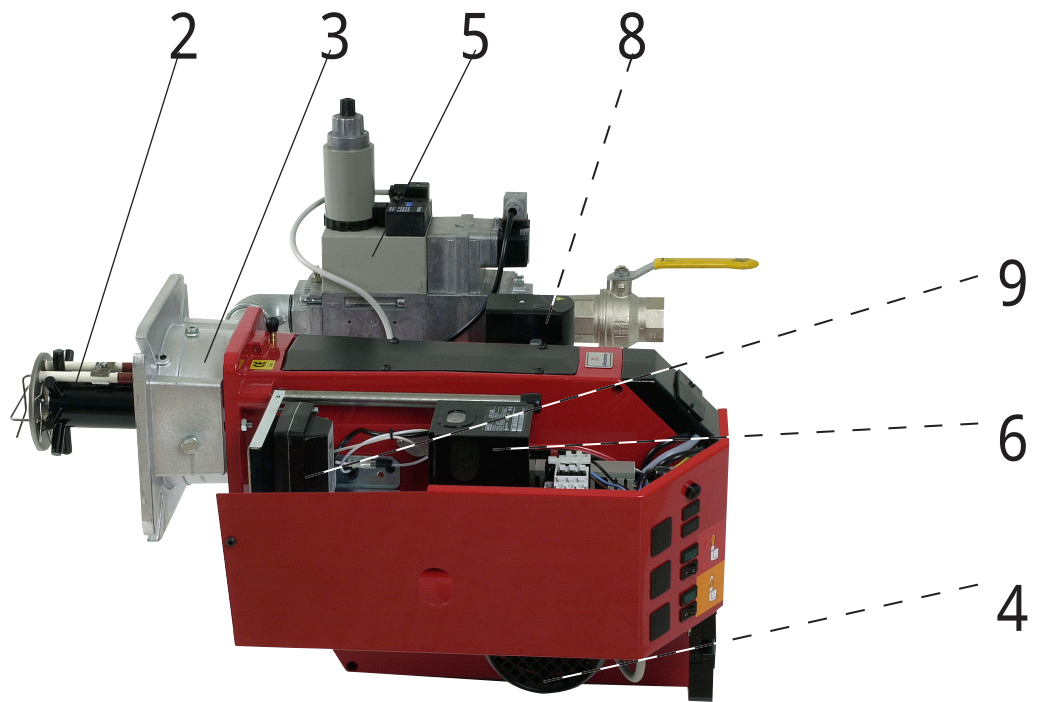







- 1. Brännarrör • Flame tube • Brennerrohr • tube diffuseur 3
- 2. Insats • Nozzle assembly • Düsenstock • Ligne porte-gicleur 4
- 3. Anslutningsfläns • Fixing flange • Anschlussflansch • Bride de fixation 6
- 4. Motor • Motor • Motor • Moteur.....7
- 5. Gaskomponenter • Gas components • Gaskomponenten • Composants de gaz 8
- 6. Elartiklar • Electric components • Elektroteile • Composants électriques 11
- 7. Exteriör • Exterior • Exterieur • Extérieur.....13
- 8. Luftreglering • Air regulation • Luftregelung • Régularisation à air 14
- 9. Transformator • Transformer • Transformator • Transformateur 15



1. Brännarrör • Flame tube • Brennerrohr • tube diffuseur



Brännarrör	Blast tube	Brennerrohr	Tube diffuseur	
BG 500 L = 256 mm	BG 500 256 mm	BG 500 256 mm	BG 500 256 mm	11835801
356 mm	356 mm	356 mm	356 mm	11835802
BG 600 (efter vecka 9804)	BG 600 (after week 9804)	BG 600 (nach Woche 9804)	BG 600 (après la semaine 9804)	
316 mm	316 mm	316 mm	316mm	11831801
416 mm	416 mm	416 mm	416 mm	11831802







2. Insats • Nozzle assembly • Düsenstock • Ligne porte-gicleur

	(efter vecka 9804)	(after week 9804) BG 500	(nach Woche 9804) BG 500	(après la semaine 9804)	
	Insats BG 500	Nozzle assembly BG 500	Düsenstock BG 500	Ligne porte-gicleur BG 500	
	Natur/propangas	LPG/Natural gas	Flüssiggas/Erdgas	Gaz propane/ Gaz naturel	
	Standard	Standard design	Standard	Modèle standard	11865401
	Förlängt utf.	Lengthened design	Verlängerte ausf.	Modèle allongée	11865402
	Stadsgas	Town gas	Stadtgas	Gaz de ville	11865403
	Insats BG 600	Nozzle assembly BG 600	Düsenstock BG 600	Ligne porte-gicleur BG 600	
	Natur/propangas	LPG/Natural gas	Flüssiggas/Erdgas	Gaz propane/ Gaz naturel	
	Standard	Standard design	Standard	Modèle standard	11871501
	Förlängt utf.	Lengthened design	Verlängerte ausf.	Modèle allongée	11871502
	Stadsgas	Town gas	Stadtgas	Gaz de ville	11871503
	Före v.9804 Munstycke kpl	Before w.9804 Nozzle complete.	Vor w.9804. Düse kpl	Avant w.9804 Gicleur complet	
	Joniseringselektrod	Ionisation electrode	Ionisationselektrode	Electrode d'ionisation	91837301
	Ämne	Workpiece	Werkstück	Forme à usiner	11837300
	Tändkabelsats	Ignition Cable Kit	Zündleitungssatz	Kit de fils d'allumage	12026304
	Joniseringskabel-sats	Ignition Cable Kit	Zündleitungssatz	Kit de fils d'allumage	12026314
	O-ring, insatsrör/ munstycke 41,6X2,4	O-ring tube/nozzle 41,6X2,4	O-ring Rohr/Düse 41,6X2,4	Rondelle tube/gicleur 41,6X2,4	11616837
	Bussning, stödrulle	Bushing, backing roller	Buchse, Stützrolle	Douille, stabilisateur	11828501



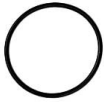

	Isolator, elektrod	Insulator, ignition lectrode	Zündelektrode	Isolateur, electrode d'allumage	11924201
	Bromsskiva	Brakeplate	Stauscheibe	Disque accroche- flamme	
	BG 500	BG 500	BG 500	BG 500	91871601
	BG 600	BG 600	BG 600	BG 600	91871602
	Uv	Uv	Uv	Uv	
	BG 500	BG 500	BG 500	BG 500	11473522
	BG 600	BG 600	BG 600	BG 600	11473523
	Stadsgas	Town gas	Stadtgas	Gaz de ville	
	BG 500	BG 500	BG 500	BG 500	11473520
	BG 600	BG 600	BG 600	BG 600	11743521
		Munstycke	Nozzle	Düse	Gicleur
BG 500		BG 500	BG 500	BG 500	11816003
BG 600		BG 600	BG 600	BG 600	11816004
	Klammer	Bracket	Klammer	Crampon	11273801
	Ställplatta kpl. efter v.9804	Adjustment plate compl. after w.9804	Stellplatte kompl. nach w.9804	Platine de réglage compl. après w.9804	11822902

3. Anslutningsfläns • Fixing flange • Anschlussflansch • Bride de fixation

BENTONE

	Packning, fläns	Gasket, flange	Dichtung, Flansch	Joint, bride	11278808
	Packning, mantel före 9804	Gasket, jacket before 9804	Dichtung, Mantel vor 9804	Joint, manchon avant 9804	11842201
	Packning efter 9804	Gasket after 9804	Dichtung nach 9804	Joint après 9804	
	BG 500	BG 500	BG 500	BG 500	11839701
	BG 600	BG 600	BG 600	BG 600	11839801
	O-ring insatsrör/fläns 54,2X5,7 före 9804	O-ring tube/flange 54,2X5,7 before 9804	O-ring Rohr/Flansch 54,2X5,7 vor 9804	Rondelle tube/bride 54.2X5,7 avant 9804	11316836
	O-ring 44x2,5 efter 9804	O-ring 44x2,5 after 9804	O-ring 44x2,5 nach 9804	Rondelle 44x2,5 après 9804	11316845
	Anslutningsfläns kpl. efter 9804	Fixing flange compl. after 9804	Anschlussflansch kompl. nach 9804	Bride de fixation compl. après 9804	
	BG 500	BG 500	BG 500	BG 500	91874101
	BG 600	BG 600	BG 600	BG 600	91874102
	Anslutningsfläns	Fixing flange	Anschlussflansch	Bride de fixation	
	BG 500	BG 500	BG 500	BG 500	11874101
	BG 600	BG 600	BG 600	BG 600	11874102
	Gejder	Guide bars	Führungsstangen	Barres de guidage	11819301

4. Motor • Motor • Motor • Moteur

	Motor	Motor	Motor	Moteur	
	BG 500	BG 500	BG 500	BG 500	
	0.75/0.90kW 50/60Hz 3-fas	0.75/0.90kW 50/60Hz 3-phase	0.75/0.90kW 50/60Hz 3-phasig	0.75/0.90kW 50/60Hz 3-triphasé	12115201
	BG 600	BG 600	BG 600	BG 600	
	1.5/1.8kW 50/60Hz 3-fas	1.5/1.8kW 50/60Hz 3-phase	1.5/1.8kW 50/60Hz 3-phasig	1.5/1.8kW 50/60Hz 3-triphasé	12115301
	Fläkthjul	Fan wheel	Gebläserad	Rotor	
	BG 500	BG 500	BG 500	BG 500	11806601
	BG 600	BG 600	BG 600	BG 600	11824501
	Motorfläns BG 600	Flange	Flansch	Bride	1180500105
	Avskärningskon	Conical shield	Abschirmkonus	Cône déflecteur d'air	
	BG 500	BG 500	BG 500	BG 500	11805201
	BG 600	BG 600	BG 600	BG 600	11793501

5. Gaskomponenter • Gas components • Gaskomponenten • Composants de gaz

BENTONE

	Gasfilter	Gas filter	Gas-Filter	Filtre gaz	
	1 1/2" 70603/6B	1 1/2" 70603/6B	1 1/2" 70603/6B	1 1/2" 70603/6B	11395405
	2" 70631/6B	2" 70631/6B	2" 70631/6B	2" 70631/6B	11395406
	Filtersats	Filter kit	Filter Kit	Kit de filtre	
	1"-1 1/2" 3217/6B	1"-1 1/2" 3217/6B	1"-1 1/2" 3217/6B	1"-1 1/2" 3217/6B	12143001
	2" 3218/6B	2" 3218/6B	2" 3218/6B	2" 3218/6B	12143002
Gasfilter		Filter kit			
11395403	GASFILTER 1" 70602/6B	12143001	FILTERSATS 1"-1 1/2" 3217/6B		
11395405	GASFILTER 1 1/2" 70603/6B	12143001	FILTERSATS 1"-1 1/2" 3217/6B		
11395406	GASFILTER 2" 70631/6B	12143002	FILTERSATS 2" 3218/6B		
11395407	GASFILTER DN65 70610F/6B	12143003	FILTERSATS DN65-80 3226		
11395408	GASFILTER DN80 70620F/6B	12143003	FILTERSATS DN65-80 3226		
	Fläns med plugg MB410/412 1 1/4"	Flange with plug MB410/412 1 1/4"	Flansch mit Stopfer MB410/412 1 1/4"	Bride avec boulon MB410/412 1 1/4»	11566713
		Mät nipple 1/8"	Test nipple 1/8"	Messnippel 1/8"	Raccord de mesure 1/8»
	Fläns med plugg	Flange with plug	Flansch mit Stopfer	Bride avec boulon	
	1 1/2"	1 1/2"	1 1/2"	1 1/2"	11899201
	2"	2"	2"	2"	11899202
	Kulventil	Ball valve	Kugelhahn	Vanne d'arrêt	
	1 1/2"	1 1/2"	1 1/2"	1 1/2"	11396104
	2"	2"	2"	2"	11396105
	Nippel	Nipple	Nippel	Raccord	
	1/2"				11463701
	1 1/2"				11463703
	2"				11463704
	1 1/2 - 1 1/4"				11463708
	Magnetventil	Solenoid valve	Magnetventil	Electrovanne	
	ZRDLE415/5	ZRDLE415/5	ZRDLE415/5	ZRDLE415/5	11473203
	ZRDLE 420/5	ZRDLE 420/5	ZRDLE 420/5	ZRDLE 420/5	11473204
	Filter	Filter	Filter	Filtre	11916601
	Magnetventil	Solenoid valve	Magnetventil	Electrovanne	
	MVD215/5	MVD215/5	MVD215/5	MVD215/5	11478205
	MVD220/5	MVD220/5	MVD220/5	MVD220/5	11478206
	MVD2065/5	MVD2065/5	MVD2065/5	MVD2065/5	11478207

	Tätchetskontroll VPS 504SO2	Valve, leak tester VPS 504SO2	Dichtkontrolle VPS 504SO2	Controle d'étanchéité VPS 504SO2	11861701	
	Tryckvakt	Pressure switch	Druckwächter	Pressostat		
	GW50A6	GW50A6	GW50A6	GW50A6	91531930	
	GW50A5	GW50A5	GW50A5	GW50A5	11531926	
	LGW50A2	LGW50A2	LGW50A2	LGW50A2	11531907	
	Multiblock MBDLE BG 500	MultiBloc MBDLE BG 500	MultiBloc MBDLE BG 500	MultiBloc MBDLE BG 500		
	412BO1S50	412BO1S50	412BO1S50	412BO1S50	115 670 89	
	Filter	Filter	Filter	Filtre	119 165 01	
	Spole	Coil	Spule	Bobine	115 688 03	
	Multiblock MBZRDLE	MultiBloc MBZRDLE	MultiBloc MBZRDLE	MultiBloc MBZRDLE		
	412BO1S50	412BO1S50	412BO1S50	412BO1S50	115 671 89	
	Filter 410/412	Filter 410/412	Filter410/412	Filtre 410/412	119 165 01	
	415BO1S50 Spole 410/412/415	415BO1S50 Coil 410/412/415	415BO1S50 Spule 410/412/415	415BO1S50 Bobine 410/412/415	115 671 73	
	Steg 1	Stage 1	Stufe 1	1ère allure	115 688 13	
	Steg 2	Stage 2	Stufe 2	2ère allure	115 688 15	
	420BO1S20	420BO1S20	420BO1S20	420BO1S20	115 671 77	
	420BO1S50 Spole 420	420BO1S50 Coil 420	420BO1S50 Spule 420	420BO1S50 Bobine 420	115 671 74	
	Steg 1	Stage 1	Stufe 1	1ère allure	115 688 16	
	Steg 2	Stage 2	Stufe 2	2ère allure	115 688 17	
	Filter 415/420	Filter 415/420	Filter 415/420	Filtre 415/420	119 166 01	
		Multiblock MBVEF	MultiBloc MBVEF	MultiBloc MBVEF	MultiBloc MBVEF	
		412BO1	412BO1	412BO1	412BO1	118 511 04
		Filter 410/412	Filter410/412	Filter 410/412	Filtre 410/412	119 165 01
Spole 412/415		Coil 412/415	Spule 412/415	Bobine 412/415	115 688 23	
415BO1		415BO1	415BO1	415BO1	118 511 08	
420BO1		420BO1	420BO1	420BO1	118 511 09	
Filter 415/420		Filter 415/420	Filter 415/420	Filtre 415/420	119 166 01	
Spole 420		Coil 420	Spule 420	Bobine 420	115 688 24	
425BO1		425BO1	425BO1	425BO1	118 511 07	
Spole 425		Coil 425	Spule 425	Bobine 425	115 688 25	

	Impulsfläns	Impulse flange	Impulsflansch	Bride d'impulsions	
	MBVEF 412	MBVEF 412	MBVEF 412	MBVEF 412	119 684 02
	MBVEF 415	MBVEF 415	MBVEF 415	MBVEF 415	119 684 03
	MBVEF 420	MBVEF 420	MBVEF 420	MBVEF 420	119 684 04
	MBVEF 425	MBVEF 425	MBVEF 425	MBVEF 425	119 684 05
	Impulsrör Ø6,0x1,0 fz metervara	Impulse tube Ø6,0x1,0 fz meter goods	Impulsrohr Ø6,0x1,0 fz meterware	Tube d'impulsions Ø6,0x1,0 fz merchandise de mètre	231 077 00
	Rörkoppling	Screw pipe coupling	Rohranschluss	Raccord de tuyau	
	Vinkel WE6-LLR	Angel WE6-LLR	Winkel WE6-LLR	Coude WE6-LLR	115 452 01
	Rak GE6-LLR	Straight GE6-LLR	Gerade GE6-LLR	Droit GE6-LLR	115 451 01
	Bländare	Diaphragm	Blende	Diaphragme	
	20 mm	20 mm	20 mm	20 mm	119 220 01
	25 mm	25 mm	25 mm	25 mm	119 220 02
	30 mm	30 mm	30 mm	30 mm	119 220 03
	Effektvakt kpl. ÜB50/A2	Power switch compl. ÜB50/A2	Leistungs- begrenzer kompl. ÜB50/A2	Limiteur de puissance compl. ÜB50/A2	119 507 01
	Förbindelserör 1 1/4" kpl. Standard	Connecting pipe 1 1/4" compl. Standard design	Gasrohr 1 1/4" kompl Standard	Tube à gaz 1 1/4" compl. Modèle standard	119 817 01
	Vänster utf. efter w.9804	Left design after w.9804	Links Ausf. nach w.9804	Modèle gauche après w.9804	119 817 02
	Förbindelserör 1 1/2" kpl. Standard	Connecting pipe 1 1/2" compl. Standard design	Gasrohr 1 1/2" kompl Standard	Tube à gaz 1 1/2" compl. Modèle standard	119 432 01
	Vänster utf. efter w.9804	Left design after w.9804	Links Ausf. nach w.9804	Modèle gauche après w.9804	119 432 02
	Bussning, förbindelserör 2"	Nipple, connecting pipe 2"	Nippel, Gasrohr 2"	Raccord, Tube à gaz 2»	115 335 07
	Magnetventil kpl. kontinuerlig fläkt	Solenoid valve compl. continous fan	kompl. kontinuerliches Gebläse	Electrovanne compl. ventilation continue	11923001
	Ersättning för VDK	Replacement for VDK	Ersatz für VDK	Remplacement de VDK	11561802
	Nippel R1/8xG1/8	Nipple R1/8xG1/8	Nippel R1/8xG1/8	Raccord R1/8xG1/8	11469301

6. Elartiklar • Electric components • Elektroteile • Composants électriques

BENTONE

	Reläbox LFL	Control box LFL	Steuergerät LFL	Boîte de contrôle LFL	114 632 04
	Reläsocket LFL kpl.	Relay base LFL compl.	Unterteil LFL kompl.	Socle LFL compl.	114 633 00
	Omkopplare öka-minska	Switch increase-decrease	Umschalter erhöhen-reduzieren	Commutateur augmenter-réduire	117 843 02
	Indikeringslampa	Indicating lamp	Anzeigelampe	Lampe témoin	117 211 03
	UV-cell QRA2	UV-detector QRA2	UV-Detektor QRA2	Cellule UV QRA2	914 634 01
	Säkring 6,3 A	Fuse 6,3 A	Sicherung 6,3 A	Fusible 6,3 A	113 332 01
	Reläsocket LGB, LMG 500-1	Relay base LGB, LMG 500-1	Unterteil LGB 500-1	Socle LGB 500-1	91559600
	Kontaktdon 4+7+5 pol	Plug-in contact 4+7+5 pole	Stecker-vorrichtung 4+7+5 polig	Fiche de prise de courant 4+7+5 polaire	119 486 01
	modulerande	modulating	modulierend	modulant	119 486 12
	Kontaktor LC1D09P7	Contacteur	Kontaktor	Contacteur	12143101
	Överströmsskydd	Thermal overload protection	Überstromschutz	Déclencheur à maxima d'intensité	
	1,6-2,5 A 500	1,6-2,5 A 500	1,6-2,5 A 500	1,6-2,5 A 500	12143206
	2,5-4,0 A 500, 600	2,5-4,0 A 500, 600	2,5-4,0 A 500, 600	2,5-4,0 A 500, 600	12143203

	Strömbrytare 0-1	Switch 0-1	Schalter 0-1	Interrupteur 0-1	12132201
	Strömbrytare 1-11	Switch 1-11	Schalter 1-11	Interrupteur 1-11	12132202
	Omkopplare manuell- automatik	Switch manuel- automatic	Umschalter manuell- automatisch	Commutateur manuel- automatique	12132203
	Kontaktton handel 7 pol	Plug-in contact female 7 pole	Buchsenteil 7 polig	Prise "européenne" femelle 7 polaire	915 585 01
	Kontaktton handel 7 pol	Plug-in contact male 7 pole	Steckerteil 7 polig	Prise "européenne" mâle 7 polaire	115 585 00
	Kontaktton handel 4 pol	Plug-in contact male 4 pole	Steckerteil 4 polig	Fiche de prise de courant mâle 4 polaire	119 197 01
	Kontaktton handel 4 pol	Plug-in contact female 4 pole	Buchsenteil 4 polig	Fiche de prise de courant femelle 4 polaire	119 198 01
	Kontaktton	Plug-in contact	Steckerteil	Fiche de prise de courant	
	handel 5 pol	male 5 pole	5 polig	mâle 5 polaire	119 199 01
	handel 5 pol	female 5 pole	Buchsenteil 5 polig	femelle 5 polaire	119 200 01
	Säkringshållare kpl.	Fuse holder compl.	Sicherungshalter kompl.	Support de fusée compl.	118 118 03
	Kontaktton hona 18309	Plug-in contact female 18309	Buchsenteil 18309	Fiche de prise de courant femelle 18309	114 216 03
	Kontaktton hona 183.2	Plug-in contact female 183.2	Buchsenteil 183.2	Fiche de prise de courant femelle 183.2	114 216 14

7. Exteriör • Exterior • Extérieur • Extérieur

BENTONE



	Lock 600	Cover 600	Deckel 600	Couvercle 600	118238 0105
	Packing 600	Gasket 600	Dichtung 600	Joint 600	118 249 01
	Inspektionsglas	Inspection glass	Schauglas	Viseur de flamme	118 088 01
	Packing, inspek- tionsglas	Gasket, inspection glass	Dichtung, Schauglas	Joint, viseur de flamme	117 953 01
	Säkringsring	Locking ring	Sicherungsring	Circlip	118 018 01
	Inspektionslock	Cover	Deckel	Couvercle	117 080 01
	Lock	Cover	Deckel	Couvercle	111 731 01
	Kåpa 500	Cover 500	Haube 500	Capot 500	117 963 0205
	Kåpa 600	Cover 600	Haube 600	Capot 600	118 242 0205
	Skyddsgaller 500	Protective grating 500	Schutzgitter 500	Grille protectrice 500	117 949 01
	Skyddsgaller 600	Protektive grating 600	Schutzgitter 600	Grille protectrice 600	118 319 01

8. Luftreglering • Air regulation • Luftregelung • Régularisation à air

BENTONE

	Luftspjäll kpl.	Air damper compl.	Luftklappe kompl.	Volet d'air compl.	
	500-1	500-1	500-1	500-1	917 992 11
	500-2, 500-M	500-2, 500-M	500-2, 500-M	500-2, 500-M	917 992 02
	Luftspjäll kpl.	Air damper compl.	Luftklappe kompl.	Volet d'air compl.	
	600	600	600	600	918 240 01
	Pinnskruv, spjällmotor	Stud screw, damper motor	Stiftschraube, Stellmotor	Vis à goupille, servo moteur	119 203 01
	Fästplatta	Covering plate	Deckplatte	Plaque de recouvrement	
	500-1	500-1	500-1	500-1	118 528 0105
	500-2	500-2	500-2	500-2	117 978 0105
	600	600	600	600	118 239 0105
	Nippel,tryckvakt	Nipple,pressure switch	Nippel, Druckwächter	Raccord, pressostat	115 423 01
	Slangnippel	Hose nipple	Schlauchnippel	Raccord de tuyau flexible	115 753 01
	Visare 500-1	Pointer 500-1	Zeiger 500-1	Index 500-1	118 363 01
	Skala 500-1	Scale 500-1	Skala 500-1	Echelle 500-1	112 752 03
	Länkarm kpl.	Slewing bracket compl.	Gelenkarm compl	Pivot compl.	119 470 01
	Spjällmotor	Damper motor	Stellmotor	Servo moteur	
	Landis & Staefa SQN75.664A21B	Landis & Staefa SQN75.664A21B	Landis & Staefa SQN75.664A21B	Landis & Staefa SQN75.664A21B	119 423 05
	LFL modulerande SQN75.294A21B LFL	LFL modulating SQN75.294A21B LFL	LFL modulierend SQN75.294A21B LFL	LFL modulant SQN75.294A21B LFL	119 423 03
	SQN75.215A21B TMG	SQN75.215A21B TMG	SQN75.215A21B TMG	SQN75.215A21B TMG	119 423 08
	Plugg kpl. med nippel efter 0239	Covering plug comp. with nipple after W0239	Stopfe kompl. mit Nippel nach W0239	Tampon compl. avec raccord après 0239	119 209 12

9. Transformator • Transformer • Transformator • Transformateur

	Transformator UV	Transformer UV	Transformator UV	Transformateur UV	118 046 01
	Transformator standard kpl	Transformer standard design compl	Transformator Standard kompl	Transformateur Modèle standard compl	118 523 03
	Kabel	Cable	Kabel	Câble	118 047 02
	Fäste	Fixing plate	Befestigungs-platte	Platine de fixation	118 086 01



CTC AB Box 309 SE-341 26 Ljungby

info@bentone.se +46 372 88 000

www.bentone.se