



## **Bentone BG 300, BG 400**

Reservdelar och tillbehör

Spare Parts and Accessories

Ersatzteile und Zubehör

Pièces détachées et accessoires



MADE IN SWEDEN

## Innehåll - Index - Inhalt - Sommaire

1. Brännarrör - Flame tube - Brennerrohr - Tube de brûleur	_ 3
2. Insats - Nozzle assembly - Düsenstock - Ligne porte-gicleur	4
3. Motor - Motor - Motor - Moteur	_____ 8
4. Gasventil - Gas Valve - Gasventil - Vanne de gaz - (MultiBloc)	9
5. Elkomponenter - Electrical - Elektrische - Électriques	_____ 14
6. Exteriör - Exterior - Exterieur - Extérieur	_____ 18
7. Luftreglering - Air control - Luftsteuerung	
- Régularisation à air	_____ 20
8. Övrigt - Sundries - Verschiedenes - Divers	_____ 21

# 1. Brännarrör - Flame tube - Brennerrohr - Tube de brûleur

Namn	Name	Name	Nom	Information	Artikel nr
1 Brännarrör	Flame tube	Brennerrohr	Tube de brûleur	L=245 mm, BG300	0011751803
3 Brännarrör	Flame tube	Brennerrohr	Tube de brûleur	L=172 mm, BG400	0011751901
3 Brännarrör	Flame tube	Brennerrohr	Tube de brûleur	L=272 mm, BG400	0011751903
3 Brännarrör	Flame tube	Brennerrohr	Tube de brûleur	L=372 mm, BG400	0011751904
5 Brännarrör	Flame tube	Brennerrohr	Tube de brûleur	L=230 mm, BG400 LN	0011962601

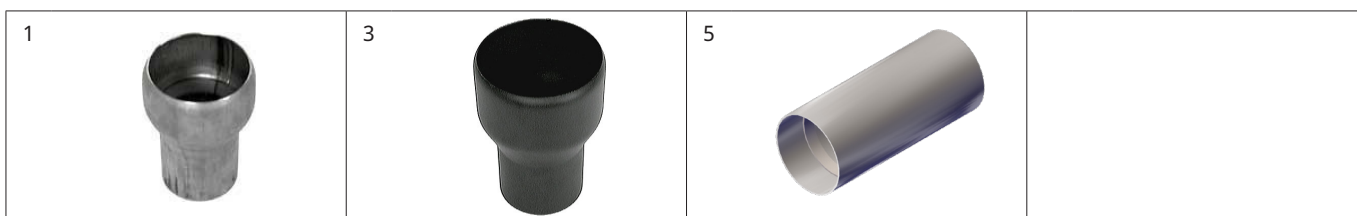

## 2. Insats - Nozzle assembly - Düsenstock - Ligne porte-gicleur

Namn	Name	Name	Nom	Information	Artikel nr
1 Insats kompl.	Nozzle assembly compl.	Düsenstock kompl.	Ligne porte-gicleur compl.	BG 300	0011804401
1 Insats kompl. långt utf	Nozzle assembly compl. long design	Düsenstock kompl. lange Ausführung	Ligne porte-gicleur compl. modèle long	BG 300	0011804403
3 Insats kompl.	Nozzle assembly compl.	Düsenstock kompl.	Ligne porte-gicleur compl.	BG 400	0011804501
3 Insats kompl. långt utf	Nozzle assembly compl. long design	Düsenstock kompl. lange Ausführung	Ligne porte-gicleur compl. modèle long	BG 400	0011804503
3 Insats kompl. extra långt utf	Nozzle assembly compl. extra long design	Düsenstock kompl. extra lange Ausführung	Ligne porte-gicleur compl. modèle extra long	BG 400	0011804504
6 Bromsskiva med gasmunstycke	Brake plate with gas nozzle	Stauscheibe mit Gasdüse	Disque accroche-flamme avec gicleur gaz	BG 300	0011797002
6 Bromsskiva med gasmunstycke	Brake plate with gas nozzle	Stauscheibe mit Gasdüse	Disque accroche-flamme avec gicleur gaz	BG 400	0011797001
8 Bromsskiva	Brake plate	Stauscheibe	Disque accroche-flamme	BG 300	0011754401
8 Bromsskiva	Brake plate	Stauscheibe	Disque accroche-flamme	BG 400	0011754402
8 Bromsskiva med nit	Brake plate with rivet	Stauscheibe mit Niet	Disque accroche-flamme avec rivet	BG 300	0091941801
8 Bromsskiva med nit	Brake plate with rivet	Stauscheibe mit Niet	Disque accroche-flamme avec rivet	BG 400	0091941802
11 Gasmunstycke	Gas nozzle	Gasdüse	Gicleur gaz	BG 300	0011796802
11 Gasmunstycke	Gas nozzle	Gasdüse	Gicleur gaz	BG 400	0011796807

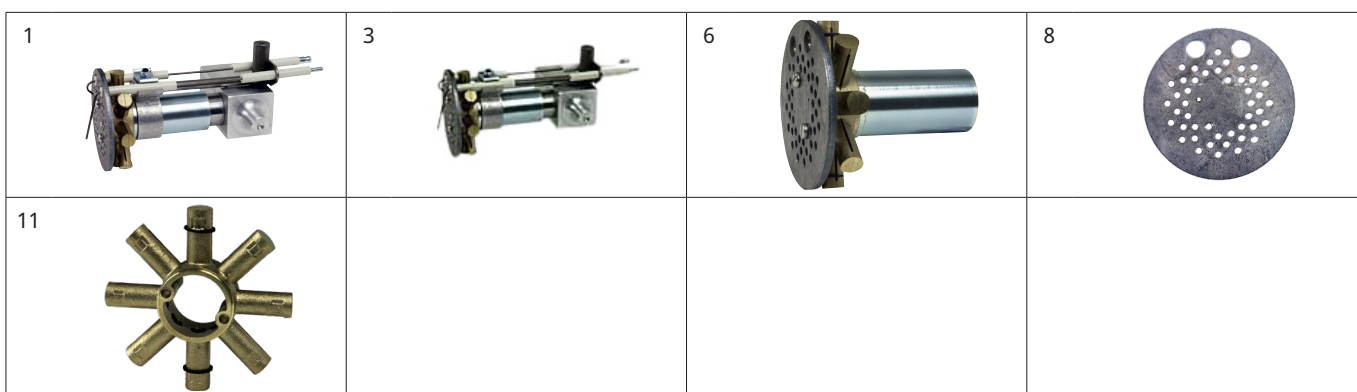

## 2. Insats - Nozzle assembly - Düsenstock - Ligne porte-gicleur

Namn	Name	Name	Nom	Information	Artikel nr
13 Dragstång kpl.	Pull rod compl.	Zugstange kompl.	Barre de traction compl.		0011930601
13 Dragstång kpl. långt utf.	Pull rod compl. long design	Zugstange kompl. lange Ausführung	Barre de traction compl. modèle long		0011930602
13 Dragstång kpl. extra långt utf	Pull rod compl. extra long design	Zugstange kompl. extra lange Ausführung	Barre de traction compl. modèle extra long		0011930603
15 Elektrodhållare	Electrode holder	Elektrodenhalter	Porte-électrode		0011719601
17 Joniseringselektrod	Ionization electrode	Ionisationselektrode	Electrode d'ionisation	L=182	0011905102
17 Joniseringselektrod långt utf.	Ionization electrode long design	Ionisationselektrode lange Ausführung	Electrode d'ionisation modèle long	L=282	0011905106
17 Joniseringselektrod extra långt utf	Ionization electrode extra long design	Ionisationselektrode extra lange Ausführung	Electrode d'ionisation modèle extra long	L=388	0011905110
19 Tändelektrod	Ignition electrode	Zündeletrode	Electrode d'allumage	L=182	0011905101
19 Tändelektrod långt utf.	Ignition electrode long design	Zündeletrode lange Ausführung	Electrode d'allumage modèle long	L=282	0011905105
19 Tändelektrod extra långt utf	Ignition electrode extra long design	Zündeletrode extra lange Ausführung	Electrode d'allumage modèle extra long	L=388	0011905109
22 Klammer	Bracket	Klammer	Crampon		0011273801
24 Klammer långt utf.	Bracket long design	Klammer lange Ausführung	Crampon modèle long		0439017224
27 O-ring	O-ring	O-ring	Joint torique	Nitril, 25.2x3	0011316838
29 O-ring	O-ring	O-ring	Joint torique	Nitril, 23.52x1.78	0011316801







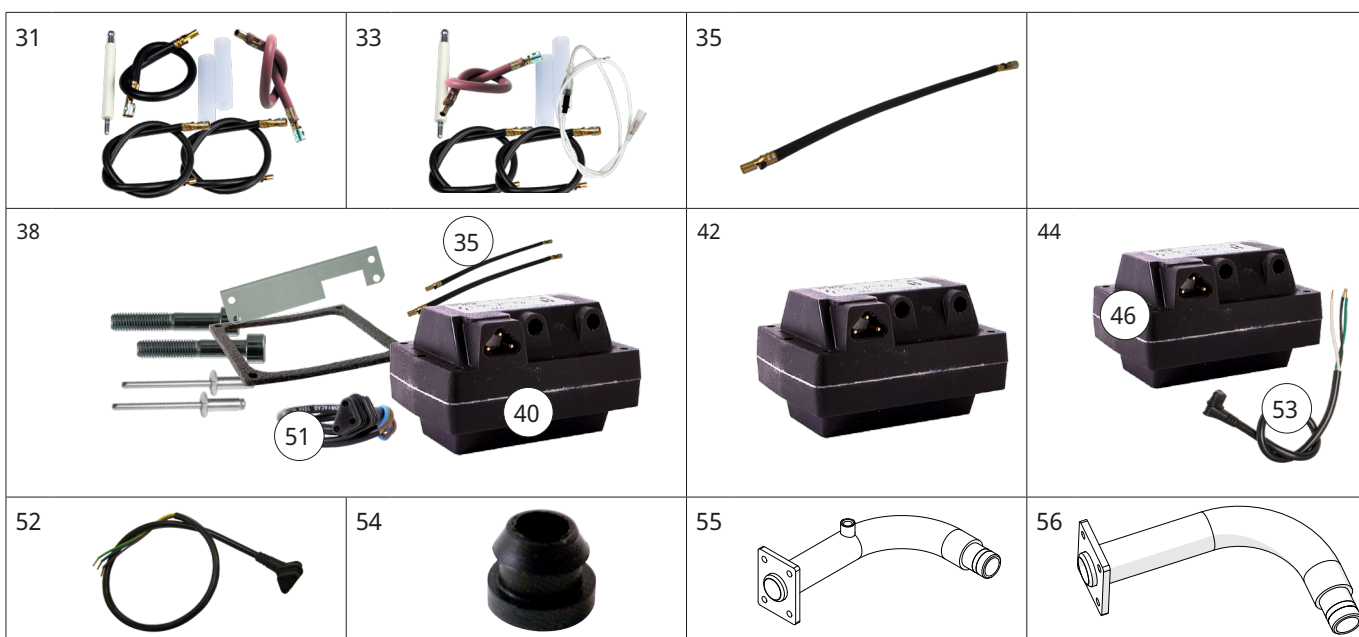

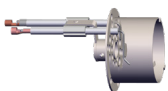

## 2. Insats - Nozzle assembly - Düsenstock - Ligne porte-gicleur

Namn	Name	Name	Nom	Information	Artikel nr
31 Tändkabelsats	Ignition Cable Kit	Zündleitungssatz	Kit de fils d'allumage		0012026304
33 Joniseringskabel, sats	Ignition Cable Kit	Zündleitungssatz	Kit de fils d'allumage		0012026314
35 Resistanständkabel	Ignition cable	Zündkabel	Câble H.T	L=350 mm, BG300, BG400	0012074935
38 Transformator, kompl.	Transformer compl.	Transformator kompl.	Transformateur compl.	Fida, BG300	0011852303
40 Transformator	Transformer	Transformator	Transformateur	Fida	0011835301
42 Transformator, biogas	Transformer, biogas	Transformator, Biogas	Transformateur, Biogaz	Fida	0011804601
44 Transformator, kompl.	Transformer compl.	Transformator kompl.	Transformateur compl.	Flynn, UL, 120V	0011852304
46 Transformator	Transformer	Transformator	Transformateur	Flynn, UL, 120V	0011835304
51 Kabel, transformator	Cable, transformer	Kabel, Transformator	Câble, transformateur	FIDA L=700mm, BG300	0011804702
52 Kabel, transformator, vinklad	Cable, transformer, angled	Kabel, Transformator, abgewinkelt	Câble, transformateur, coudé	L=450mm, BG400	0011977101
53 Kabel, transformator, vinklad	Cable, transformer, angled	Kabel, Transformator, abgewinkelt	Câble, transformateur, coudé	Flynn L=450mm	0011977106
54 Kabelgenomföring	Cable inlet	Kabeldurchführung	Douille de passage câble		0004300401
55 Förbindelserör, med mätuttag	Connecting pipe, measuring point	Öldruckrohr, Messbuchse	Conduite de raccordement, prise de mesure	1", 179,5 mm, BG 300, BG 400	001194300105
56 Förbindelserör	Connecting pipe	Öldruckrohr	Conduite de raccordement	3/4", 179,5 mm, BG 300, BG 400	001198150105

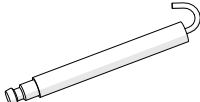

## 2. Insats - Nozzle assembly - Düsenstock - Ligne porte-gicleur

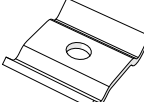
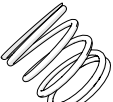
Namn	Name	Name	Nom	Information	Artikel nr
60 Bromsskiva med elektrod	Brake plate with electrode	Stauscheibe mit Elektrode	Disque accroche-flamme avec électrode	BG 400 LN	0012123901
62 Bromsskiva	Brake plate	Stauscheibe	Disque accroche-flamme	BG 400 LN	0012128801
64 Gasmunstycke	Gas nozzle	Gasdüse	Gicleur gaz	BG 400 LN	0012123401
68 Joniseringselektrod	Ionization electrode	Ionisationselektrode	Electrode d'ionisation	BG 400 LN	0011534707
70 Tändelektrod	Ignition electrode	Zündelektrode	Electrode d'allumage	BG 400 LN	0011534713
72 Isolator	Insulator	Isolator	Isolant	BG 400 LN	0011924201
74 Tänd- och joniseringskabel	Ignition and ionisation cable	Zünd- und Ionisationskabel	Câble H.T. et Câble d'ionisation	L=150, BG 400 LN	0012074815
76 Klammer, justerbart lås	Bracket, adjustable lock	Klammer, einstellbares Schloss	Crampon, Serrure réglable	LDS, BG 400 LN	0011155201
78 Tryckfjäder	Pressure spring	Druckfeder	Ressort de pression	1.6x20x48 DIN 2098, BG 400 LN	0011968104
80 O-ring	O-ring	O-ring	Joint torique	18x2, BG 400 LN	0011316847

60		62		64		68	
70		72		74		76	
78		80					

### 3. Motor - Motor - Motor - Moteur

Namn	Name	Name	Nom	Information	Artikel nr
1 Motor med kabel	Motor with cable	Motor, mit Kabel	Moteur, avec câble	180 W, 230V, 50/60 Hz, 5µF, 1F, Hanning, BG 300	0092090301
4 Motor	Motor	Motor	Moteur	260 W, 50/60 Hz, 8µF, 1F, Simel, BG 300	0012132601
7 Motor med kabel	Motor with cable	Motor, mit Kabel	Moteur, avec câble	250 W, 50/60 Hz, 8µF, 1F, Hanning, BG 400	0092090201
10 Motor	Motor	Motor	Moteur	350 W, 50/60 Hz, 10µF, 1F, BG 400	0012091201
12 Motorkabel	Cable motor	Kabel Motor	Câble moteur		0012086601
15 Fläkthjul	Fan wheel	Gebbläserad	Rotor	146X52X12.7, BG 300	0011277608
15 Fläkthjul	Fan wheel	Gebbläserad	Rotor	160X62X12.7, BG 400 till/to/zu/á: 0013	0011277609
15 Fläkthjul	Fan wheel	Gebbläserad	Rotor	160X75X12.7, BG 400 från/from/ab/de: 0014	0011277621
20 Motorfläns	Flange, motor	Flansch, motor	Bride, moteur	BG 300	0011700901
25 Kondensator	Capacitor	Kondensator	Condensateur	5 µF, 180 W, BG 300, Hanninh, BG400	0012093101
27 Kondensator	Capacitor	Kondensator	Condensateur	8 µF, 260 W, Simel, BG 300	0012093201
29 Kondensator	Capacitor	Kondensator	Condensateur	8 µF, Simel, BG 400	0012133101
31 Kondensator	Capacitor	Kondensator	Condensateur	10 µF, Simel, BG 400	0012093901

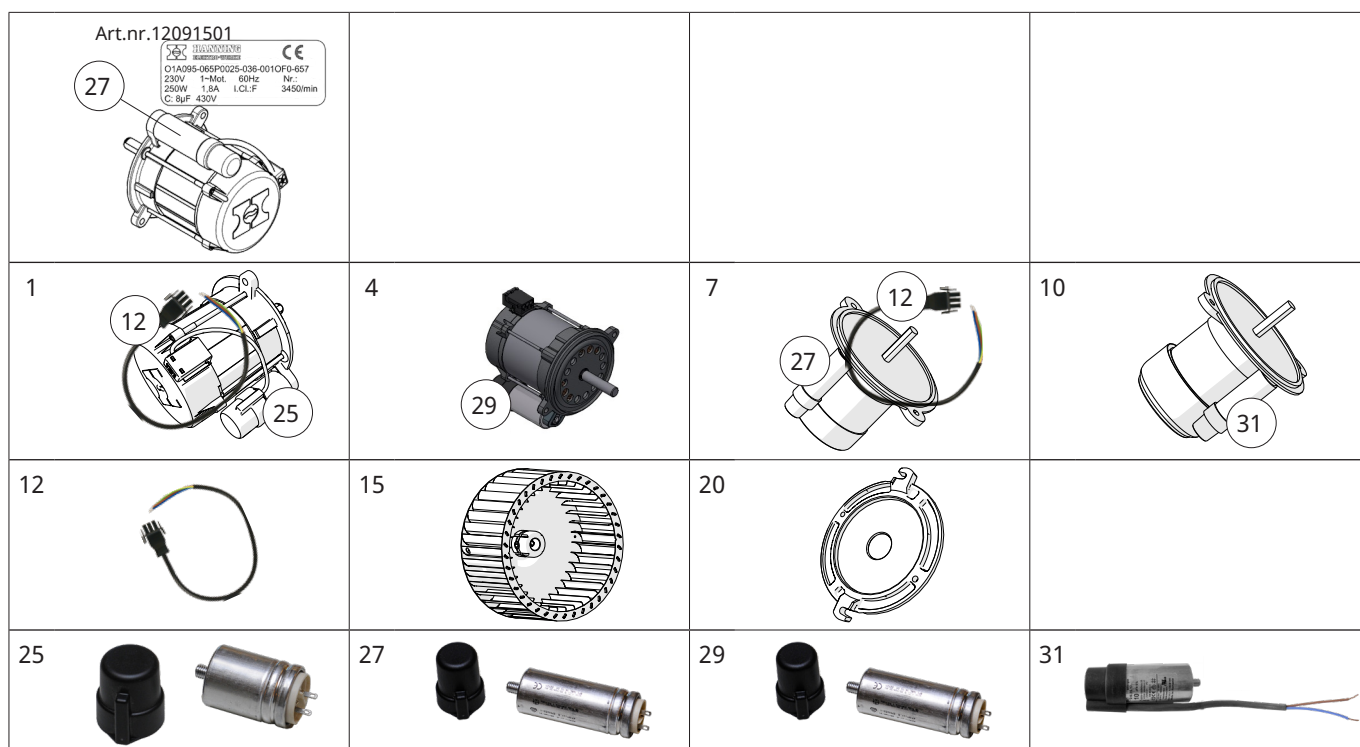



## 4. Gasventil - Gas Valve - Gasventil - Vanne de gaz - (MultiBloc)

Namn	Name	Name	Nom	Information	Artikel nr
2 Gasventil (MultiBloc)	Gas valve (MultiBloc)	Gasventil (MultiBloc)	Vanne de gaz (MultiBloc)	MB DLE 407 B01 S50 GW150, BG 300. BG 400	0011567071
5 Gasventil (MultiBloc)	Gas valve (MultiBloc)	Gasventil (MultiBloc)	Vanne de gaz (MultiBloc)	MB DLE 412 B01 S50 GW150, BG 300. BG 400	0011567089
5 Gasventil (MultiBloc)	Gas valve (MultiBloc)	Gasventil (MultiBloc)	Vanne de gaz (MultiBloc)	MB DLE 420 B01 S50 GW50A5, BG 300. BG 400	0011567077
7 Gasventil (MultiBloc)	Gas valve (MultiBloc)	Gasventil (MultiBloc)	Vanne de gaz (MultiBloc)	MB VEF 407 B01 S30, BG 300M. BG 400M	0011851102
9 Gasventil (MultiBloc)	Gas valve (MultiBloc)	Gasventil (MultiBloc)	Vanne de gaz (MultiBloc)	MB VEF 412 B01 S30, BG 300M, BG 400M	0011851104
11 Gasventil (MultiBloc)	Gas valve (MultiBloc)	Gasventil (MultiBloc)	Vanne de gaz (MultiBloc)	MB ZRDLE 407 BO1S50, BG 300-2, BG 400-2	0011567171
13 Gasventil (MultiBloc)	Gas valve (MultiBloc)	Gasventil (MultiBloc)	Vanne de gaz (MultiBloc)	MB ZRDLE 412 BO1S50, BG 300-2, BG 400-2	0011567189
13 Gasventil (MultiBloc)	Gas valve (MultiBloc)	Gasventil (MultiBloc)	Vanne de gaz (MultiBloc)	MB ZRDLE 415 BO1S20, BG 300-2, BG 400-2	0011567176
20 Magnetventil, biogas	Solenoid valve, biogas	Magnetventil, Biogas	Électrovanne, biogaz	DMV-DLE 507/11	0011979802
20 Magnetventil, biogas	Solenoid valve, biogas	Magnetventil, Biogas	Électrovanne, biogaz	DMV-DLE 512/11	0011979803

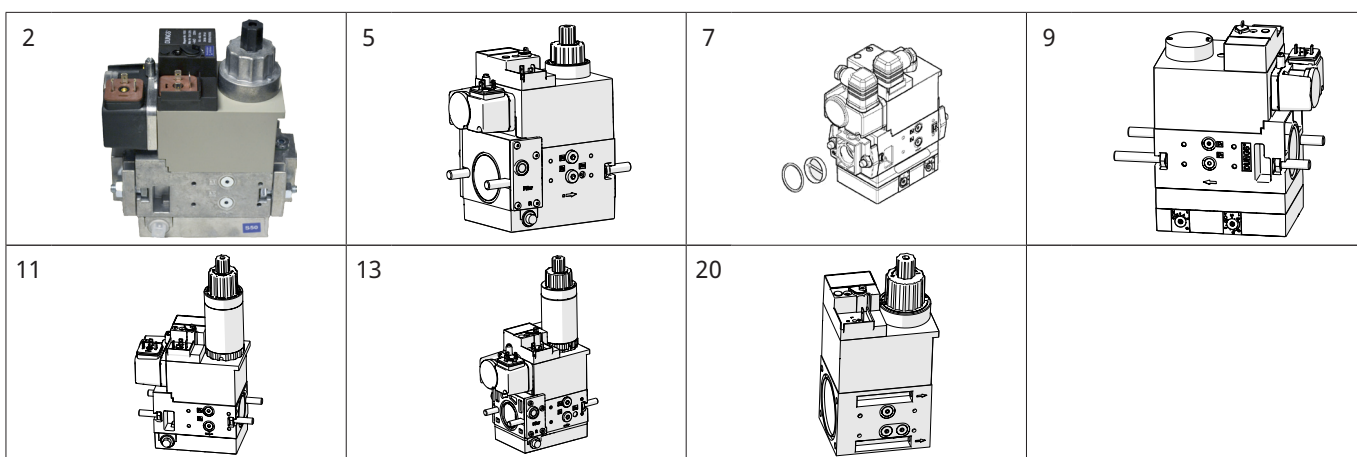

## 4. Gasventil - Gas Valve - Gasventil - Vanne de gaz - (MultiBloc)

Namn	Name	Name	Nom	Information	Artikel nr
30 Fläns	Flange	Flansch	Bride	3/4", 405/407	0011566703
32 Fläns med mätnippel	Flange with test nipple	Flansch mit Messnippel	Bride avec connecteur de test	3/4", 405/407	0011566708
34 Fläns	Flange	Flansch	Bride	1 1/4", 410/412	0011566713
36 Fläns med mätnippel	Flange with test nipple	Flansch mit Messnippel	Bride avec connecteur de test	1 1/4", 410/412	0011566718
38 Fläns	Flange	Flansch	Bride	1", 410/412	0011566712
40 Fläns med mätnippel	Flange with test nipple	Flansch mit Messnippel	Bride avec connecteur de test	1", 410/412	0011566717
43 Fläns	Flange	Flansch	Bride	1 1/2"	0011899201
43 Fläns	Flange	Flansch	Bride	2"	0011899202
43 Fläns	Flange	Flansch	Bride	1", DMW	0011899205
47 Impulsfläns	Impulse flange	Impulsflansch	Bride d'impulsions	VEF 407	0011968401
47 Impulsfläns	Impulse flange	Impulsflansch	Bride d'impulsions	VEF 412	0011968402
47 Impulsfläns	Impulse flange	Impulsflansch	Bride d'impulsions	VEF 415	0011968403
47 Impulsfläns	Impulse flange	Impulsflansch	Bride d'impulsions	VEF 420	0011968404
50 Filtersats	Filter set	Filtersatz	Jeu de filtre	405/407	0011916401
52 Filtersats, rektangulärt	Filter set rectangular	Filtersatz rechteckig	Jeu de filtre rectangulaire	410/412	0011916501
54 Filtersats, cirkulärt	Filter set circular	Filtersatz kreisförmig	Jeu de filtre circulaire	410/412	0011916511
56 Filtersats	Filter set	Filtersatz	Jeu de filtre	415/420	0011916601

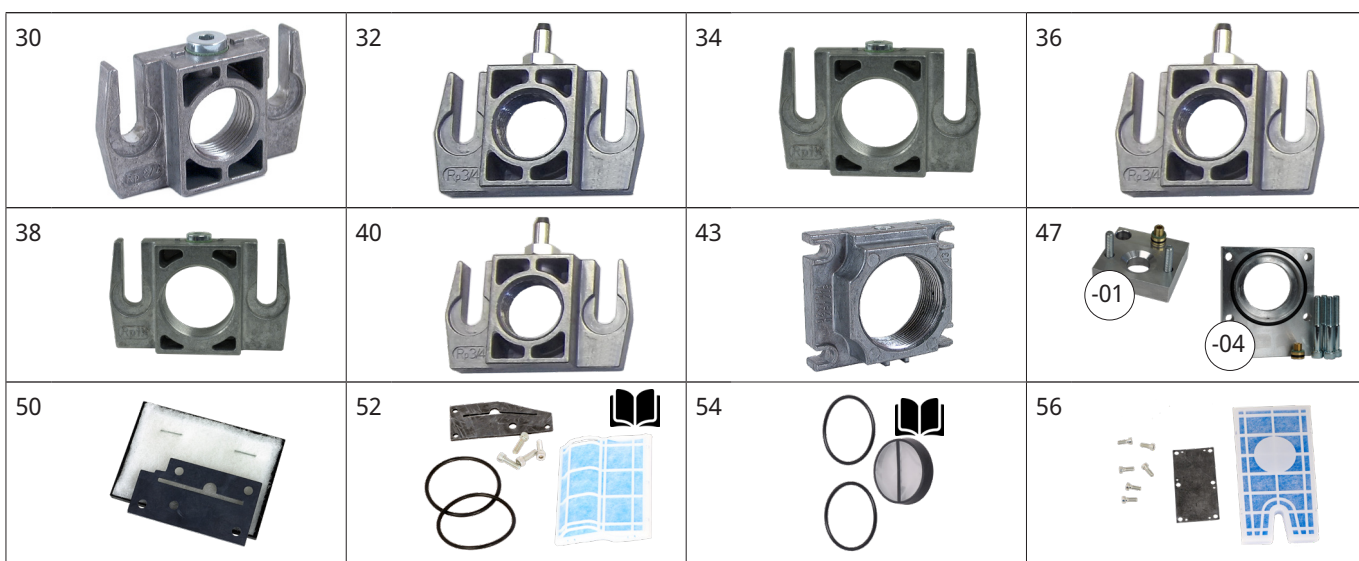

## 4. Gasventil - Gas Valve - Gasventil - Vanne de gaz - (MultiBloc)

Namn	Name	Name	Nom	Information	Artikel nr
58 Filtersats	Filter set	Filtersatz	Jeu de filtre	MB-DLE 415/407, MB-ZRDLE 405/407, MB-VEF 405/407	0011916411
61 Gasventil (MultiBloc)	Gas valve (MultiBloc)	Gasventil (MultiBloc)	Vanne de gaz (MultiBloc)	DLE 407 B07S22 GW 150 A5	0011567066
63 Gasventil (MultiBloc)	Gas valve (MultiBloc)	Gasventil (MultiBloc)	Vanne de gaz (MultiBloc)	DLE 412 B07S22 GW 150 A5	0011567064
65 Gasventil (MultiBloc)	Gas valve (MultiBloc)	Gasventil (MultiBloc)	Vanne de gaz (MultiBloc)	ZRDLE 412 B07S22 GW 150	0011567164
68 Spole Steg1	Coil Stage 1	Spule Stufe 1	Bobine 1ère étape	405/407B07S22 1120	0011568807
68 Spole Steg1	Coil Stage 1	Spule Stufe 1	Bobine 1ère étape	410/412B07S22 1220	0011568808
68 Spole Steg2	Coil Stage 2	Spule Stufe 2	Bobine 2ème allure	410/412B07S22 1220	0011568809
68 Spole Steg1	Coil Stage 1	Spule Stufe 1	Bobine 1ère étape	ZRDLE 405/407	0011568812
68 Spole Steg2	Coil Stage 2	Spule Stufe 2	Bobine 2ème allure	ZRDLE 405/407	0011568814
68 Spole Steg1	Coil Stage 1	Spule Stufe 1	Bobine 1ère étape	ZRDLE 410/412/415	0011568813
68 Spole Steg2	Coil Stage 2	Spule Stufe 2	Bobine 2ème allure	ZRDLE 410/412/415	0011568815
72 Magnetventilkabel	Cable, solenoid valve	Kabel, Magnetventil	Câble, électrovanne	4X0,75 L=1100, DLE, B07, ZRDLE	0011951003
74 Switch	Switch	Schalter	Commutateurs	CPI DU 211202	0012109401
76 Tryckvakt	Pressure switch	Druckwächter	Pressostat	LGW 50A2 2,5-50 MBAR	0011531907
77 Tryckvakt	Pressure switch	Druckwächter	Pressostat	QPL25.050	0012079713
78 Tryckvakt	Pressure switch	Druckwächter	Pressostat	GW 150A5, 10-150 MBAR	0011531927
78 Tryckvakt	Pressure switch	Druckwächter	Pressostat	GW 150A5, 5-50 MBAR	0011531926

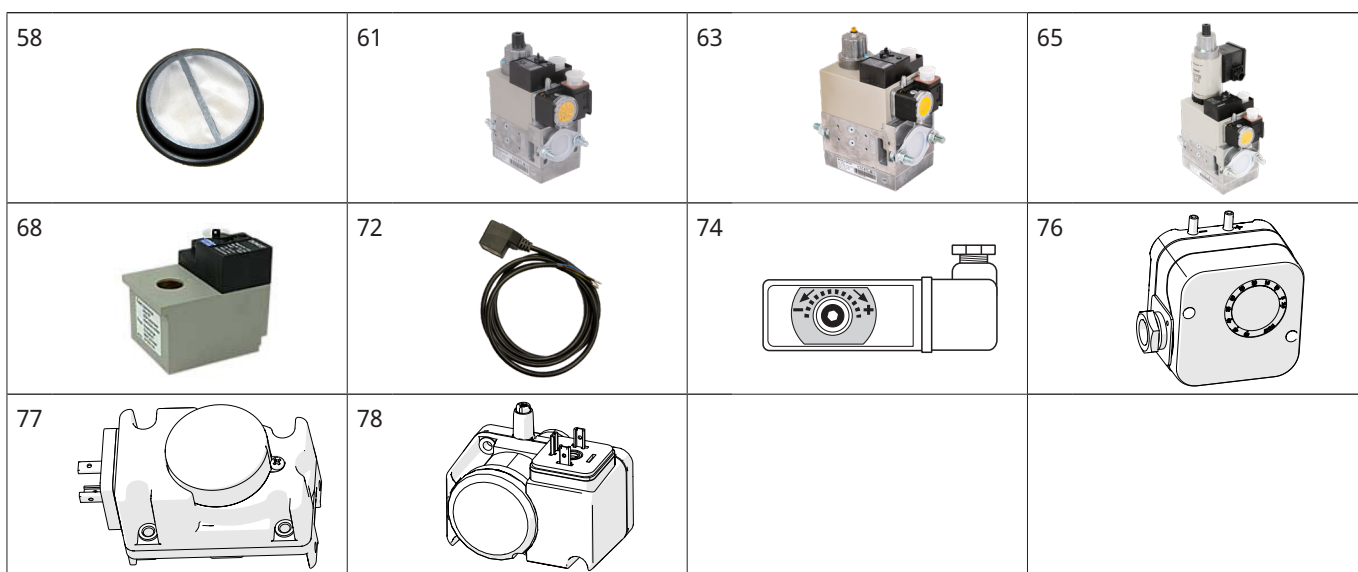

## 4. Gasventil - Gas Valve - Gasventil - Vanne de gaz - (MultiBloc)

Namn	Name	Name	Nom	Information	Artikel nr
80 Tryckvakt medkontaktdon	Pressure switch with plug-in contact	Druckwächter mit Stecker und Buchsenteil	Pressostat avec fiche de Prise de courant	GW 150A6	0091531930
82 Cable, tryckvakt	Kabel, pressure switch	Câble, Druckwächter	Kabel, pressostat	3x0.75 L=590	0011951113
82 Cable, tryckvakt	Kabel, pressure switch	Câble, Druckwächter	Kabel, pressostat	3x0.75 L=750	0011951110
83 Cable, luftvakt	Kabel, air switch	Câble, Luftwächter	Kabel, pressostat d'air	4x0.75 L=600	0011949704
84 Magnetventil, kontinuerlig fläkt	Solenoid valve, continous fan	Magnetventil, kontinuerliches Gebläse	Electrovanne, ventilation continue		0011923001
85 Täthetskontroll	Leakage control	Dichtkontrolle	Contrôle d'étanchéité	VPS 504202	0011861701
86 Täthetskontroll komplett	Leakage control compl.	Dichtkontrolle kompl.	Contrôle d'étanchéité compl.	VDK-VPS 504202, Biogas	0011561802
87 Effektvakt	Power switch	Leistungsbegrenzer	Limiteur de puissance	ÜB50/A2	0011950701
88 Cable, effektvakt	Kabel, power switch	Câble, Leistungsbegrenzer	Kabel, limiteur de puissance	4x0.75 L=2000	0012142015
89 Gasfilter	Gas filter	Gas-Filter	Filtre gaz	GF515/1,1 1/2", BG 300	0011395415
89 Gasfilter	Gas filter	Gas-Filter	Filtre gaz	GF520/1,2", BG 400	0011395416
90 Restriktor, flödesjustering, biogas	Restrictor, flow regulation, bio gas	Gegrenzer, Flussregelung, Biogas	Limiteur, réglage de flux, Biogaz		0011996501
91 Kulventil, rak	Ball valve, straight	Kugelhahn, gerade	Vanne à boule, droite	1"	0011396102
91 Kulventil, rak	Ball valve, straight	Kugelhahn, gerade	Vanne à boule, droite	1 1/2"	0011396104

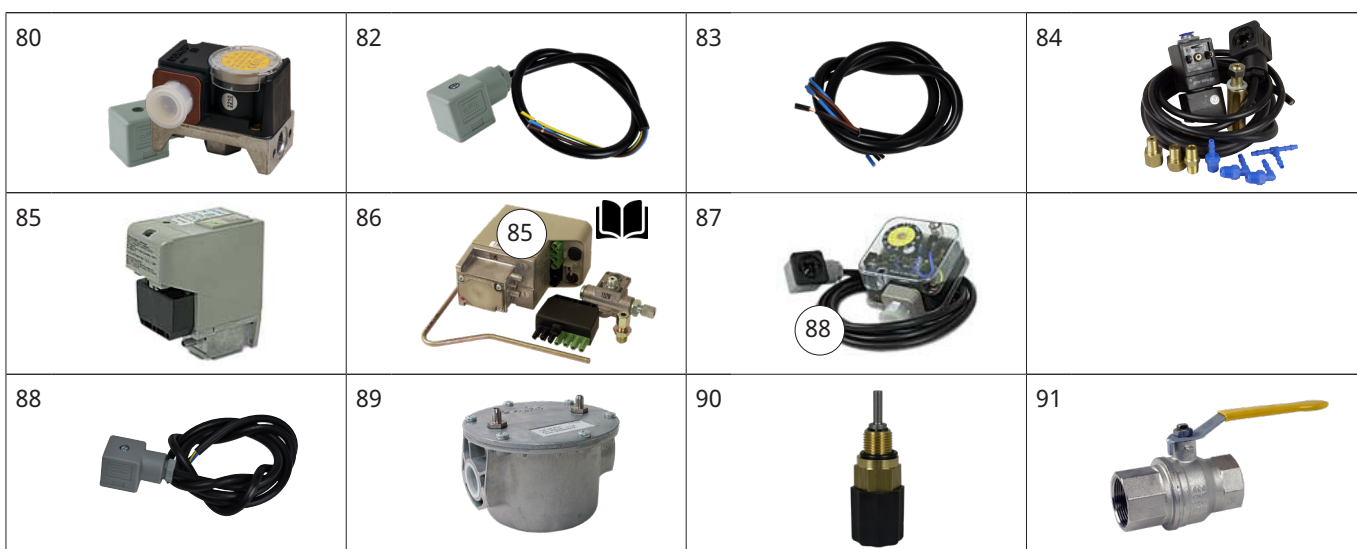

## 4. Gasventil - Gas Valve - Gasventil - Vanne de gaz - (MultiBloc)

Namn	Name	Name	Nom	Information	Artikel nr
92 Vinkelkoppling	Elbow	Winkelkupplung	Coude	1/8"	0011545201
93 Koppling rak	Coupling straight	Kupplung gerade	Raccord droit.	1/8"	0011545101
94 Adapter set GW Dungs	Adapter kit GW Dungs	Adapter Satz GW Dungs	Adapteur kit GW Dungs		0012127101
96 Bländare	Diaphragm	Blende	Diaphragme	10 mm	0011910201
96 Bländare	Diaphragm	Blende	Diaphragme	15 mm	0011910202
98 Impulsrör, metervara	Impulse tube, meter goods	Impulsrohr, meterware	Tube d'impulsions, merchanide de mètre	Ø 6.0x1.0 fz	0023107700

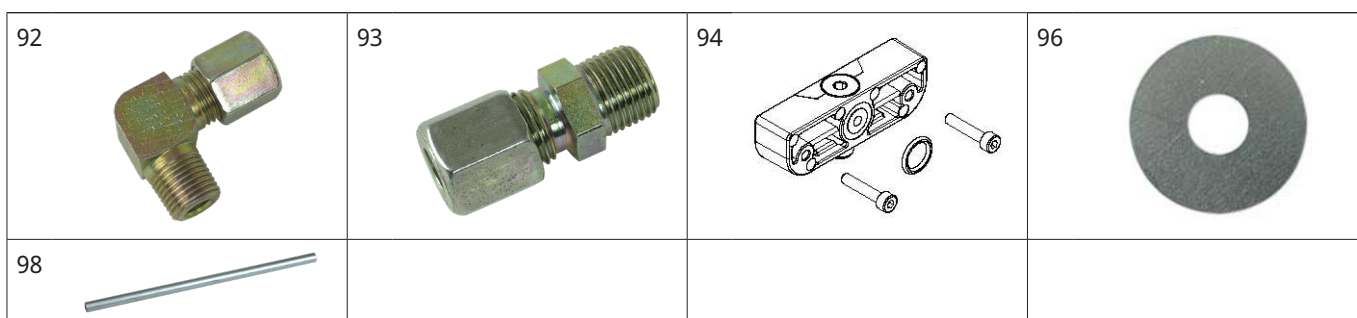

## 5. Elkomponenter - Electrical - Elektrische - Électriques

Namn	Name	Name	Nom	Information	Artikel nr
1 Reläbox	Control box	Steuergerät	Boite de relais	LFL 1.333E	0011463204
3 Reläbox	Control box	Steuergerät	Boite de relais	LME21.230C2E	0092070101
3 Reläbox	Control box	Steuergerät	Boite de relais	LME11.230C2E	0092070001
3 Reläbox	Control box	Steuergerät	Boite de relais	LME22.232C2E	0092070201
3 Reläbox	Control box	Steuergerät	Boite de relais	LME22.233	0092070301
3 Reläbox	Control box	Steuergerät	Boite de relais	LME21.550C2	0092070401
5 Styrautomat	Automatic control unit with UV & FR Flame Amplifiers	Automatisches Steuergerät	Module de commande automatique	FirEye BP230UVFR-S2	0012122501
5 Styrautomat	Automatic control unit with UV & FR Flame Amplifiers, Valve Proving Feature and Modbus interface	Automatisches Steuergerät	Module de commande automatique	FirEye BP230UVFR-S4, Modbus	0012122701
10 Reläsockel kompl.	Base, control box compl.	Unterteil, Steuergerät kompl.	Socle de raccordement compl.	LFL, FirEye	0011463300
12 Reläsockel kompl.	Base, control box compl.	Unterteil, Steuergerät kompl.	Socle de raccordement compl.	LGB, LMG, LME	0091559600
15 Kåpa, elpanel	Cover, electric panel	Abdeckung, Schalttafel	Capot, panneau électrique	LGB, LMG, LME	0011807721
17 Kåpa, elpanel	Cover, electric panel	Abdeckung, Schalttafel	Capot, panneau électrique	LFL, FirEye	0011807722
19 Täckbricka	Cover plate	Abdeckscheibe	Plaqu de recouvrement	LGB, LMG, LME	0011789211

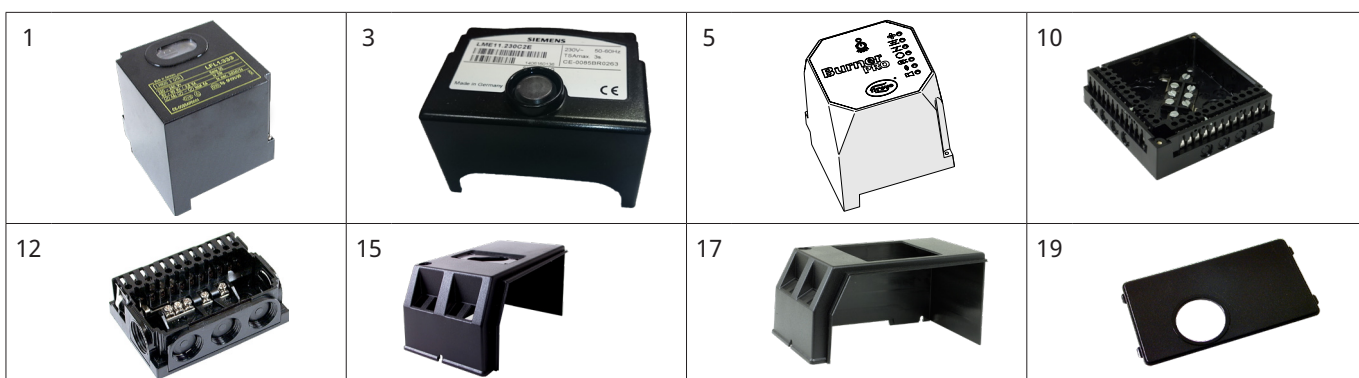

## 5. Elkomponenter - Electrical - Elektrische - Électriques

Namn	Name	Name	Nom	Information	Artikel nr
22 Signalförstärkare	Signal amplifier	Signalverstärker	Signal amplificateur	LGB/UV, AGQ1.2A27	0011898301
22 Signalförstärkare	Signal amplifier	Signalverstärker	Signal amplificateur	LME/UV, AGQ3.2A27	0011898304
25 Kontaktdon 4+7 pol kompl.	Plug-in contact 4+7-pole compl.	Steckerteil 4+7-polig kompl.	Fiche de prise de courant 4+7-polaire compl.		0011933301
26 7 pol, hane	7-pole, male	7-polig, Stecker	7-polaire, mâle		0011558500
27 7 pol, hona	7-pole, female	7-polig, Buchsenteil	7-polaire, femelle		0011558501
28 4 pol, hane, grön	4-pole, male, green	4-polig, Stecker, grön	4-polaire, mâle, vert		0011919701
29 4 pol, hona, grön	4-pole, female, green	4-polig, Buchsenteil, grön	4-polaire, femelle, vert		0011919801
31 Timräknare	Time meter	Betriebsstunden-zähler	Compteur horaire		0011767801
33 Indikeringslampa, grön	Indication lamp, green	Anzeigelampe, grön	Voyant lumineux, vert		0011721103
35 Strömbrytare	Switch	Schalter	Interrupteur	0-I	0012132201
36 Strömbrytare	Switch	Schalter	Interrupteur	I-II	0012132202
38 Omkopplare, manuell-automatisk	Switch, manuel-automatic	Umschalter, manuell-automatisch	Commutateurs, manuel-automatique		0012132203
38 Omkopplare, öka-minska	Switch, increase-decrease	Umschalter, erhöhen-reduzieren	Commutateurs, augmenter-réduire		0011784302
40 Kabel, pilottest	Cable, pilot test	Kabel, Pilotprüfung	Câble, essai pilote	170 mm	0012109802
42 Euro-kontakt, brännare extern reset (Tillbehör)	Plug-in contact, burner external reset (optional)	Eurostecker, Brenner Externe Rückstellung (optional)	Prise européenne, réarmement externe (en option), brûleur		0092062401



## 5. Elkomponenter - Electrical - Elektrische - Électriques



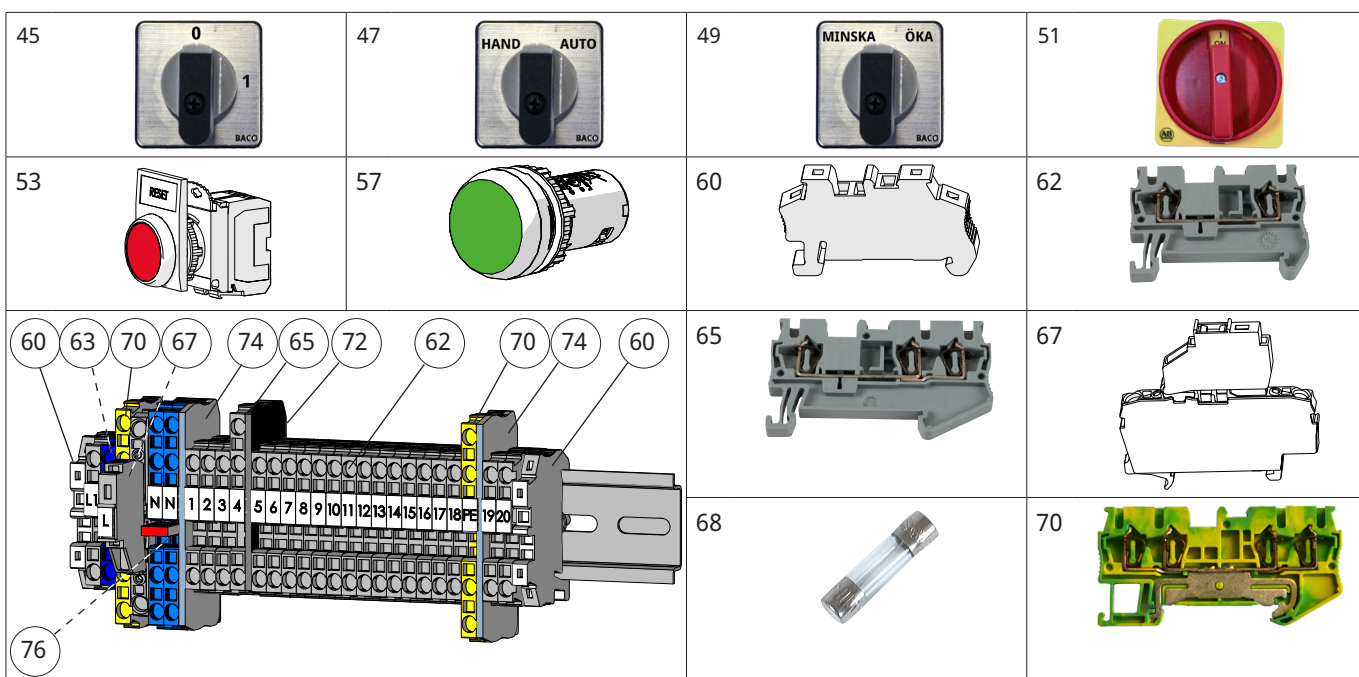



Namn	Name	Name	Nom	Information	Artikel nr
45 Strömbrytare, vrid	Change-over switch	Umschalter	Commutateur inverseur	0-I	0012114002
47 Omkopplare, manuell-automatisk	Switch, manuel-automatic	Umschalter, manuell-automatisch	Commutateurs, manuel-automatique		0012125601
49 Omkopplare, öka-minska	Switch, increase-decrease	Umschalter, erhöhen-reduzieren	Commutateurs, augmenter-réduire		0012125701
51 Strömbrytare säkerhetsvred	Switch Safety button	Schalttaste wechseln	Bouton de sécurité du commutateur		0012114112
53 Indikeringslampa utlöst relä/reset relä	Indicator light triggered relay/reset relay	Kontrollleuchte ausgelöstes Relais / Reset-Relais	Relais lumineux déclenché / relais de réinitialisation		0012127201
57 Indikeringslampa, grön	Indication lamp, green	Anzeigelampe, grün	Voyant lumineux, vert		0012126201
60 Ändstöd	End support	Support beenden	Fin du support		586938401
62 Plint	Terminal	Klemmen	Bornier	ST 2,5	913145401
63 Plint	Terminal	Klemmen	Bornier	ST 2,5 BU	913145402
65 Plint	Terminal	Klemmen	Bornier	ST 2,5 TWIN	913146401
65 Plint	Terminal	Klemmen	Bornier	ST 2,5 TWIN BU	913146402
65 Plint	Terminal	Klemmen	Bornier	ST 2,5 TWIN PE	913146403
67 Säkringsplint 5x20	Fuse terminal	Sicherungsklemme	Borne à fusible	5x20	0012103301
68 Säkring, fin	Fuse	Sicherung	Fusible	6.3A	0011333201
70 Plint	Terminal	Klemmen	Bornier	ST 2.5 QUATTRO PE	584359003
70 Plint	Terminal	Klemmen	Bornier	ST 2.5 QUATTRO BU	584359002





## 5. Elkomponenter - Electrical - Elektrische - Électriques

Namn	Name	Name	Nom	Information	Artikel nr
72 Ändstöd	End support	Support beenden	Fin du support	D-ST2,5 TWIN	913190402
74 Ändstöd	End support	Support beenden	Fin du support	2.5 QUATTRO	586936405
76 Bygel	Clamp	Bügel	Crampon	ST 2.5 2-pol	587052401
80 Kabel, flamövervakning, väggskåp-brännarskåp	Cable, flame monitoring, wall cabinet to burner cabinet	Kabel, Flammenüberwachung, Wandschrank zu Brennerschrank	Câble, surveillance des flammes, armoire murale à armoire de brûleur		0012115001
82 Kabelsats	Cable Kit	Kabelsatz	Jeu de câbles	J/K, BG 300	0012126901
87 UV-cell	UV-detector	UV-Detektor	Cellule UV	QRA 2	0091463401
89 Kabel, gastryckvakt max	Cable, gas pressure switch	Kabel, Gasdruckwächter	Câble, pessostat de gaz	4x0.75 L=1310	0011951118
89 Kabel, VPS	Cable, VPS	Kabel, VPS	Câble, VPS	4x0.75 L=1310	0012142014
89 Magnetventilkabel	Cable, solenoid valve	Kabel, Magnetventil	Câble, électrovanne	3X0,75 L=800, BU=1	0011951023
89 Magnetventilkabel	Cable, solenoid valve	Kabel, Magnetventil	Câble, électrovanne	4X0,75 L=530	0011951015
89 Magnetventilkabel	Cable, solenoid valve	Kabel, Magnetventil	Câble, électrovanne	3X0,75 L=530, BU=3	0011951018

72		74		76		80	
82		87		89			

## 6. Exteriör - Exterior - Exterieur - Extérieur

Namn	Name	Name	Nom	Information	Artikel nr
1 Lock	Cover	Deckel	Couvercle	BG 300	001189260005
3 Lock	Cover	Deckel	Couvercle	BG 400	001189750105
6 Packning, lock	Gasket, cover	Dichtung, Deckel	Joint, couvercle	BG 400	0011778301
8 Inspektionslock	Inspection cover	Deckel, Schauglas	Couvercle, viseur de flamme		0011708001
10 Inspektionsglas	Inspection glass	Schauglas	Voyant liquide		0011708101
12 Packning, inspektionsglas	Gasket, inspection glass	Dichtung, Inspektionsglas	Joint, verre d'inspection		0011778401
14 Lock, fotomotstånd	Cover, photoresistor	Deckel, Fotowiderstand	Couvercle, cellule photorésistante	BG 300	0011173101
16 Lock, fotomotstånd, avklippt	Cover, photoresistor, cut off	Deckel, Fotowiderstand, abschneiden	Couvercle, cellule photorésistante, couper	BG 300	0011173106
18 Täckplåt	Covering plate	Deckplatte	Plaque de recouvrement	BG 300	0011739101
20 Täckplåt	Covering plate	Deckplatte	Plaque de recouvrement	BG 400	0011788101
22 Kabelskydd	Cable protection	Kabelschutz	Protection de câble		0011718503
24 Plugg med nippel	Covering plug with nipple	Stopfe mit Nippel	Tampon, avec raccord	32 mm. BG 300	0011920912
24 Plugg med nippel	Covering plug with nipple	Stopfe mit Nippel	Tampon, avec raccord	54 mm. BG 400	0011920911

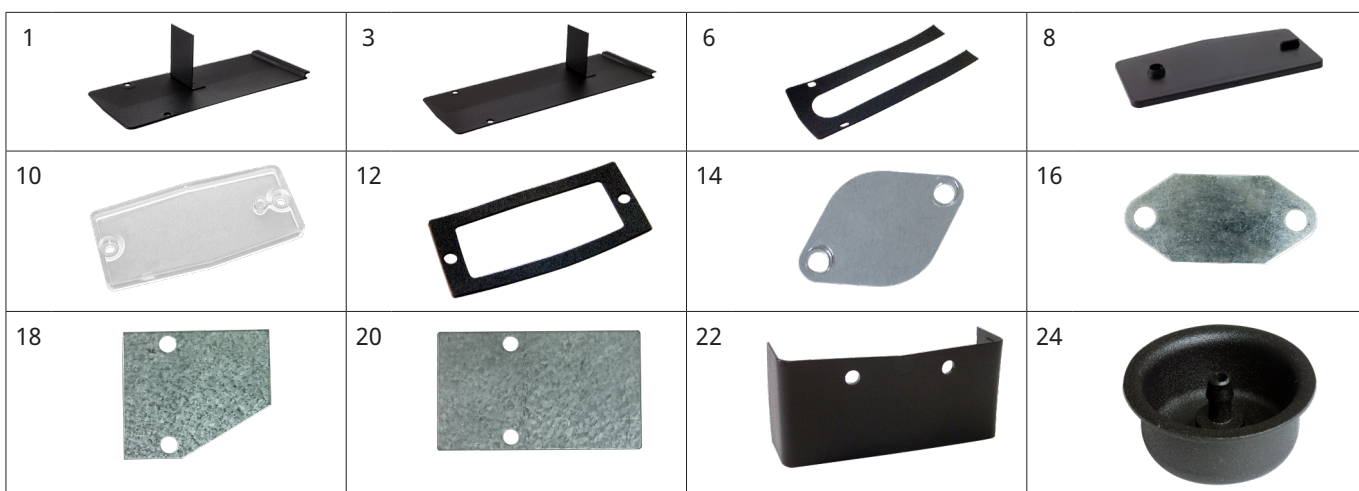

## 6. Exteriör - Exterior - Exterieur - Extérieur

Namn	Name	Name	Nom	Information	Artikel nr
27 Anslutningsfläns kompl.	Fixing flange compl.	Anschlussflansch kompl.	Bride de fixation compl.	BG 300	0011752201
27 Anslutningsfläns kompl.	Fixing flange compl.	Anschlussflansch kompl.	Bride de fixation compl.	BG 400	0011752203
29 Packning, fläns	Gasket, fixing flange	Dichtung, Anschlussflansch	Joint, bride de fixation	194 x 194 mm, BG 300, BG 400	0011729701
30 O-ring	O-ring	O-ring	Joint torique	134,5X3,0	0011316829
31 Ändavslutning	Covering plug	Endstück	Bouchon de protection		0011810301
33 Ratt	Knob	Knopf	Bouton		001172150105

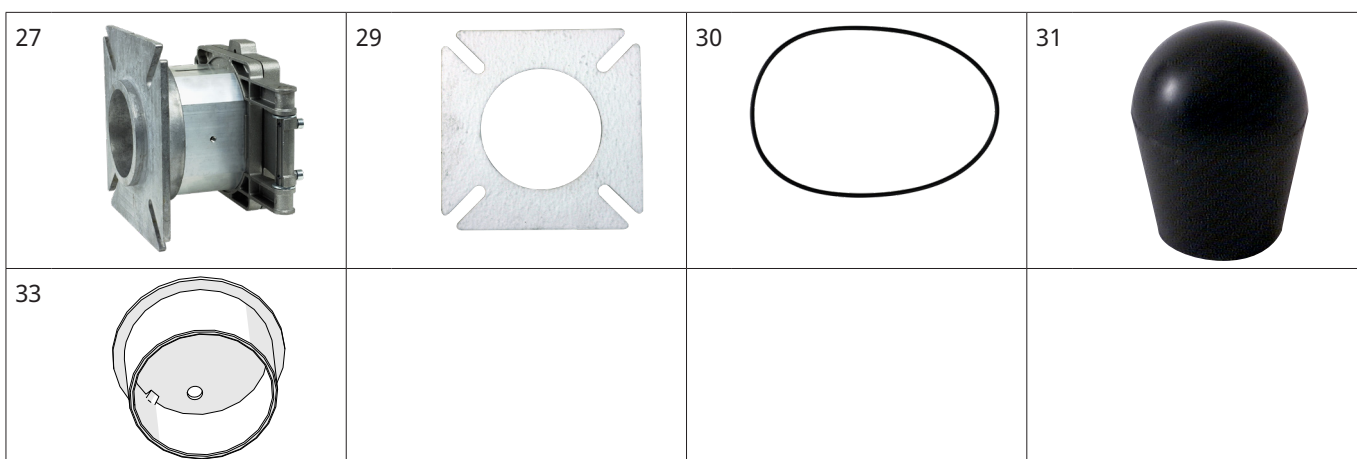

## 7. Luftreglering - Air control - Luftsteuerung - Régularisation à air

Namn	Name	Name	Nom	Information	Artikel nr
1 Luftreglering	Air control	Luftsteuerung	Régularisation à air	BG 300	0091827501
5 Spjällmotor, 2-steg	Damper motor, 2-stage	Klappenmotor, 2-stufig	Moteur de volet, 2 allures	LFL, SQN75.294.A21B	0011942303
5 Spjällmotor, modulerande	Damper motor, modulationg	Klappenmotor, modullerend	Moteur de volet, modullant	LFL, SQN75.664A21B	0011942305
5 Spjällmotor, 2-steg	Damper motor, 2-stage	Klappenmotor, 2-stufig	Moteur de volet, 2 allures	LMG, SQN75.254.A21B	0011942307
5 Spjällmotor, modulerande	Damper motor, modulationg	Klappenmotor, modullerend	Moteur de volet, modullant	LMG, SQN75.624.A21B	0011942309
7 Kabel, spjällmotor	Cable, damper motor	Kabel, Klappenmotor	Câble, mMoteur de volet	8x0.5 L=850	0011935617
9 Slangnippel	Hose nipple	Schlauchnippel	Raccord de tuyau flexible	V4x1/8	0011575301
11 Slangnippel, luftvakt, rak	Hose nipple, air switch, straight	Schlauchnippel, Luftwächter, gerade	Raccord de tuyau flexible, pressostat d'air, droite	V4x1/8	0011562101
13 Nippel	Nipple	Nippel	Raccord		0011542301



## 8. Övrigt - Sundries - Verschiedenes - Divers

Namn	Name	Name	Nom	Information	Artikel nr
1 Effektregulator	Power control	Leistungsregler	Régulateur de puissance	R316 T, PT 100	0012052601
1 Effektregulator, tryck	Power control, pressure	Leistungsregler, druck	Régulateur de puissance, pression	R316 T, 0-10V	0012052602
1 Effektregulator	Power control	Leistungsregler	Régulateur de puissance	R316 M, PT 100	0012052701
1 Effektregulator, tryck	Power control, pressure	Leistungsregler, druck	Régulateur de puissance, pression	R316 M, 0-10V	0012052702
3 Transformator	Transformer	Transformator	Transformateur	HDR-15-24 220 VAC/24 VDC	0012133901
5 Givare	Sensor	Fühler	Sonde	PT 100	0011581902
8 Jumo tryckgivare	Jumo pressure transmitter	Jumo Drucktransmitter	Jumo transmetteur de pression	0-1 bar	0011581905
8 Jumo tryckgivare	Jumo pressure transmitter	Jumo Drucktransmitter	Jumo transmetteur de pression	0-10 bar	0011581906
8 Jumo tryckgivare	Jumo pressure transmitter	Jumo Drucktransmitter	Jumo transmetteur de pression	0-16 bar	0011581907
10 Jumo termoelement	Jumo thermocouple	Jumo Thermoelement	Jumo thermocouple	-200 - 1500	0011581910
12 Jumo klämförskruvning termoelement	Jumo compression fitting thermocouple	Jumo, Klemmverschraubung für Thermoelemente	Jumo raccord à vis de serrage pour thermocouples		0011581911
15 Effektregulator, kapslad	Power regulator in device box	Leistungsregler im Gerätekasten	Régulateur de puissance dans la boîte de l'appareil	R316 T, PT 100	0012134901
15 Effektregulator, kapslad, tryck	Power regulator in device box, pressure	Leistungsregler im Gerätekasten, druck	Régulateur de puissance dans la boîte de l'appareil, pression	R316 T, 0-10V	0012134902
15 Effektregulator, kapslad	Power regulator in device box	Leistungsregler im Gerätekasten	Régulateur de puissance dans la boîte de l'appareil	R316 M, PT 100	0012134903
15 Effektregulator, kapslad, tryck	Power regulator in device box, pressure	Leistungsregler im Gerätekasten, druck	Régulateur de puissance dans la boîte de l'appareil, pression	R316 M, 0-10V	0012134904

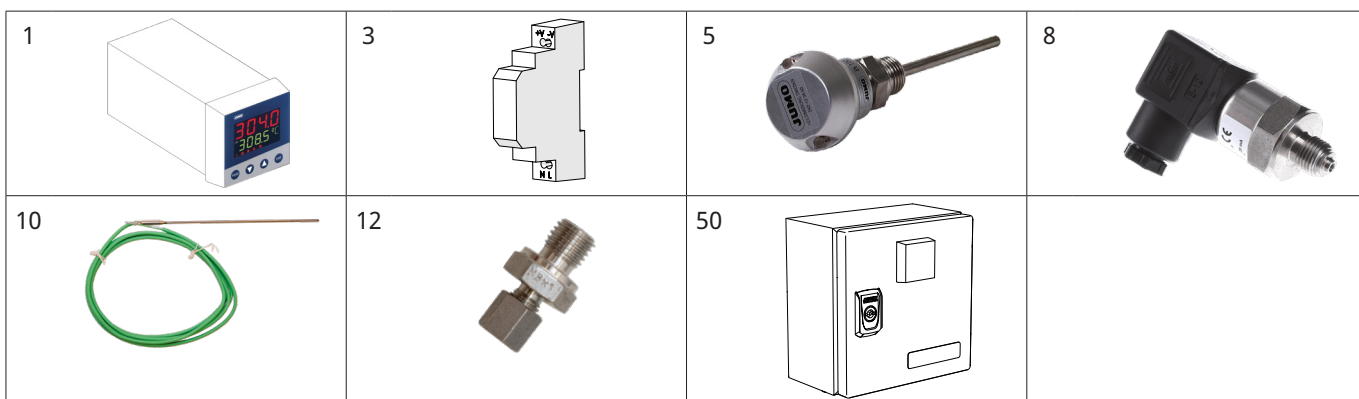







CTC AB Box 309 SE-341 26 Ljungby

info@bentone.se +46 372 88 000

[www.bentone.se](http://www.bentone.se)