



## **Bentone BG 700, BG 800**

Reservdelar och tillbehör

Spare Parts and Accessories

Ersatzteile und Zubehör

Pièces détachées et accessoires



MADE IN SWEDEN

# Innehåll - Index - Inhalt - Sommaire

Produktmodeller - Product Models - Modelle - Modèles _____	3
1. Förbränningsdon-Cumbustion device	
-Verbrennungsvorrichtung-Ensemble de combustion_	13
2. Motor - Motor - Motor - Moteur _____	16
3. Gasventil - Gas Valve - Gasventil - Vanne de gaz - (MultiBloc)	17
4. Elkomponenter - Electrical components	
- Elektrische Komponenten - Composants électriques_	23
5. Luftreglering - Air control - Luftsteuerung	
- Régularisation à air _____	27
6. Fläkthus - Fan housing - Lüftergehäuse	
- Carter de ventilateur _____	28
7. Tillbehör - Accessories - Zubehör - Accessoires _____	29

## Produktmodeller - Product Models - Modelle - Modèles

EAN	rsk no	art no	
7333077084943		800004980615	BG700i M L363 LMV 415 IP4
7333077090579		800005580615	BG700i M L363 LMV 420 IP40
7333077093792		800005780602	BG700 M L363 BPS2 415VP
7333077093808		800005880902	BG700 M L363 BPS2 420VP 60HZ
7333077093815		800005980601	BG700 M L363 BPS2 420VP
7333077093822		800006080604	BG700 M L363 BPS2 420VP RT
7333077093839		800006180611	BG700-2 L363 BPS2 525VP UV
7333077093846		800006280605	BG700 M L363 BPS2 425VP
7333077093853		800006380601	BG700 M L663 BPS2 420VP
7333077093860		800006480901	BG700 M L363 BPS2 415VP 60HZ
7333077093877		800006580602	BG700 M L363 BPS2 415VP 60HZ
7333077083083		810003281610	BG800i M L396 LMV 4.80 UV IP40
7333077085223		810004081609	BG800i M L396 LMV 420 IP40
7333077093884		810004481601	BG800 M L396 BPS2 425VP
7333077093891		810004581601	BG800 M L696 BPS2 425VP
7333077093907		810004681601	BG800 M L396 BPS2 420VP
7333077093914		810004781603	BG800 M L396 BPS2 425VP RT
7333077093921		810004881901	BG800 M L396 BPS2 420VP 60HZ

800004980615	BG700i M L363 LMV 415 IP4	1																		
800005580615	BG700i M L363 LMV 420 IP40		1																	
800005780602	BG700 M L363 BPS2 415VP			1																
800005880902	BG700 M L363 BPS2 420VP 60HZ				1															
800005980601	BG700 M L363 BPS2 420VP					1														
800006080604	BG700 M L363 BPS2 420VP RT						1													
800006180611	BG700-2 L363 BPS2 525VP UV							1												
800006280605	BG700 M L363 BPS2 425VP								1											
800006380601	BG700 M L663 BPS2 420VP									1										
800006480901	BG700 M L363 BPS2 415VP 60HZ										1									
800006580602	BG700 M L363 BPS2 415VP 60HZ											1								
810003281610	BG800i M L396 LMV 4.80 UV IP40												1							
810004081609	BG800i M L396 LMV 420 IP40													1						
810004481601	BG800 M L396 BPS2 425VP														1					
810004581601	BG800 M L696 BPS2 425VP															1				
810004681601	BG800 M L396 BPS2 420VP																1			
810004781603	BG800 M L396 BPS2 425VP RT																	1		
810004881901	BG800 M L396 BPS2 420VP 60HZ																			1

**Förbränningsdon-Cumbustion device-Verbrennungsvorrichtung-Ensemble de combustion**

11919401	Flame tube	BG 700, L=363 mm	1	1	1	1	1	1	1	1	1	1	1	1	1	1	1	1	1	1
11919402	Flame tube	BG 700, L=663 mm										1								
11919501	Flame tube	BG 800, L=396 mm												1	1	1		1	1	1
11919502	Flame tube	BG 800, L=696 mm															1			
11950301	Nozzle assembly	BG 700, L=363 mm	1	1	1	1	1	1	1	1	1	1	1	1	1	1	1	1	1	1
11950302	Nozzle assembly	BG 700, L=663 mm										1								
11950201	Nozzle assembly	BG 800, L=396 mm												1	1	1		1	1	1
11950202	Nozzle assembly	BG 800, L=696 mm															1			
11913401	Tube	BG 700, L=363 mm	1	1	1	1	1	1	1	1	1	1	1	1	1	1	1	1	1	1
11913402	Tube	BG 700, L=663 mm										1								
11913701	Tube	BG 800, L=396 mm												1	1	1		1	1	1
11913702	Tube	BG 800, L=696 mm															1			
91865501	Ignition electrode		1	1	1	1	1	1	1	1	1	1	1	1	1	1	1	1	1	1
11534602	Ignition electrode	UV							1					1						
91837301	Ionization electrode		1	1	1	1	1	1	1	1	1	1	1	1	1	1	1	1	1	1
11009903	Bracket		1	1	1	1	1	1	1	1	1	1	1	1	1	1	1	1	1	1
11316843	O-ring	81,92X5,34	1	1											1					
11473524	Brake plate, even serial number 2495721	BG 700	1	1	1	1	1	1	1	1	1	1	1	1	1	1	1	1	1	1
92127933	Brake plate, from the serial number 2495722	BG 700	1	1	1	1	1	1	1	1	1	1	1	1	1	1	1	1	1	1
12127932	Brake plate, for burners before 2007	BG 800													1	1	1	1	1	1
92127925	Brake plate, for burners after 2007	BG 800													1	1	1	1	1	1
12026304	Ignition Cable Kit		1	1	1	1	1	1	1	1	1	1	1	1	1	1	1	1	1	1
12026314	Ignition Cable Kit		1	1	1	1	1	1	1	1	1	1	1	1	1	1	1	1	1	1
12074815	Ignition/Ionisation cable	150 mm.	1	1	1	1	1	1	1	1	1	1	1	1	1	1	1	1	1	1
12074825	Ignition/Ionisation cable	250 mm.	1	1	1	1	1	1	1	1	1	1	1	1	1	1	1	1	1	1
12074855	Ignition/Ionisation cable	550 mm.	1	1	1	1	1	1	1	1	1	1	1	1	1	1	1	1	1	1

800004980615	BG700i M L363 LMV 415 IP4		1																
800005580615	BG700i M L363 LMV 420 IP40			1															
800005780602	BG700 M L363 BPS2 415VP				1														
800005880902	BG700 M L363 BPS2 420VP 60HZ					1													
800005980601	BG700 M L363 BPS2 420VP						1												
800006080604	BG700 M L363 BPS2 420VP RT							1											
800006180611	BG700-2 L363 BPS2 525VP UV								1										
800006280605	BG700 M L363 BPS2 425VP									1									
800006380601	BG700 M L663 BPS2 420VP										1								
800006480901	BG700 M L363 BPS2 415VP 60HZ											1							
800006580602	BG700 M L363 BPS2 415VP 60HZ												1						
810003281610	BG800i M L396 LMV 4.80 UV IP40													1					
810004081609	BG800i M L396 LMV 420 IP40														1				
810004481601	BG800 M L396 BPS2 425VP															1			
810004581601	BG800 M L696 BPS2 425VP																1		
810004681601	BG800 M L396 BPS2 420VP																	1	
810004781603	BG800 M L396 BPS2 425VP RT																		1
810004881901	BG800 M L396 BPS2 420VP 60HZ																		1
12074925	Ignitioncable	250 mm.	1	1	1	1	1	1	1	1	1	1	1	1	1	1	1	1	1
12074945	Ignitioncable	450 mm.	1	1	1	1	1	1	1	1	1	1	1	1	1	1	1	1	1
12074950	Ignitioncable	500 mm.	1	1	1	1	1	1	1	1	1	1	1	1	1	1	1	1	1
12074955	Ignitioncable	550 mm.	1	1	1	1	1	1	1	1	1	1	1	1	1	1	1	1	1
11924201	Insulator		1	1	1	1	1	1	1	1	1	1	1	1	1	1	1	1	1
12118150	Ionisation cable, male, female	500 mm.	1	1	1	1	1	1	1	1	1	1	1	1	1	1	1	1	1
11865804	Ionisation cable, female	400 mm.	1	1	1	1	1	1	1	1	1	1	1	1	1	1	1	1	1
12026302	Ignitioncable	250/ 500mm.	1	1	1	1	1	1	1	1	1	1	1	1	1	1	1	1	1

**Motor - Motor - Motor - Moteur**

12115401	Motor	BG 700, 3.0/3.6kW 50Hz 3F, IP55, 230/400V	1	1	1		1	1	1	1	1								
12115501	Motor	BG 700, BG 800, 3.0/3.6kW 50/60Hz 3F, IP55, 230/400V					1					1		1	1	1	1	1	1
11277607	Fan wheel	BG 700	1	1	1	1	1	1	1	1	1	1							
11277622	Fan wheel	BG 800											1	1	1	1	1	1	1
1190430105	Flange, motor	BG 700, BG 800	1	1	1	1	1	1	1	1	1	1	1	1	1	1	1	1	1
11914401	Conical shield plate	BG 700	1	1	1	1	1	1	1	1	1								
11906201	Conical shield plate	BG 800											1	1	1	1	1	1	1
11944903	Cable motor	4x1.5 3F, BG 700	1	1	1	1	1	1	1	1	1	1							
11944902	Cable motor	4x2.5 3F, BG 800												1	1	1	1	1	1



800004980615	BG700i M L363 LMV 415 IP4		1																	
800005580615	BG700i M L363 LMV 420 IP40			1																
800005780602	BG700 M L363 BPS2 415VP				1															
800005880902	BG700 M L363 BPS2 420VP 60HZ					1														
800005980601	BG700 M L363 BPS2 420VP						1													
800006080604	BG700 M L363 BPS2 420VP RT							1												
800006180611	BG700-2 L363 BPS2 525VP UV								1											
800006280605	BG700 M L363 BPS2 425VP									1										
800006380601	BG700 M L663 BPS2 420VP										1									
800006480901	BG700 M L363 BPS2 415VP 60HZ											1								
800006580602	BG700 M L363 BPS2 415VP 60HZ												1							
810003281610	BG800i M L396 LMV 4.80 UV IP40													1						
810004081609	BG800i M L396 LMV 420 IP40														1					
810004481601	BG800 M L396 BPS2 425VP															1				
810004581601	BG800 M L696 BPS2 425VP																1			
810004681601	BG800 M L396 BPS2 420VP																	1		
810004781603	BG800 M L396 BPS2 425VP RT																		1	
810004881901	BG800 M L396 BPS2 420VP 60HZ																			1
11916511	Filter set	410/412																		
11916601	Filter set	415/420	1	1	1	1	1	1	1	1	1	1	1	1	1	1	1	1	1	1
11861701	Valve, leak tester	VPS 504SO2			1	1	1	1	1	1	1	1	1	1	1	1	1	1	1	1
11531907	Pressure switch	LGW 50A2 2,5-50 MBAR	1	1	1	1	1	1	1	1	1	1	1	1	1	1	1	1	1	1
91531929	Pressure switch	GW 50A6																		
11531926	Pressure switch	GW 50A5, 5-50 MBAR																		
11531927	Pressure switch	GW 150A5, 10-150 MBAR						1	1						1	1			1	
12079704	Pressure switch gas	QPL15.150											1							
11899201	Flange	1 1/2", 415/420	1		1							1	1							
11899202	Flange	2", 415/420		1		1	1	1			1				1				1	1
11899302	Flange	2", 425						1	1						1	1				
11566713	Flange	1 1/4", 410/412																		
11566718	Flange	1 1/4", 410/412																		
11968402	Impulse flange	VEF 412																		
11968403	Impulse flange	VEF 415			1							1								
11968404	Impulse flange	VEF 420				1	1	1			1									
11968405	Impulse flange	VEF 425							1						1	1			1	
11542701	Test nipple	R1/8"xØ8	1	1	1	1	1	1	1	1	1	1	1	1	1	1	1	1	1	1
12074501	Test nipple	R1/8"xØ8	1	1	1	1	1	1	1	1	1	1	1	1	1	1	1	1	1	1
12078231	Impulse tube, furnace																			
12078232	Impulse tube, fan																			
12078233	Impulse tube, gas																			
23107700	Impulse tube, by the meter	Ø6,0x1,0 fz																		
11545201	Elbow	1/8"	1	1	1	1	1	1	1	1	1	1	1	1	1	1	1	1	1	1
11545101	Coupling straight	1/8"	1	1	1	1	1	1	1	1	1	1	1	1	1	1	1	1	1	1
11469301	Nipple	R1/8" x G1/8"																		
11463703	Nipple	1 1/2" x 1 1/2"																		





800004980615	BG700i M L363 LMV 415 IP4	1																		
800005580615	BG700i M L363 LMV 420 IP40		1																	
800005780602	BG700 M L363 BPS2 415VP			1																
800005880902	BG700 M L363 BPS2 420VP 60HZ				1															
800005980601	BG700 M L363 BPS2 420VP					1														
800006080604	BG700 M L363 BPS2 420VP RT						1													
800006180611	BG700-2 L363 BPS2 525VP UV							1												
800006280605	BG700 M L363 BPS2 425VP								1											
800006380601	BG700 M L663 BPS2 420VP									1										
800006480901	BG700 M L363 BPS2 415VP 60HZ										1									
800006580602	BG700 M L363 BPS2 415VP 60HZ											1								
810003281610	BG800i M L396 LMV 4.80 UV IP40												1							
810004081609	BG800i M L396 LMV 420 IP40													1						
810004481601	BG800 M L396 BPS2 425VP														1					
810004581601	BG800 M L696 BPS2 425VP															1				
810004681601	BG800 M L396 BPS2 420VP																1			
810004781603	BG800 M L396 BPS2 425VP RT																	1		
810004881901	BG800 M L396 BPS2 420VP 60HZ																		1	

**Elkomponenter - Electrical - Elektrische - Électriques**

11463204	Control box	LFL 1.333E																		
12122501	Automatic control unit	BP230UVFR-S2			1	1	1	1	1	1	1	1			1	1	1	1	1	1
11463300	Base, control box		1	1	1	1	1	1	1	1	1	1	1	1	1	1	1	1	1	1
12122901	Flame detector	UV 5-2						1					1							
12126601	Flange, flame detector	UV 5-2						1					1							
12143101	Contactor	LC1D09P7	1	1	1		1	1	1	1	1	1								
12143102	Contactor	LC1D18P7				1						1		1	1	1	1	1	1	1
12143103	Contactor	LC1D25P7																		
12143205	Thermal overload protection	5.5-8.0 A	1	1	1			1	1	1	1	1								
12143208	Thermal overload protection	9.0-13.0 A				1						1		1	1	1	1	1	1	1
12143212	Thermal overload protection	16.0-24.0 A																		
11333201	Holder, fuse																			
11811803	Fuse	6,3A			1	1	1	1	1	1	1	1			1	1	1	1	1	1
11852303	Transformer compl.	Fida			1	1	1	1		1	1	1	1		1	1	1	1	1	1
11804702	Cable, transformer	FIDA L=700mm	1	1	1	1	1	1	1	1	1	1	1	1	1	1	1	1	1	1
92043202	Transformer compl.	Fida	1	1										1						
11804701	Cable, transformer	FIDA L=700mm	1	1	1	1	1	1	1	1	1	1	1	1	1	1	1	1	1	1
11804601	Transformer	Fida						1												
12043201	Transformer	Fida											1							
12132201	Switch	0-I	1	1	1	1	1	1	1	1	1	1	1	1	1	1	1	1	1	1
12132202	Switch	I-II	1	1	1	1	1	1	1	1	1	1	1	1	1	1	1	1	1	1
12132203	Switch, manuel-automatic		1	1	1	1	1	1	1	1	1	1	1	1	1	1	1	1	1	1
11784302	Switch, increase-decrease		1	1	1	1	1	1	1	1	1	1	1	1	1	1	1	1	1	1
11721103	Indication lamp, green		1	1	1	1	1	1	1	1	1	1	1	1	1	1	1	1	1	1
11948601	Plug-in contact 7+4+5+4-pole compl.	BG 700-2						1					1							
11948612	Plug-in contact 7+4+5+4-pole compl.	BG 700M	1	1	1	1	1	1		1	1	1								

800004980615	BG700i M L363 LMV 415 IP4		1																	
800005580615	BG700i M L363 LMV 420 IP40			1																
800005780602	BG700 M L363 BPS2 415VP				1															
800005880902	BG700 M L363 BPS2 420VP 60HZ					1														
800005980601	BG700 M L363 BPS2 420VP						1													
800006080604	BG700 M L363 BPS2 420VP RT							1												
800006180611	BG700-2 L363 BPS2 525VP UV								1											
800006280605	BG700 M L363 BPS2 425VP									1										
800006380601	BG700 M L663 BPS2 420VP										1									
800006480901	BG700 M L363 BPS2 415VP 60HZ											1								
800006580602	BG700 M L363 BPS2 415VP 60HZ												1							
810003281610	BG800i M L396 LMV 4.80 UV IP40													1						
810004081609	BG800i M L396 LMV 420 IP40														1					
810004481601	BG800 M L396 BPS2 425VP															1				
810004581601	BG800 M L696 BPS2 425VP																1			
810004681601	BG800 M L396 BPS2 420VP																	1		
810004781603	BG800 M L396 BPS2 425VP RT																		1	
810004881901	BG800 M L396 BPS2 420VP 60HZ																			1
11948613	Plug-in contact 7+4+5+4-pole compl.	BG 800M												1	1	1	1	1	1	1
11920001	5-pole, female		1	1	1	1	1	1	1	1	1	1	1	1	1	1	1	1	1	1
11919901	5-pole, male		1	1	1	1	1	1	1	1	1	1	1	1	1	1	1	1	1	1
91558501	7-pole, female	BG 700	1	1	1	1	1	1	1	1	1	1								
11558603	7-pole, female	BG 800											1	1	1	1	1	1	1	1
11558500	7-pole, male		1	1	1	1	1	1	1	1	1	1	1	1	1	1	1	1	1	1
11919801	4-pole, female		1	1	1	1	1	1	1	1	1	1	1	1	1	1	1	1	1	1
11919701	4-pole, male		1	1	1	1	1	1	1	1	1	1	1	1	1	1	1	1	1	1
11421616	Plug-in contact, solenoid valve, female V0		1	1	1	1	1	1	1	1	1	1	1	1	1	1	1	1	1	1
11421624	Plug-in contact, gas guard V0 female		1	1	1	1	1	1	1	1	1	1	1	1	1	1	1	1	1	1
12101101	Display	AZL.23	1	1									1	1						
12106301	Cable, display	AZL.23, L= 186,4 mm	1	1									1	1						
12101004	Automatic control unit	LMV37 ver. 4	1	1									1	1						
12106200	Plug-in-contact set	AGG3.132, X3-X75, LMV	1	1									1	1						
12106001	Cable, solenoid valve	Hirshmann	1	1									1	1						
12104401	Cable, air pressure switch		1	1									1	1						

**Luftreglering - Air control - Luftsteuerung - Régularisation à air**

11942310	Damper motor, 2-stage	BG 700, LMG, SQN75.254.A21B								1										
11942305	Damper motor, modulationg	SQN75.664A21B			1	1	1	1		1	1	1				1	1	1	1	1
12101601	Damper motor, modulationg	BG 700i M, SQM 33	1	1																
11946301	Air damper compl.		1	1	1	1	1	1	1	1	1	1	1	1	1	1	1	1	1	1
11542301	Nipple		1	1	1	1	1	1	1	1	1	1	1	1	1	1	1	1	1	1
11947001	Slewing bracket compl.				1	1	1	1		1	1	1				1	1	1	1	1
11575301	Nipple, flexible pipe	V4*1/8	1	1										1						

800004980615	BG700i M L363 LMV 415 IP4	1																	
800005580615	BG700i M L363 LMV 420 IP40		1																
800005780602	BG700 M L363 BPS2 415VP			1															
800005880902	BG700 M L363 BPS2 420VP 60HZ				1														
800005980601	BG700 M L363 BPS2 420VP					1													
800006080604	BG700 M L363 BPS2 420VP RT						1												
800006180611	BG700-2 L363 BPS2 525VP UV							1											
800006280605	BG700 M L363 BPS2 425VP								1										
800006380601	BG700 M L663 BPS2 420VP									1									
800006480901	BG700 M L363 BPS2 415VP 60HZ										1								
800006580602	BG700 M L363 BPS2 415VP 60HZ											1							
810003281610	BG800i M L396 LMV 4.80 UV IP40												1						
810004081609	BG800i M L396 LMV 420 IP40													1					
810004481601	BG800 M L396 BPS2 425VP														1				
810004581601	BG800 M L696 BPS2 425VP															1			
810004681601	BG800 M L396 BPS2 420VP																1		
810004781603	BG800 M L396 BPS2 425VP RT																	1	
810004881901	BG800 M L396 BPS2 420VP 60HZ																		1

**Fläkthuset - Fan housing - Lüftergehäuse - Carter de ventilateur**

91914601	Fixing flange compl.	1	1	1	1	1	1	1	1	1	1	1	1	1	1	1	1	1	1
11914601	Fixing flange	1	1	1	1	1	1	1	1	1	1	1	1	1	1	1	1	1	1
1191420105	Guide	1	1	1	1	1	1	1	1	1	1	1	1	1	1	1	1	1	1
11922601	Gasket, fan housing/flange, metal	1	1	1	1	1	1	1	1	1	1	1	1	1	1	1	1	1	1
12134301	Gasket, fan housing/flange	1	1	1	1	1	1	1	1	1	1	1	1	1	1	1	1	1	1
11278807	Gasket	1	1	1	1	1	1	1	1	1	1	1	1	1	1	1	1	1	1
1191500005	Cover	1	1	1	1	1	1	1	1	1	1	1	1	1	1	1	1	1	1
11915101	Gasket, cover	1	1	1	1	1	1	1	1	1	1	1	1	1	1	1	1	1	1
11904801	Protective grating	1	1	1	1	1	1	1	1	1	1	1	1	1	1	1	1	1	1
1190660105	Cover, inspection glass	1	1	1	1	1	1	1	1	1	1	1	1	1	1	1	1	1	1
11708001	Inspection cover	1	1	1	1	1	1	1	1	1	1	1	1	1	1	1	1	1	1
11801801	Locking ring	1	1	1	1	1	1	1	1	1	1	1	1	1	1	1	1	1	1
11808801	Inspection glass	1	1	1	1	1	1	1	1	1	1	1	1	1	1	1	1	1	1
11795301	Gasket, inspection glass	1	1	1	1	1	1	1	1	1	1	1	1	1	1	1	1	1	1
11173101	Cover, photoresistor																		

800004980615	BG700i M L363 LMV 415 IP4	1																	
800005580615	BG700i M L363 LMV 420 IP40		1																
800005780602	BG700 M L363 BPS2 415VP			1															
800005880902	BG700 M L363 BPS2 420VP 60HZ				1														
800005980601	BG700 M L363 BPS2 420VP					1													
800006080604	BG700 M L363 BPS2 420VP RT						1												
800006180611	BG700-2 L363 BPS2 525VP UV							1											
800006280605	BG700 M L363 BPS2 425VP								1										
800006380601	BG700 M L663 BPS2 420VP									1									
800006480901	BG700 M L363 BPS2 415VP 60HZ										1								
800006580602	BG700 M L363 BPS2 415VP 60HZ											1							
810003281610	BG800i M L396 LMV 4.80 UV IP40												1						
810004081609	BG800i M L396 LMV 420 IP40													1					
810004481601	BG800 M L396 BPS2 425VP														1				
810004581601	BG800 M L696 BPS2 425VP															1			
810004681601	BG800 M L396 BPS2 420VP																1		
810004781603	BG800 M L396 BPS2 425VP RT																	1	
810004881901	BG800 M L396 BPS2 420VP 60HZ																		1

**Tillbehör - Accessories - Zubehör - Accessoires**

11923001	Solenoid Valve Kit, continuous fan	1	1	1	1	1	1	1	1	1	1	1	1	1	1	1	1	1	1
11950701	Power switch	ÜB50/A2																	
92062401	Plug-in contact, burner external reset																		
92101901	Modbus unit	1	1	1	1	1	1	1	1	1	1	1	1	1	1	1	1	1	1
12052601	Power control	R316 T, PT 100		1	1	1	1	1	1	1	1	1	1	1	1	1	1	1	1
12052602	Power control, pressure	R316 T, 0-10V		1	1	1	1	1	1	1	1	1	1	1	1	1	1	1	1
12052701	Power control	R316 M, PT 100		1	1	1	1	1	1	1	1	1	1	1	1	1	1	1	1
12052702	Power control, pressure	R316 M, 0-10V		1	1	1	1	1	1	1	1	1	1	1	1	1	1	1	1
12133901	Transformer	HDR-15-24 220 VAC/24 VDC		1	1	1	1	1	1	1	1	1	1	1	1	1	1	1	1
11581902	Sensor	PT 100		1	1	1	1	1	1	1	1	1	1	1	1	1	1	1	1
11581905	Jumo pressure transmitter	0-1 bar		1	1	1	1	1	1	1	1	1	1	1	1	1	1	1	1
11581906	Jumo pressure transmitter	0-10 bar		1	1	1	1	1	1	1	1	1	1	1	1	1	1	1	1
11581907	Jumo pressure transmitter	0-16 bar		1	1	1	1	1	1	1	1	1	1	1	1	1	1	1	1
11581910	Jumo thermocouple	-200 - 1500		1	1	1	1	1	1	1	1	1	1	1	1	1	1	1	1
11581911	Jumo compression fitting thermocouple			1	1	1	1	1	1	1	1	1	1	1	1	1	1	1	1
12134901	Power regulator in device box	R316 T, PT 100		1	1	1	1	1	1	1	1	1	1	1	1	1	1	1	1
12134902	Power regulator in device box, pressure	R316 T, 0-10V		1	1	1	1	1	1	1	1	1	1	1	1	1	1	1	1
12134903	Power regulator in device box	R316 M, PT 100		1	1	1	1	1	1	1	1	1	1	1	1	1	1	1	1
12134904	Power regulator in device box, pressure	R316 M, 0-10V		1	1	1	1	1	1	1	1	1	1	1	1	1	1	1	1

# 1. Förbränningsdon-Cumbustion device- Verbrennungsvorrichtung-Ensemble de combustion

Namn	Name	Name	Nom	Information	Artikel nr
1 Brännarrör	Flame tube	Brennerrohr	Tube de brûleur	BG 700, L=363 mm	11919401
1 Brännarrör	Flame tube	Brennerrohr	Tube de brûleur	BG 700, L=663 mm	11919402
3 Brännarrör	Flame tube	Brennerrohr	Tube de brûleur	BG 800, L=396 mm	11919501
3 Brännarrör	Flame tube	Brennerrohr	Tube de brûleur	BG 800, L=696 mm	11919502
10 Insats	Nozzle assembly	Düsenstock	Ligne porte-gicleur	BG 700, L=363 mm	11950301
10 Insats	Nozzle assembly	Düsenstock	Ligne porte-gicleur	BG 700, L=663 mm	11950302
10 Insats	Nozzle assembly	Düsenstock	Ligne porte-gicleur	BG 800, L=396 mm	11950201
10 Insats	Nozzle assembly	Düsenstock	Ligne porte-gicleur	BG 800, L=696 mm	11950202
10 Insats	Nozzle assembly	Düsenstock	Ligne porte-gicleur	BG 700, UV, L=363 mm	11950311
10 Insats	Nozzle assembly	Düsenstock	Ligne porte-gicleur	BG 800, UV, L=396 mm	11950221
13 Insatsrör	Tube	Rohr	Tube	BG 700, L=363 mm	11914021
13 Insatsrör	Tube	Rohr	Tube	BG 700, L=663 mm	11914022
13 Insatsrör	Tube	Rohr	Tube	BG 800, L=396 mm	11914031
13 Insatsrör	Tube	Rohr	Tube	BG 800, L=696 mm	11914032
16 Tändelektrod	Ignition electrode	Zündelektrode	Electrode d'allumage		91865501
17 Tändelektrod	Ignition electrode	Zündelektrode	Electrode d'allumage	UV	11534602
18 Joniseringselektrod	Ionization electrode	Ionisationselektrode	Electrode d'ionisation		91837301
20 Klammer	Bracket	Klammer	Crampon		11009903

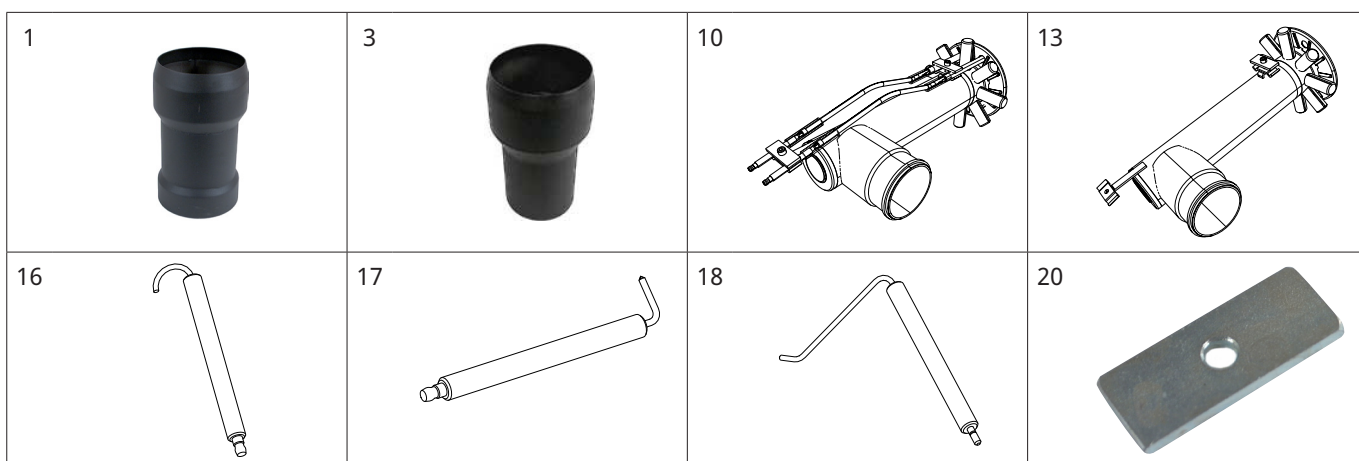

# 1. Förbränningsdon-Cumbustion device- Verbrennungsvorrichtung-Ensemble de combustion

Namn	Name	Name	Nom	Information	Artikel nr
22 O-ring	O-ring	O-ring	Joint torique	81,92X5,34	11316843
24 Bromsskiva, t.o.m serienummer 2495721	Brake plate, even serial number 2495721	Stauscheibe, auch Seriennummer 2495721	Disque accroche-flamme, même numéro de série 2495721	BG 700	11473524
26 Bromsskiva, fr.o.m serienummer 2495722	Brake plate, from the serial number 2495722	Stauscheibe, von der Seriennummer 2495722	Disque accroche-flamme, à partir du numéro de série 2495722	BG 700	92127933
28 Bromsskiva, för brännare före 2007	Brake plate, for burners before 2007	Stauscheibe, Brenner vor 2007	Disque accroche-flamme, brûleur avant 2007	BG 800	12127932
30 Bromsskiva, för brännare efter 2007	Brake plate, for burners after 2007	Stauscheibe, Brenner nach 2007	Disque accroche-flamme, brûleur après 2007	BG 800	92127925
34 Tändkabelsats	Ignition Cable Kit	Zündleitungssatz	Kit de fils d'allumage		12026304
36 Joniseringskabel, sats	Ignition Cable Kit	Zündleitungssatz	Kit de fils d'allumage		12026314
40 Tänd/Joniseringskabel	Ignition/Ionisation cable	Zünd/Jonisationskabel	Câble d'allumage/ionisation	150 mm.	12074815
40 Tänd/Joniseringskabel	Ignition/Ionisation cable	Zünd/Jonisationskabel	Câble d'allumage/ionisation	250 mm.	12074825
40 Tänd/Joniseringskabel	Ignition/Ionisation cable	Zünd/Jonisationskabel	Câble d'allumage/ionisation	550 mm.	12074855

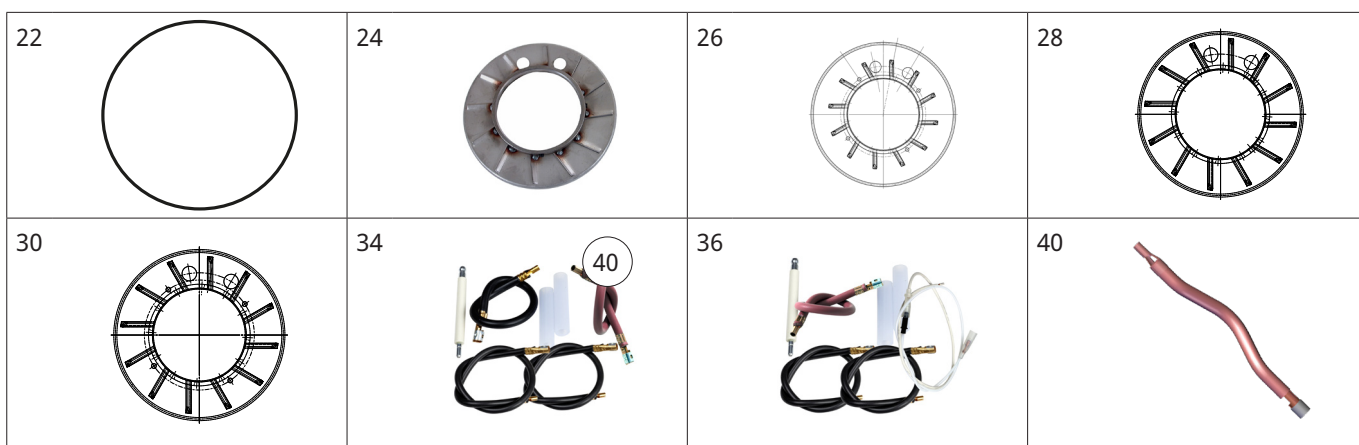

# 1. Förbränningsdon-Cumbustion device- Verbrennungsvorrichtung-Ensemble de combustion

Namn	Name	Name	Nom	Information	Artikel nr
42 Resistanståndkabel	Ignitioncable	Zündkabel	Câble H.T.	250 mm.	12074925
42 Resistanståndkabel	Ignitioncable	Zündkabel	Câble H.T.	450 mm.	12074945
42 Resistanståndkabel	Ignitioncable	Zündkabel	Câble H.T.	500 mm.	12074950
42 Resistanståndkabel	Ignitioncable	Zündkabel	Câble H.T.	550 mm.	12074955
44 Isolator	Insulator	Zündelektrode	Isolateur		11924201
46 Joniseringskabel hona/hane	Ionisation cable, male, female	Jonisationskabel, weiblich/männlich	Câble ionisation, femelle/mâle	500 mm.	12118150
48 Joniseringskabel hona	Ionisation cable, female	Jonisationskabel, weiblich	Câble ionisation, femelle	400 mm.	11865804
50 Tändkabel komplett	Ignitioncable	Zündkabel	Câble H.T.	250/ 500mm.	12026302

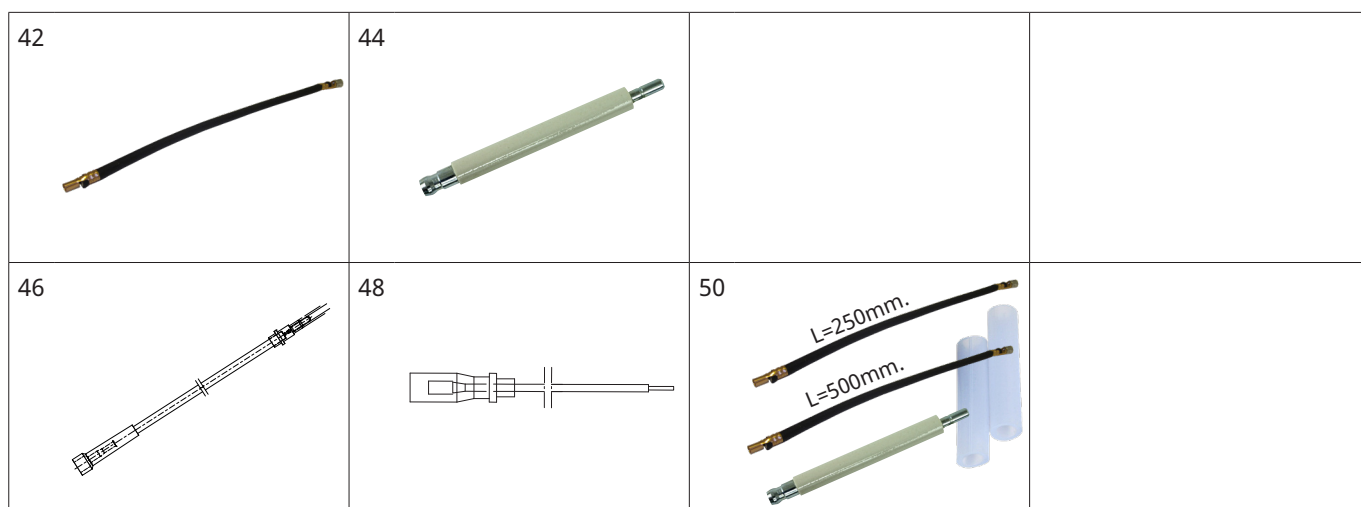

## 2. Motor - Motor - Motor - Moteur

Namn	Name	Name	Nom	Information	Artikel nr
1 Motor	Motor	Motor	Moteur	BG 700, 3.0/3.6kW 50Hz 3F, IP55, 230/400V	12115401
5 Motor	Motor	Motor	Moteur	BG 700, BG 800, 3.0/3.6kW 50/60Hz 3F, IP55, 230/400V	12115501
8 Fläkthjul	Fan wheel	Gebläserad	Rotor	BG 700	11277607
8 Fläkthjul	Fan wheel	Gebläserad	Rotor	BG 800	11277622
10 Motorfläns	Flange, motor	Flansch, motor	Bride, moteur	BG 700, BG 800	1190430105
12 Avskärningskon	Conical shield plate	Abschirmkonus	Cone deflecteur d'air	BG 700	11914401
14 Avskärningskon	Conical shield plate	Abschirmkonus	Cone deflecteur d'air	BG 800	11906201
16 Motorkabel	Cable motor	Kabel Motor	Câble moteur	4x1.5 3F, BG 700	11944903
18 Motorkabel	Cable motor	Kabel Motor	Câble moteur	4x2.5 3F, BG 800	11944902















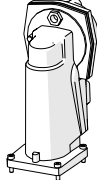

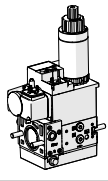
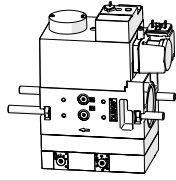
### 3. Gasventil - Gas Valve - Gasventil - Vanne de gaz - (MultiBloc)

Namn	Name	Name	Nom	Information	Artikel nr
1 Gasventil (MultiBloc)	Gas valve (MultiBloc)	Gasventil (MultiBloc)	Vanne de gaz (MultiBloc)	DLE415B01S52 GW150	12100801
3 Gasventil (MultiBloc)	Gas valve (MultiBloc)	Gasventil (MultiBloc)	Vanne de gaz (MultiBloc)	DLE420B01S52 GW150	12100901
5 Gasventil (MultiBloc)	Gas valve (MultiBloc)	Gasventil (MultiBloc)	Vanne de gaz (MultiBloc)	VEF415B01S32 GW150	11851138
7 Gasventil (MultiBloc)	Gas valve (MultiBloc)	Gasventil (MultiBloc)	Vanne de gaz (MultiBloc)	VEF420B01S32 GW150	11851139
9 Restriktor, flödesjustering	Restrictor flow adjustment	Drosseldurchflusseinstellung	Réglage du débit du restricteur	BG 700 Bio	11996501
11 Tryckregulator	Pressure adjustment valve	Druckreglerventil	Vanne de reglage de pression	FRS520 10-30 MBAR	11478045
13 Magnetventil	Solenoid valve	Magnetventil	Électrovanne	MVD 220/5 SER02	11984503
15 Magnetventil	Solenoid valve	Magnetventil	Électrovanne	DMV-DLE 525/11	11979805
17 Gasventil (MultiBloc)	Gas valve (MultiBloc)	Gasventil (MultiBloc)	Vanne de gaz (MultiBloc)	VEF425B01S32	11851147
19 Gasventil (MultiBloc)	Gas valve (MultiBloc)	Gasventil (MultiBloc)	Vanne de gaz (MultiBloc)	ZRDLE415B01S50	11567173
21 Ventilblock gas	Valve block gas	Ventilblockgas	Bloc vannes gaz	VGD40.080	12104801

1		3		5		7	
9		11		13		15	
17		19		21			

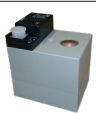
### 3. Gasventil - Gas Valve - Gasventil - Vanne de gaz - (MultiBloc)

Namn	Name	Name	Nom	Information	Artikel nr
23 Ställdon	Actuator	Aktuator	Actionneur	SKP15	12079001
25 Ställdon	Actuator	Aktuator	Actionneur	SKP25	12079101
27 Gasventil (MultiBloc)	Gas valve (MultiBloc)	Gasventil (MultiBloc)	Vanne de gaz (MultiBloc)	ZRDLE420BO1S50	11567174
29 Gasventil (MultiBloc)	Gas valve (MultiBloc)	Gasventil (MultiBloc)	Vanne de gaz (MultiBloc)	VEF425BO1S32 GW150	11851137
31 Gasventil (MultiBloc)	Gas valve (MultiBloc)	Gasventil (MultiBloc)	Vanne de gaz (MultiBloc)	ZRDLE412BO1S50	11567189
33 Gasventil (MultiBloc)	Gas valve (MultiBloc)	Gasventil (MultiBloc)	Vanne de gaz (MultiBloc)	MULTIBLOCK VEF412BO1S30	11851104
35 Spole	Coil	Spule	Bobine	MB-ZRDLE 410/412/415 S1	11568813
37 Spole	Coil	Spule	Bobine	MB-ZRDLE 410/412/415 ST2	11568815
39 Spole Steg1	Coil Stage 1	Spule Stufe 1	Bobine 1ère étape	ZRDLE420	11568816
40 Spole Steg2	Coil Stage 2	Spule Stufe 2	Bobine 2ème allure	ZRDLE420	11568817
42 Spole	Coil	Spule	Bobine	VEF 412/415 1205	11568823
43 Spole	Coil	Spule	Bobine	VEF420 1215	11568824
44 Spole	Coil	Spule	Bobine	VEF425 1405	11568825
46 Filtersats	Filter set	Filtersatz	Jeu de filtre	410/412 XR	11916501
47 Filtersats	Filter set	Filtersatz	Jeu de filtre	410/412	11916511
48 Filtersats	Filter set	Filtersatz	Jeu de filtre	415/420	11916601

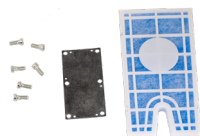
23		25		27		29	
31		33		35		37	
39		40		42		43	
44		46		47		48	

### 3. Gasventil - Gas Valve - Gasventil - Vanne de gaz - (MultiBloc)

Namn	Name	Name	Nom	Information	Artikel nr
50 Täthetskontroll	Valve, leak tester	Dichtkontrolle	Controle d'étanchéité	VPS 504SO2	11861701
52 Tryckvakt	Pressure switch	Druckwächter	Pressostat	LGW 50A2 2,5-50 MBAR	11531907
53 Tryckvakt	Pressure switch	Druckwächter	Pressostat	GW 50A6	91531929
54 Tryckvakt	Pressure switch	Druckwächter	Pressostat	GW 50A5, 5-50 MBAR	11531926
55 Tryckvakt	Pressure switch	Druckwächter	Pressostat	GW 150A5, 10-150 MBAR	11531927
57 Tryckvakt gas	Pressure switch gas	Druckwächter gas	Pressostat gaz	QPL15.150	12079704
59 Fläns	Flange	Flansch	Bride	1 1/2", 415/420	11899201
60 Fläns	Flange	Flansch	Bride	2", 415/420	11899202
61 Fläns	Flange	Flansch	Bride	2", 425	11899302
63 Fläns	Flange	Flansch	Bride	1 1/4", 410/412	11566713
64 Fläns	Flange	Flansch	Bride	1 1/4", 410/412	11566718
65 Impulsfläns	Impulse flange	Impulsflansch	Bride d'impulsions	VEF 412	11968402
65 Impulsfläns	Impulse flange	Impulsflansch	Bride d'impulsions	VEF 415	11968403
65 Impulsfläns	Impulse flange	Impulsflansch	Bride d'impulsions	VEF 420	11968404
65 Impulsfläns	Impulse flange	Impulsflansch	Bride d'impulsions	VEF 425	11968405
67 Mät nipple	Test nipple	Messnippel	Raccord de mesure	R1/8"xØ8	11542701
68 Mät nipple	Test nipple	Messnippel	Raccord de mesure	R1/8"xØ8	12074501
69 Impulsrör, eldstad	Impulse tube, furnace	Impulsrohr, Herd	Tube d'impulsions, foyer		12078231
69 Impulsrör, fläkt	Impulse tube, fan	Impulsrohr, Ventilator	Tube d'impulsions, ventilateur		12078232
69 Impulsrör, gas	Impulse tube, gas	Impulsrohr, gas	Tube d'impulsions, gaz		12078233



### 3. Gasventil - Gas Valve - Gasventil - Vanne de gaz - (MultiBloc)

Namn	Name	Name	Nom	Information	Artikel nr
69 Impulsrör, metervara	Impulse tube, by the meter	Impulsrohr, Metervare	Tube d'impulsions, marchandise métrique	Ø6,0x1,0 fz	23107700
71 Vinkelkoppling	Elbow	Winkelkupplung	Coude	1/8"	11545201
72 Koppling rak	Coupling straight	Kupplung gerade	Raccord droit.	1/8"	11545101
73 Nippel	Nipple	Nippel	Raccord	R1/8" x G1/8"	11469301
74 Nippel	Nipple	Nippel	Raccord	1 1/2" x 1 1/2"	11463703
74 Nippel	Nipple	Nippel	Raccord	2" x 2"	11463704
74 Nippel	Nipple	Nippel	Raccord	1 1/2" x 1 1/4"	11463708

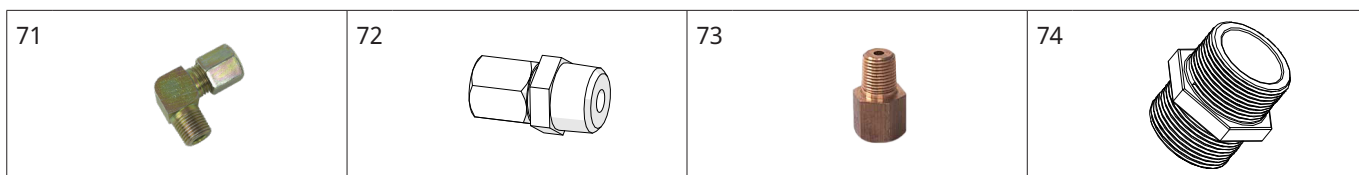

### 3. Gasventil - Gas Valve - Gasventil - Vanne de gaz - (MultiBloc)

Namn	Name	Name	Nom	Information	Artikel nr
76 Förbindelserör	Connecting pipe	Öldruckrohr	Conduite de raccordement	1 1/2"	11944220
76 Förbindelserör	Connecting pipe	Öldruckrohr	Conduite de raccordement	1 1/2"	11944201
76 Förbindelserör	Connecting pipe	Öldruckrohr	Conduite de raccordement	1 1/4"	11981801
76 Förbindelserör	Connecting pipe	Öldruckrohr	Conduite de raccordement	2"	11944401
76 Förbindelserör, mätstos	Connecting pipe, test outlet	Öldruckrohr, messausgang	Conduite de raccordement, raccord de mesure	2"	11944420
76 Förbindelserör	Connecting pipe	Öldruckrohr	Conduite de raccordement	DN 65	11907320
76 Förbindelserör	Connecting pipe	Öldruckrohr	Conduite de raccordement	DN 80	11907020
77 Gasfilter	Gas filter	Gas-Filter	Filtre gaz	2" 70631/6B	11395406
77 Gasfilter	Gas filter	Gas-Filter	Filtre gaz	DN65 70610F/6B	11395407
77 Gasfilter	Gas filter	Gas-Filter	Filtre gaz	DN80 70620F/6B	11395408
78 Filtersats	Filter kit	Filter Kit	Kit de filtre	3218/6B	12143002
78 Filtersats	Filter kit	Filter Kit	Kit de filtre	3226	12143003

Gasfilter		Filter kit	
11395403	GASFILTER 1" 70602/6B	12143001	FILTERSATS 1"-1 1/2" 3217/6B
11395405	GASFILTER 1 1/2" 70603/6B	12143001	FILTERSATS 1"-1 1/2" 3217/6B
11395406	GASFILTER 2" 70631/6B	12143002	FILTERSATS 2" 3218/6B
11395407	GASFILTER DN65 70610F/6B	12143003	FILTERSATS DN65-80 3226
11395408	GASFILTER DN80 70620F/6B	12143003	FILTERSATS DN65-80 3226

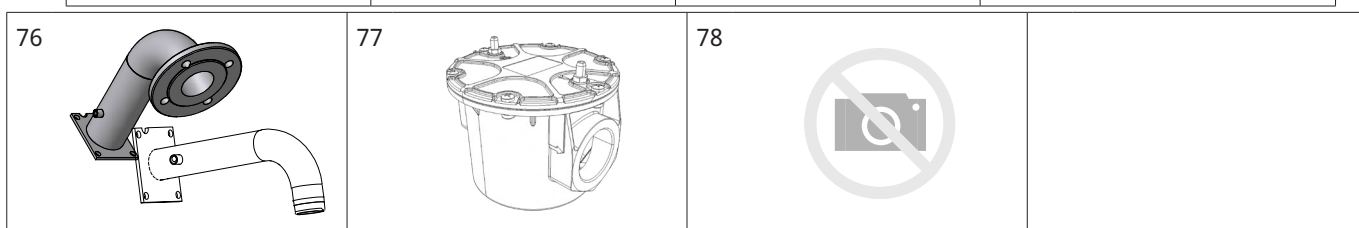

### 3. Gasventil - Gas Valve - Gasventil - Vanne de gaz - (MultiBloc)

Namn	Name	Name	Nom	Information	Artikel nr
79 Spjällmotor, gas	Damper motor, gas	Klappenmotor, gas	Moteur de volet, gaz	SQM33	12101601
80 Gasspjäll	Gas damper	Gasklappe	Volet d'gaz	DMK 515/1,5" Ø32	12102201
80 Gasspjäll	Gas damper	Gasklappe	Volet d'gaz	520/2,00" Ø40	12102301
81 Gasspjäll	Gas damper	Gasklappe	Volet d'gaz	VKG10.040ER	12120602
81 Gasspjäll	Gas damper	Gasklappe	Volet d'gaz	VKG10.050ER	12120603
83 Gasspjäll	Gas damper	Gasklappe	Volet d'gaz	VKF10.080	12135002
85 Packning, plan	Gasket	Dichtung	Joint	DN 80	11524303
87 Kulventil, rak	Ball valve, straight	Kugelhahn, gerade	Vanne à boule, droite	1 1/2"	11396104
87 Kulventil, rak	Ball valve, straight	Kugelhahn, gerade	Vanne à boule, droite	2"	11396105
88 Kulventil	Ball valve	Kugelventil	Vanne à bille	KSN75 DN65	11524601
88 Kulventil	Ball valve	Kugelventil	Vanne à bille	KSN75 DN80	11524602
90 Adapter set GW Dungs	Adapter kit GW Dungs	Adapter Satz GW Dungs	Adapteur kit GW Dungs	VPS 504	12127101
92 Tätningsring	Sealing ring	Dichtungsring.	Anneau d'étanchéité.	1/4"	11983301

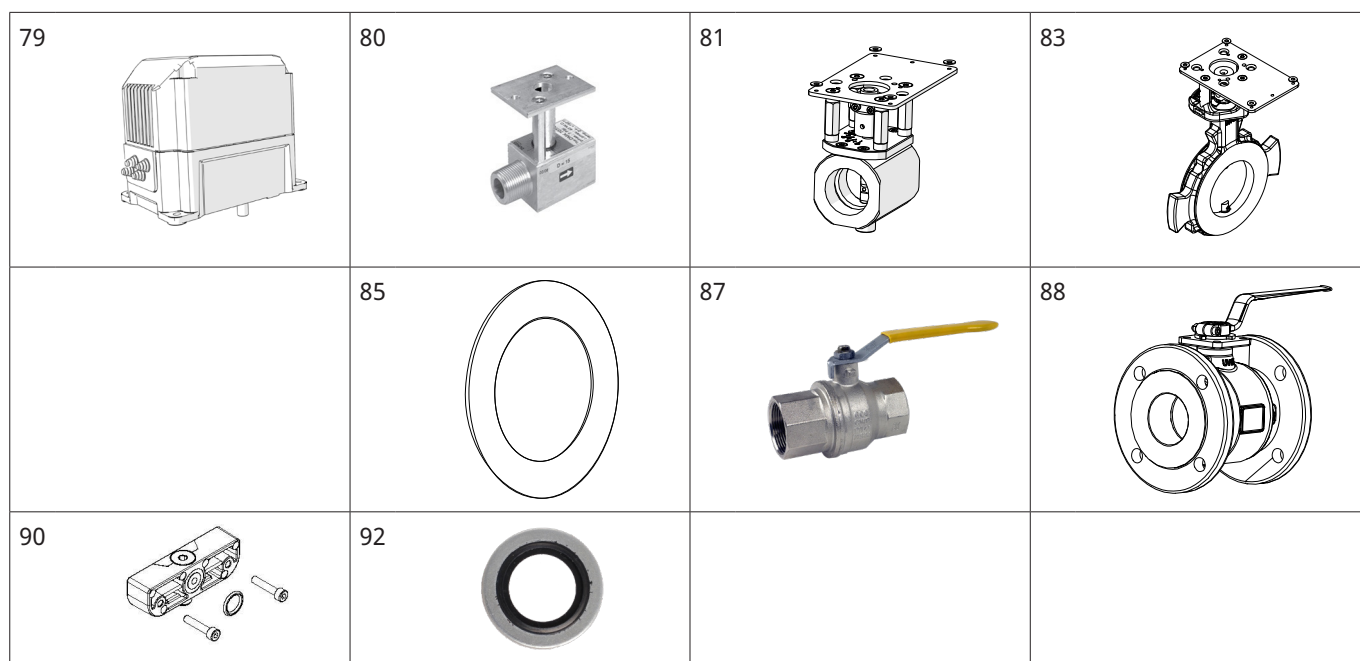

## 4. Elkomponenter - Electrical components - Elektrische Komponenten - Composants électriques

Namn	Name	Name	Nom	Information	Artikel nr
1 Reläbox	Control box	Steuergerät	Boite de relais	LFL 1.333E	11463204
3 Styrautomat	Automatic control unit	Automatisches Steuergerät	Module de commande automatique	BP230UVFR-S2	12122501
5 Reläsockel	Base, control box	Unterteil, Steuergerät	Socle de raccordement		11463300
7 Flamdetektor	Flame detector	Flammendetektor	Détecteur de flamme	UV 5-2	12122901
9 Fläns, flamdetektor	Flange, flame detector	Flansch, Flammendetektor	Bride, détecteur de flamme	UV 5-2	12126601
12 Kontaktor	Contacteur	Schütz	Contacteur	LC1D09P7	12143101
12 Kontaktor	Contacteur	Schütz	Contacteur	LC1D18P7	12143102
12 Kontaktor	Contacteur	Schütz	Contacteur	LC1D25P7	12143103
14 Motorskydd	Thermal overload protection	Überstromschutz	Déclencheur à maxima d'intensité	5.5-8.0 A	12143205
14 Motorskydd	Thermal overload protection	Überstromschutz	Déclencheur à maxima d'intensité	9.0-13.0 A	12143208
14 Motorskydd	Thermal overload protection	Überstromschutz	Déclencheur à maxima d'intensité	16.0-24.0 A	12143212
16 Säkringshållare	Holder, fuse	Halter, Sicherung	Support, fusible		11333201
17 Säkring	Fuse	Sicherung	Fusible	6,3A	11811803

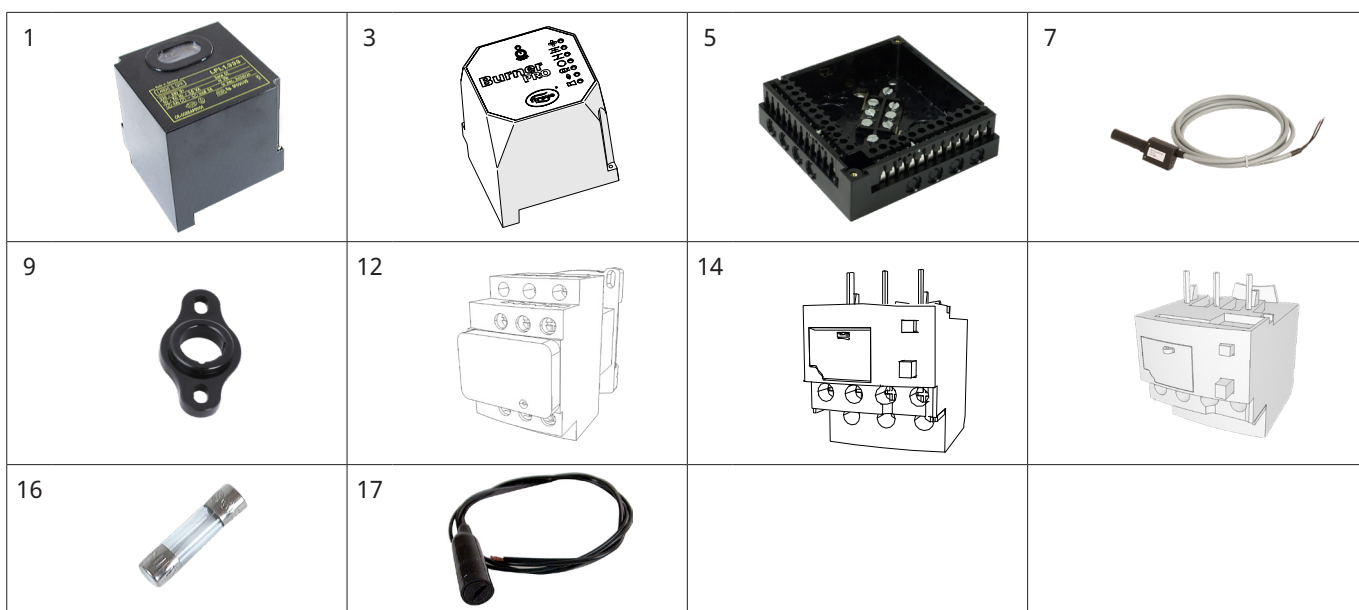

## 4. Elkomponenter - Electrical components - Elektrische Komponenten - Composants électriques

Namn	Name	Name	Nom	Information	Artikel nr
19 Transformator, kompl.	Transformer compl.	Transformator kompl.	Transformateur compl.	Fida	11852303
20 Kabel, transformator	Cable, transformer	Kabel, Transformator	Câble, transformateur	FIDA L=700mm	11804702
22 Transformator, kompl.	Transformer compl.	Transformator kompl.	Transformateur compl.	Fida	92043202
24 Kabel, transformator	Cable, transformer	Kabel, Transformator	Câble, transformateur	FIDA L=700mm	11804701
26 Transformator	Transformer	Transformator	Transformateur	Fida	11804601
27 Transformator	Transformer	Transformator	Transformateur	Fida	12043201
29 Strömbrytare	Switch	Schalter	Interrupteur	0-I	12132201
31 Strömbrytare	Switch	Schalter	Interrupteur	I-II	12132202
33 Omkopplare, manuell-automatisk	Switch, manuel-automatik	Umschalter, manuell-automatisch	Commutateurs, manuel-automatique		12132203
34 Omkopplare, öka-minska	Switch, increase-decrease	Umschalter, erhöhen-reduzieren	Commutateurs, augmenter-réduire		11784302
36 Indikeringslampa, grön	Indication lamp, green	Anzeigelampe, grün	Voyant lumineux, vert		11721103
38 Kontaktdon 7+4+5+4 pol kompl.	Plug-in contact 7+4+5+4-pole compl.	Steckerteil 7+4+5+4-polig kompl.	Fiche de prise de courant 7+4+5+4-polaire compl.	BG 700-2	11948601
38 Kontaktdon 7+4+5+4 pol kompl.	Plug-in contact 7+4+5+4-pole compl.	Steckerteil 7+4+5+4-polig kompl.	Fiche de prise de courant 7+4+5+4-polaire compl.	BG 700M	11948612

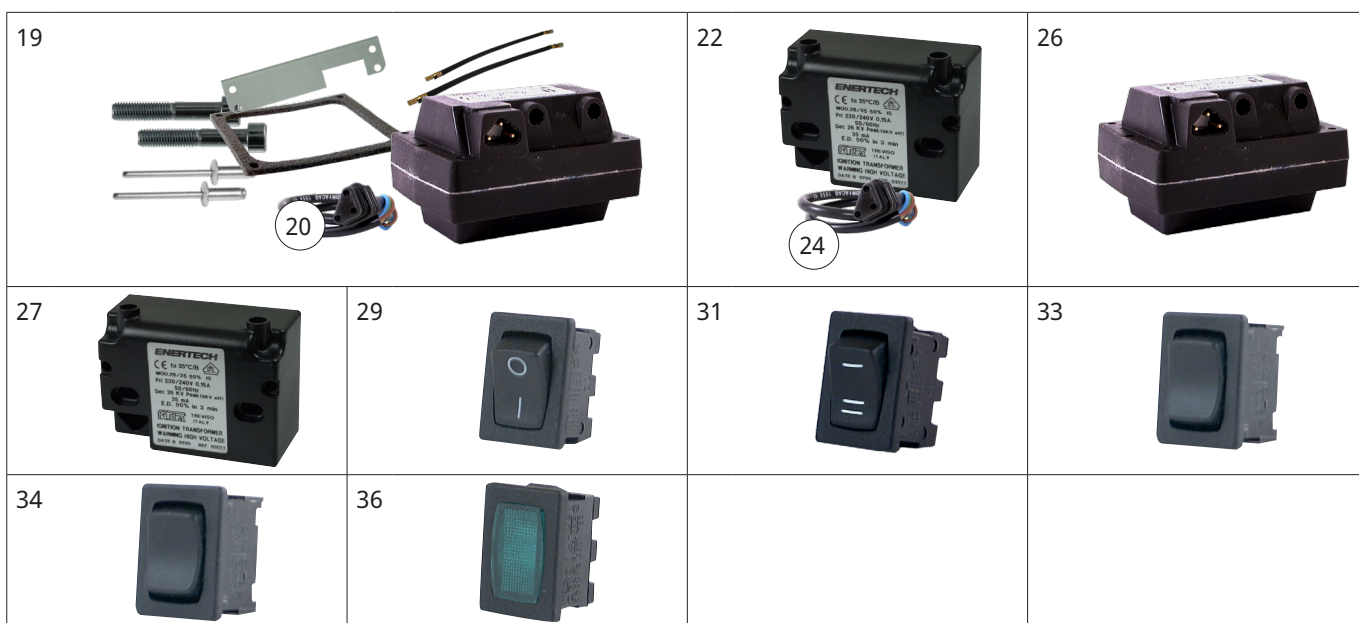



## 4. Elkomponenter - Electrical components - Elektrische Komponenten - Composants électriques

Namn	Name	Name	Nom	Information	Artikel nr
40 Kontaktdon 7+4+5+4 pol kompl.	Plug-in contact 7+4+5+4-pole compl.	Steckerteil 7+4+5+4-polig kompl.	Fiche de prise de courant 7+4+5+4-polaire compl.	BG 800M	11948613
42 5 pol, hona	5-pole, female	5-polig, Buchsenteil	5-polaire, femelle		11920001
43 5 pol, hane	5-pole, male	5-polig, Stecker	5-polaire, mâle		11919901
45 7 pol, hona	7-pole, female	7-polig, Buchsenteil	7-polaire, femelle	BG 700	91558501
46 7 pol, hona	7-pole, female	7-polig, Buchsenteil	7-polaire, femelle	BG 800	11558603
48 7 pol, hane	7-pole, male	7-polig, Stecker	7-polaire, mâle		11558500
50 4 pol, hona	4-pole, female	4-polig, Buchsenteil	4-polaire, femelle		11919801
52 4 pol, hane	4-pole, male	4-polig, Stecker	4-polaire, mâle		11919701
55 Kontaktdon, magnetventil, hona V0	Plug-in contact, solenoid valve, female V0	Buchsenteil, Magnetventil, Weiblich V0	Fiche de prise de courant, electrovanne, femelle V0		11421616
57 Kontaktdon, gasvakt V0 hona	Plug-in contact, gas guard V0 female	Buchsenteil, Gaswächter V0, Weiblich	Fiche de prise de courant, garde de gaz V0, femelle		11421624
59 Display	Display	Display	Afficheur	AZL.23	12101101
61 Kabel, display	Cable, display	Kabel, Display	Câble, Afficheur	AZL.23, L= 186,4 mm	12106301
63 Styrautomatik	Automatic control unit	Automatisches Steuergerät	Module de commande automatique	LMV37 ver. 4	12101004

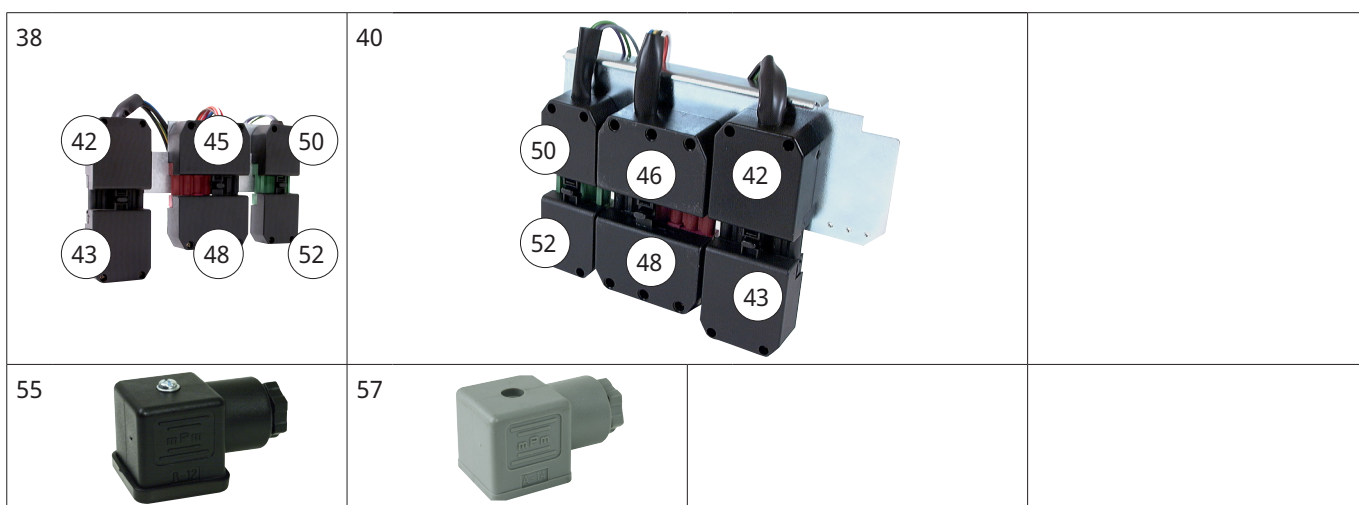

## 4. Elkomponenter - Electrical components - Elektrische Komponenten - Composants électriques

Namn	Name	Name	Nom	Information	Artikel nr	
65	Kontaktidon sats	Plug-in-contact set	Stecker Satz	Kit de conecteur	AGG3.132, X3-X75, LMV	12106200
67	Magnetventilkabel	Cable, solenoid valve	Kabel, Magnetventil	Câble, électrovanne	Hirshmann	12106001
69	Kabel, lufttryckvakt	Cable, air pressure switch	Kabel, Luftdruckwächter	Câble, pressostat air		12142505

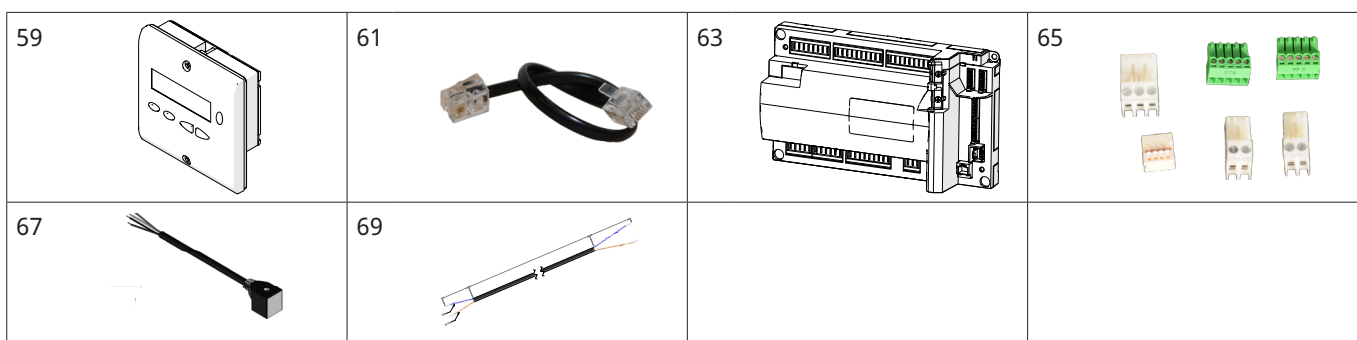

## 5. Luftreglering - Air control - Luftsteuerung - Régularisation à air

Namn	Name	Name	Nom	Information	Artikel nr
1 Spjällmotor, 2-steg	Damper motor, 2-stage	Klappenmotor, 2-stufig	Moteur de volet, 2 allures	BG 700, LMG, SQN75.254.A21B	11942310
1 Spjällmotor, modulerande	Damper motor, modulationg	Klappenmotor, modullerend	Moteur de volet, modullant	SQN75.664A21B	11942305
3 Spjällmotor, modulerande	Damper motor, modulationg	Klappenmotor, modullerend	Moteur de volet, modullant	BG 700i M, SQM 33	12101601
6 Luftspjäll kompl.	Air damper compl.	Luftklappe kompl.	Volet d'air compl.		11946301
8 Nippel	Nipple	Nippel	Raccord		11542301
10 Länkkarm kompl.	Slewing bracket compl.	Gelenkarm kompl.	Pivot compl.		11947001
12 Slangnippel	Nipple, flexible pipe	Nippel, Ölschlauch	Raccord pour flexible V4*1/8		11575301

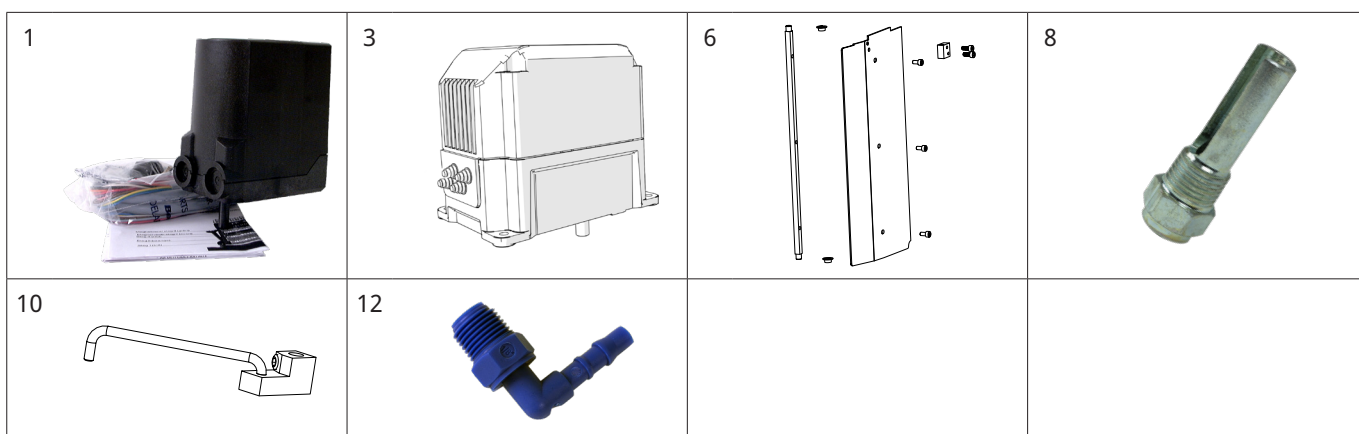

## 6. Fläkthus - Fan housing - Lüftergehäuse - Carter de ventilateur

Namn	Name	Name	Nom	Information	Artikel nr
1 Anslutningsfläns kompl.	Fixing flange compl.	Anschlussflansch kompl.	Bride de fixation compl.		91914601
3 Anslutningsfläns	Fixing flange	Anschlussflansch	Bride de fixation		11914601
5 Gejder	Guide	Führungsschienen	Guides		1191420105
9 Packning, fläktusfläns, plåt	Gasket, fan housing/flange, metal	Dichtung, Brennerhäuse-Flansch, Blech	Joint, carter du rotorbride, lame		11922601
10 Packning, fläktusfläns	Gasket, fan housing/flange	Dichtung, Brennerhäuse-Flansch	Joint, carter du rotorbride		12134301
12 Packning	Gasket	Dichtung	Joint		11278807
14 Lock	Cover	Deckel	Couvercle		1191500005
16 Packning, lock	Gasket, cover	Dichtung, Deckel	Joint, couvercle		11915101
18 Skyddsgaller	Protective grating	Schutzgitter	Grille de protection		11904801
20 Kåpa, inspektionsglas	Cover, inspection glass	Haube, Schauglas	Capot, viseur de flamme		1190660105
22 Inspektionslock	Inspection cover	Deckel, Schauglas	Couvercle, viseur de flamme		11708001
24 Säkringsring	Locking ring	Sicherungsring	Circlip		11801801
26 Inspektionsglas	Inspection glass	Schauglas	Voyant liquide		11808801
28 Packning, inspektionsglas	Gasket, inspection glass	Dichtung, Inspektionsglas	Joint, verre d'inspection		11795301
30 Lock, fotomotstånd	Cover, photoresistor	Deckel, Fotowiderstand	Couvercle, cellule photorésistante		11173101

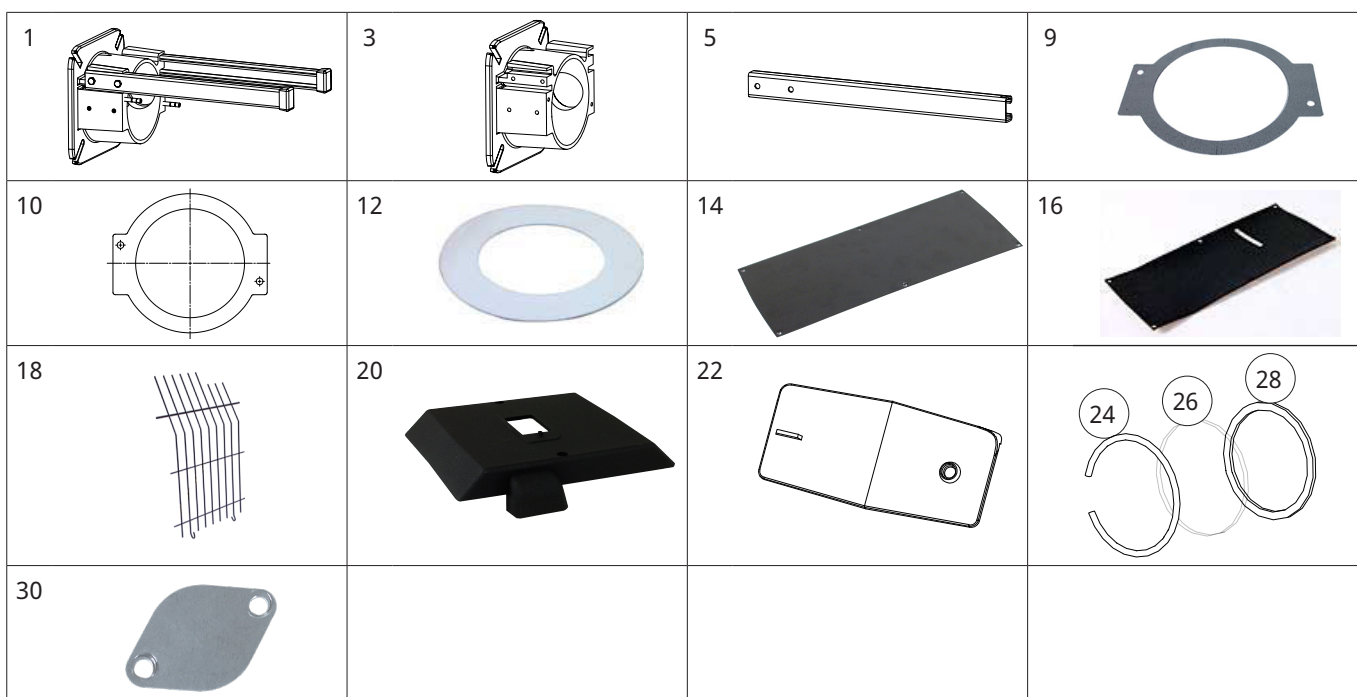

## 7. Tillbehör - Accessories - Zubehör - Accessoires

Namn	Name	Name	Nom	Information	Artikel nr
1 Magnetventilsats, kontinuerlig fläkt	Solenoid Valve Kit, continuous fan	Magnetventil-Set, kontinuierliche Fan	Électrovanne Kit, ventilateur continue		11923001
3 Effektvakt	Power switch	Leistungsbegrenzer	Limiteur de puissance	ÜB50/A2	11950701
5 Euro-kontakt, brännare extern reset	Plug-in contact, burner external reset	Eurostecker, Brenner Externe Rückstellung	Prise européenne, réarmement externe, brûleur		92062401
7 Modbusenhet (utgående artikel)	Modbus unit (outgoing article)	Modbusgerät (ausgehendes Produkt)	Unité Modbus (produit périmé)	OCI 412	92101901



## 7. Tillbehör - Accessories - Zubehör - Accessoires

Namn	Name	Name	Nom	Information	Artikel nr
10 Effektregulator	Power control	Leistungsregler	Régulateur de puissance	R316 T, PT 100	12052601
10 Effektregulator, tryck	Power control, pressure	Leistungsregler, druck	Régulateur de puissance, pression	R316 T, 0-10V	12052602
10 Effektregulator	Power control	Leistungsregler	Régulateur de puissance	R316 M, PT 100	12052701
10 Effektregulator, tryck	Power control, pressure	Leistungsregler, druck	Régulateur de puissance, pression	R316 M, 0-10V	12052702
12 Transformator	Transformer	Transformator	Transformateur	HDR-15-24 220 VAC/24 VDC	12133901
14 Givare	Sensor	Fühler	Sonde	PT 100	11581902
16 Jumo tryckgivare	Jumo pressure transmitter	Jumo Drucktransmitter	Jumo transmetteur de pression	0-1 bar	11581905
16 Jumo tryckgivare	Jumo pressure transmitter	Jumo Drucktransmitter	Jumo transmetteur de pression	0-10 bar	11581906
16 Jumo tryckgivare	Jumo pressure transmitter	Jumo Drucktransmitter	Jumo transmetteur de pression	0-16 bar	11581907
18 Jumo termoelement	Jumo thermocouple	Jumo Thermoelement	Jumo thermocouple	-200 - 1500	11581910
20 Jumo klämförskruvning termoelement	Jumo compression fitting thermocouple	Jumo, Klemmverschraubung für Thermoelemente	Jumo raccord à vis de serrage pour thermocouples		11581911

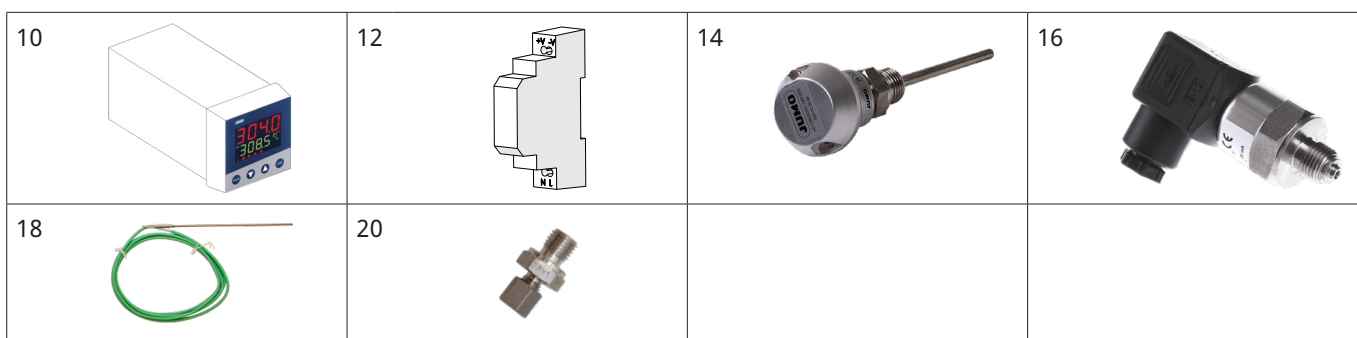

## 7. Tillbehör - Accessories - Zubehör - Accessoires

Namn	Name	Name	Nom	Information	Artikel nr
23 Effektregulator, kapslad	Power regulator in device box	Leistungsregler im Gerätekasten	Régulateur de puissance dans la boîte de l'appareil	R316 T, PT 100	12134901
23 Effektregulator, kapslad, tryck	Power regulator in device box, pressure	Leistungsregler im Gerätekasten, druck	Régulateur de puissance dans la boîte de l'appareil, pression	R316 T, 0-10V	12134902
23 Effektregulator, kapslad	Power regulator in device box	Leistungsregler im Gerätekasten	Régulateur de puissance dans la boîte de l'appareil	R316 M, PT 100	12134903
23 Effektregulator, kapslad, tryck	Power regulator in device box, pressure	Leistungsregler im Gerätekasten, druck	Régulateur de puissance dans la boîte de l'appareil, pression	R316 M, 0-10V	12134904

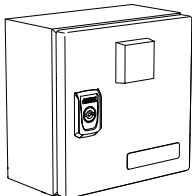
23				
----	---	--	--	--



CTC AB Box 309 SE-341 26 Ljungby

[info@bentone.se](mailto:info@bentone.se) +46 372 88 000

[www.bentone.se](http://www.bentone.se)