



Providing sustainable energy solutions worldwide

Installation- and maintenance instruction

ST 133 S, SV

LMO14.113C2E

AS47CK



-sv

1. Manualer på övriga språk

2. [www.bentone.com\download](http://www.bentone.com/download) eller scanna QR-koden.

3. Skriv in brännarens artikelnummer som finns på din typskylt (se bild) och välj ditt språk.

Detaljerad ecodesign information kan laddas ner på: www.bentone.com/ecodesign.

-da

1. Manualer på andre sprog

2. [www.bentone.com\download](http://www.bentone.com/download) eller scan QR-koden.

3. Indtast brænderens artikelnummer, der findes på typeskiltet (se billede), og vælg dit sprog.

Detaljerede oplysninger om ecodesign kan downloades på: www.bentone.com/ecodesign.



-en

1. Manuals in other languages

2. [www.bentone.com\download](http://www.bentone.com/download) or scan QR-code.

3. Enter the burner's article number on your data plate (see picture) and select language.

Detailed ecodesign information can be downloaded at: www.bentone.com/ecodesign.

-de



1. Gebrauchsanweisungen in anderen Sprachen

2. [www.bentone.com\download](http://www.bentone.com/download) oder scannen Sie den QR-Code.

3. Geben Sie die Artikelnummer des Brenners auf Ihrem Typenschild ein, (siehe Bild) und wählen Sie die Sprache aus.

Detaillierte Informationen zum Ecodesign können unter www.bentone.com/ecodesign heruntergeladen werden.

3. exempel example Beispiel

352011030141	Serial no. 1234567	Man.Year 2019
Designation	BF 1 KS 76-24	
Type	BF 1	
Model	BF 1 KS 76-24	
Cap. Min-Max	LIGHT OIL 35-90KW 1,25-6,0 cSt 7-14bar	
Main supply	1-230V 1,0A 50Hz IP 20	
Motor supply		
MADE IN SWEDEN BY		

-fr

1. Manuels dans d'autres langues

2. [www.bentone.com\download](http://www.bentone.com/download) ou scannez le code QR.

3. Saisir le numéro d'article du brûleur sur votre plaque signalétique (consultez l'illustration) et sélectionnez la langue.

Des informations détaillées sur l'écodesign peuvent être téléchargées à l'adresse: www.bentone.com/ecodesign.

Table of contents

1. Safety Information	4
2. Technical data	7
2.1 Dimensions ST 133	7
2.2 Burner installation	8
2.3 Working field ST 133 S, SV	8
2.4 Electric Specification	8
2.5 Setting of brake plate and air flow	8
2.6 Recommended nozzles and pressures	9
2.7 Nozzle table, 8-15 bar	9
2.8 Description	10
3. General instructions	11
3.1 General instructions	11
3.2 Delivery inspection	12
3.3 Preparing for installation	12
3.4 Oil distribution	12
3.5 Electrical connection	12
3.6 Burner installation	13
4. Basic settings	14
4.1 Example of basic settings	14
5. Burner servicing	16
5.1 Servicing	16
5.2 Servicing the combustion device	16
5.3 Replacing the oil pump	18
5.4 Replacing the fan motor and fan wheel	19
5.5 Servicing the air intake and intake cone	20
5.6 Replacing the entire electrical package	20
5.7 Replacing individual electrical package components	21
6. Instructions Pump	22
6.1 SUNTEC AS	22
7. Oil burner control	28
7.1 Wiring diagram	28
7.2 Colour codes LMO14/24	30
7.3 Fault codes LMO14/24	30
8. Fault Location	31
8.1 Burner will not start	31
8.2 Burner will not start after normal use	31
8.3 Delayed ignition	32
8.4 Noise in pump	32
8.5 Pump pressure	33
9. Log of flue gas analysis	35
10. Oil burners maintenance instructions	36

1. Safety Information

This Installation and Maintenance manual:

- is to be regarded as part of the burner and must always be kept near the installation site.
- is intended for use by authorised personnel.
- must be read prior to installation.
- must be observed by all who work with the burner and associated system components.
- work with the burner may only be carried out by certified installers/ personnel.
- Enertech AB is not liable for any typographical errors and reserves the right to make design changes without prior notice.
- The burner may only be used for its intended purpose in accordance with the product's technical data.
- The burner may only be installed and operated by authorised personnel.
- The product is packaged to prevent damage from occurring during handling. Handle the product with care. Lifting equipment must be used to lift larger packages.
- The products must be transported/stored on a level surface in a dry environment, max. 80% relative humidity, no condensation. Temperature -20 to +60 °C.
- Check that the burner is compatible with the boiler's output range.
- The label information on the rating plate refers to the burner's minimum and maximum power.
- The power data on the type sign refers to the burner's min. and max. power.
- All components must be installed without being bent, twisted or subjected to mechanical or thermal forces which can affect the components.
- The burner must be installed so that it complies with local regulations for fire safety, electrical safety, and fuel distribution.
- Make sure when installing the equipment that there is enough space to service the burner.
- Permitted ambient temperature during operation -0 to +60 °C. Max 80% relative humidity, no condensation.
- The installer must ensure that the room has adequate air supply.
- The room must comply with local regulations pertaining to its intended use.
- The installation site must be free of chemicals.
- Burner pipes, fan wheels and air dampers may contain sharp edges.
- The surface temperature of the burner's components can exceed 60 °C.
- Caution: The burner has moving parts, and there is risk of crushing injuries.



165 105 01

- The electrical installation must be professionally carried out in accordance with applicable high voltage regulations, as per Enertech's recommendations.
- Before servicing, shut off the fuel supply and turn off the power to the burner.
- Leak checks must be performed during installation and servicing to prevent fuel leakage.
- Care should be taken by the installer to ensure that no electrical cables or fuel lines are crushed or otherwise damaged during installation or servicing.
- If the boiler is equipped with an access hatch, this must be equipped with a hatch opening switch connected to the burner's safety system.
- When in operation, the burner's noise level can exceed 85 dBA. Use hearing protection.
- The burner must not be put into operation without proper safety and protection devices.
- A Class BE fire extinguisher is recommended.
- It is forbidden to alter the design or use accessories which have not been approved by Enertech in writing.
- Prior to operation, the following points must be checked:
 - fitting and installation work has been completed and approved.
 - electrical installation has been correctly performed.
 - flue gas ducts and combustion air ducts are not blocked.
 - all actuators and control and safety devices are in working order and correctly set.
- After commissioning, if a steady red light on the burner control is displayed, contact your installation technician.



Burner servicing schedule

Servicing must be carried out once a year or after 3000 hours of operation.

Burner	1 year	3000 hrs
Filter	1 year	3000 hrs Change
Oilhose	1 year Control/change	
Nozzle	1 year Change	3000 hrs Change
Electrods	1 year Change/cleaning	3000 hrs Change/cleaning
Brake plate	1 year Change/cleaning	3000 hrs Change/cleaning
Motor	1 year	3000 hrs
Cuppling chaft	1 year Control/change	3000 hrs Control/change
Fan wheel	"1 year Change when dirty / unbalance"	"3000 hrs Change when dirty / unbalance"
Oil filter	1 year	3000 hrs Change
Oil valve	Tightness check 1 year	Replacement in case of leakage

Component replacement intervals

Components	Service life – Recommended replacement	Service life – Recommended replacement Operating cycles
Control system	10 years	250 000 cycles
Pressure switch	10 years	250 000 cycles
Flame guard	10 years	250 000 cycles
UV flame sensor	10 000 hrs	N/A
Damper motor		500 000 cycles
Contaktor	10 years	500 000 cycles



The burner and its components must be recycled according to applicable regulations.

Delivery check

- Make sure everything is delivered and the goods have not been damaged during transit.
- If something is wrong with a delivery, report it to the supplier.
- Transport damage must be reported to the shipping company.

2. Technical data

The burner is intended for:

- Light oil, B10 heating oil/biofuel blend (as defined in DIN V51603-6)

and is used for:

- Water heating generators.
- Hot air generators (these require LMO 24 255 C2E).

2.1 Dimensions ST 133

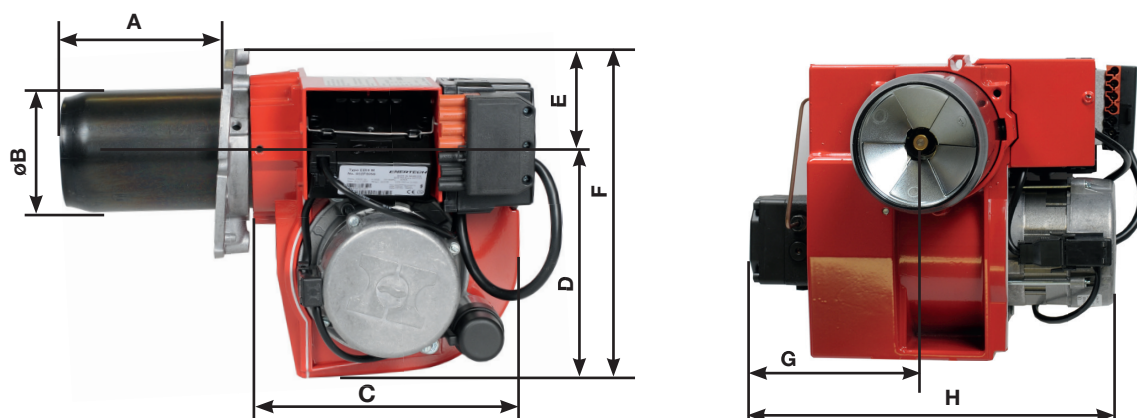

* Min. recommended distance to floor.

	Ø B	C	D	E	F	G	H	*I
ST 133	89	237	202	54	258	158	295	200

2.1.1 Dimensions, flanges

Length of blast tube	Flange 1 Measurement A	Flange 2 Measurement a
147	132	112
224	208.5	192.5

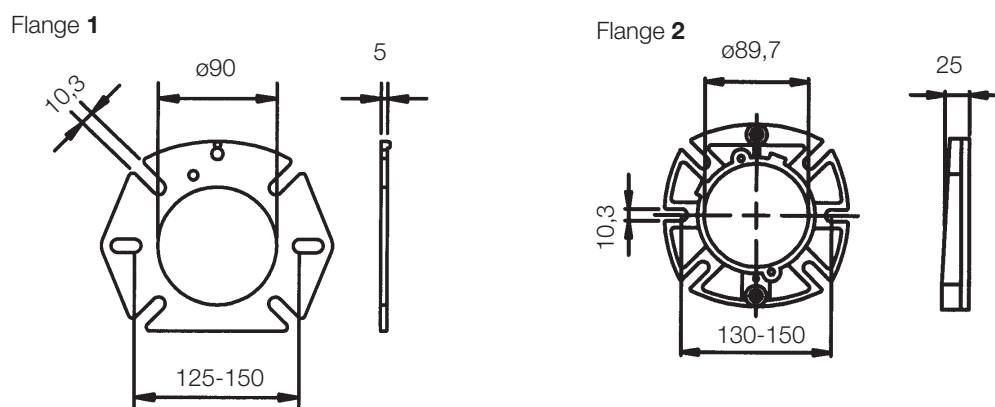

165 305 15-2

2.2 Burner installation

2.2.1 Hole patten

Make sure the hole pattern on the boiler is designed for burner flange.

Combustion device	d_1	d_2	d_3
ST 133	$\varnothing 90$	M10	$\varnothing 125-150$

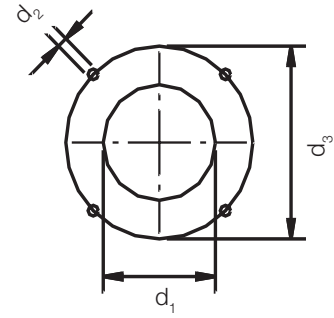

2.3 Working field ST 133 S, SV

3.0-7.5 kg/h
36-90 kW

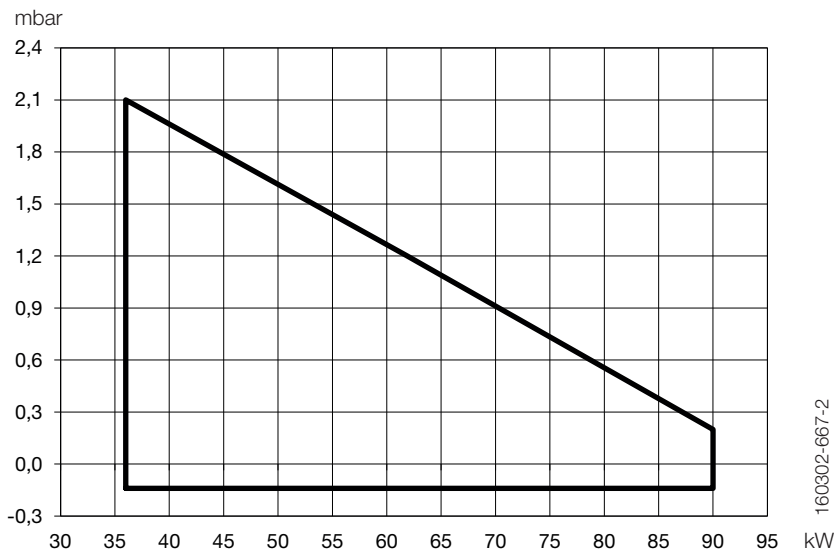

2.4 Electric Specification

Burner correspond to IP 20

Type	Motor	Complete burner	Sound
ST 133 S	125W 0,95A 230V 50/60Hz 4 μ F	230V 1,3A 50Hz	74 dBA \pm 0,5 dBA
ST 133 SV	125W 0,95A 230V 50/60Hz 4 μ F	230V 1,3A 50Hz	74 dBA \pm 0,5 dBA

Max operating current, see data plate.

2.5 Setting of brake plate and air flow

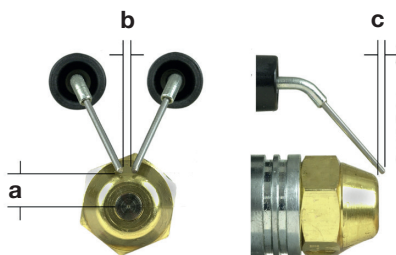

	a	b	c
ST 133	6,0-7,0	1,8-2,2	1,2-1,6

! *NB It is important that the spark does not strike against the brake plate or nozzle.

2.6 Recommended nozzles and pressures

Because of the different types of boiler in existence, with varying furnace geometries and furnace loads, it is not possible to commit to any given spray angle or spray pattern. Note that spray angles and spray patterns change with pump pressures.

Nozzle	60° Solid/Hollow cone 80° Solid/Hollow cone
Pump pressure	10 bar (8–14 bar) Fuel oil 1 10 bar (7–12 bar) Kerosene

2.7 Nozzle table, 8-15 bar

Gph	Pump pressure, bar															
	8		9		10		11		12		13		14		15	
	kg/h	kW	kg/h	kW	kg/h	kW	kg/h	kW	kg/h	kW	kg/h	kW	kg/h	kW	kg/h	kW
0,40	1,33	16	1,41	17	1,49	18	1,56	18	1,63	19	1,70	20	1,76	21	1,82	21
0,50	1,66	20	1,76	21	1,86	22	1,95	23	2,04	24	2,12	25	2,20	26	2,28	27
0,60	2,00	24	2,12	25	2,23	26	2,34	28	2,45	29	2,55	30	2,64	31	2,73	32
0,65	2,16	26	2,29	27	2,42	29	2,54	30	2,65	31	2,75	33	2,86	34	2,96	35
0,75	2,49	29	2,65	31	2,79	33	2,93	35	3,08	36	3,18	38	3,30	39	3,42	40
0,85	2,83	33	3,00	36	3,16	37	3,32	39	3,47	41	3,61	43	3,74	44	3,87	46
1,00	3,33	39	3,53	42	3,72	44	3,90	46	4,08	48	4,24	50	4,40	52	4,56	54
1,10	3,66	43	3,88	46	4,09	48	4,29	51	4,48	53	4,67	55	4,84	57	5,01	59
1,20	3,99	47	4,24	50	4,47	53	4,68	55	4,89	58	5,09	60	5,29	63	5,47	65
1,25	4,16	49	4,40	52	4,65	55	4,88	58	5,10	60	5,30	63	5,51	65	5,70	68
1,35	4,49	53	4,76	56	5,02	59	5,27	62	5,50	65	5,73	68	5,95	70	6,15	73
1,50	4,98	59	5,29	63	5,58	66	5,85	69	6,11	72	6,36	75	6,60	78	6,83	81
1,65	5,49	65	5,82	69	6,14	73	6,44	76	6,73	80	7,00	83	7,27	86	7,52	89
1,75	5,82	69	6,18	73	6,51	77	6,83	81	7,14	85	7,42	88	7,71	91	7,97	94
2,00	6,65	79	7,06	84	7,45	88	7,81	93	8,18	97	8,49	101	8,81	104	9,12	108
2,25	7,49	89	7,94	94	8,38	99	8,78	104	9,18	109	9,55	113	9,91	117	10,26	122

The table applies to oils with a viscosity of 4.4 mm²/s (cSt) at a density of 830 kg/m³.

2.7.1 Burner with preheater

Allow for a reduction in oil quantity of 5–20% with preheating owing to:

- Temperature increases at the nozzle.
- Nozzle design.
- Capacity (the higher the capacity the lower the difference).

2.8 Description

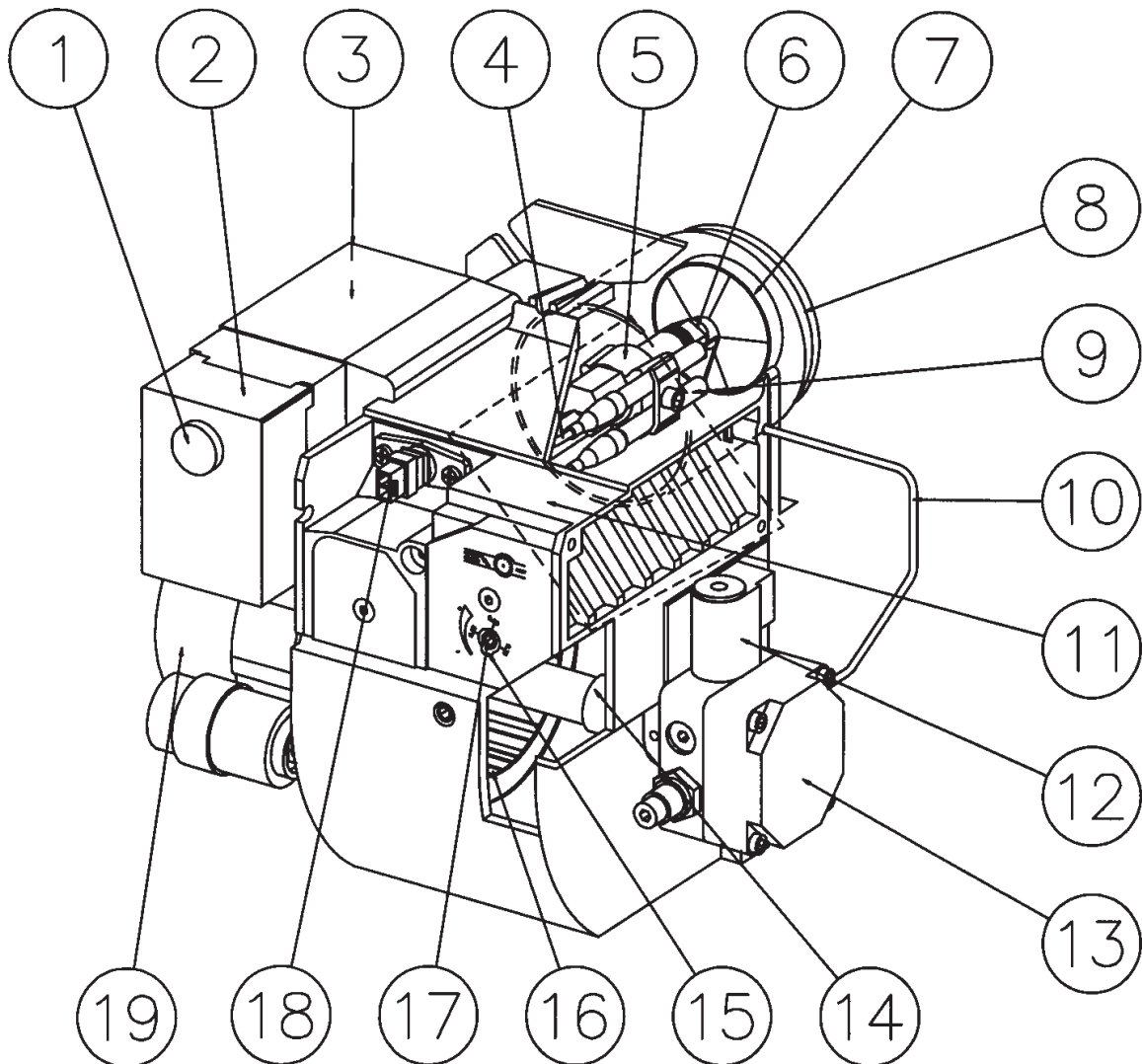

- | | | |
|-------------------------|------------------------|----------------------------|
| 1. Reset button | 8. Blast tube | 15. Indication, air damper |
| 2. Control box | 9. Ignition electrodes | 16. Fan wheel |
| 3. Ignition transformer | 10. Connecting pipe | 17. Adjustment, air damper |
| 4. Ignition cables | 11. Air damper | 18. Photoresistor |
| 5. Nozzle assembly | 12. Solenoid valve | 19. Motor |
| 6. Nozzle | 13. Pump | |
| 7. Brake plate | 14. Drive coupling | |

3. General instructions

3.1 General instructions

Oil burners must be installed in accordance with local regulations. The installer must therefore be knowledgeable of the regulations pertaining to oil and combustion.

Only oil suitable for the burner must be used and then in combination with a suitable oil filter installed before the burner's oil pump.

If the burner is replacing an existing burner, ensure that the oil filter is replaced or cleaned. Installation may only be performed by qualified personnel.

Care should be taken by the installer to ensure that electrical cables and oil lines are not pinched or otherwise damaged during installation or servicing

3.1.1 Installation and Maintenance Manual

The maintenance instructions supplied with the burner must be kept at an easily accessible location in the boiler room.

3.1.2 Instructions

The user must be comprehensively instructed in the operation of the oil burner and entire system. It is the responsibility of the supplier to instruct the user.

3.1.3 Inspection and maintenance

Refer to servicing schedule

3.1.4 Start-up

In order to obtain the correct setting, a flue gas analysis and temperature measurement must be carried out. Otherwise, there is a risk of soot build up, poor efficiency or condensation in the chimney. The system must be fine-tuned at start-up. The temperature in the chimney at a depth of 0.5 m must be at least 60 °C to prevent condensation.

3.2 Delivery inspection

Make sure everything is delivered and the goods have not been damaged during transit. If something is wrong with a delivery, report it to the supplier. Transport damage must be reported to the shipping company.

3.3 Preparing for installation

Check that the burner's dimensions and capacity range are suitable for the relevant boiler. The power data on the rating plate refers to the burner's minimum and maximum power.

3.4 Oil distribution

In order to achieve good reliability, it is important that the oil distribution system is designed correctly.

Take the following into account:

- Selection of pipe diameter, pipe length and height difference; see Pump instruction.
- Pipelines are to be laid with the fewest possible number of glands.
- The pipes are to be laid so that the oil supply hoses are not subjected to tensile stresses or become excessively bent when the burner is swung out or removed for servicing.
- The oil filter should be installed so that the filter cartridge can easily be replaced or cleaned.
- Parts in contact with oil must be selected in materials that are capable of withstanding the medium's physical properties.
- When installing oil hoses, check that the inlet and return hoses are fitted to the appropriate connection on the oil pump. The hoses must be located so that they do not bend or become subject to tensile load.
- Bleed the oil system. The oil pump/oil preheater may be damaged if run dry. The vacuum in the suction line should not fall below 0.3 bar during start-up.

 The oil filter must be installed before the burner's oil pump

 Be sure to fill the burner oil system before starting it for the first time.

3.5 Electrical connection

- Before work on the electrical connection, the current must be disconnected so that the installation is isolated.
- Electrical connection must be done in accordance with the applicable regulations.
- Burners must be connected to an all-pole switch.
- Connection must conform to the wiring diagram.
- Use appropriately sized fuses.



If any electrical connection is used other than that recommended by Enertech, there may be a risk of damage to property and personal injury.

3.6 Burner installation

3.6.1 Hole pattern

Make sure the hole pattern on the burner corresponds to the supplied flange (refer to Technical data).

3.6.2 Burner installation

1. Install the flange with gasket on the boiler.
2. Fit the selected nozzle (refer to Technical data).
3. Install the brake plate and check the ignition electrodes (refer to Burner Servicing).
4. Mount the burner to the flange.
5. Insulate between the burner and boiler door to reduce radiated heat (if necessary).

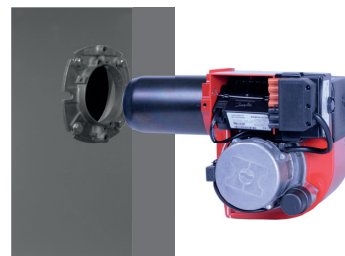

3.6.3 Oil lines

1. Check the dimensions of the oil lines (refer to Pump instructions).
2. The oil filter should be fitted to the incoming oil line. If a degasser is installed, the oil filter should be fitted to the oil line up to the degasser in order to prolong the service life of the oil filter.
3. For single pipe systems, the return plug must be removed (refer to Pump instructions).
4. When installing oil hoses, check that the supply and return hoses are fitted to the appropriate connection on the oil pump. The hoses must be located so that they do not bend or become subject to tensile load.
5. Bleed the oil system. Dry running will damage the oil pump.
6. The vacuum in the suction line should not fall below 0,3 bar during start-up.

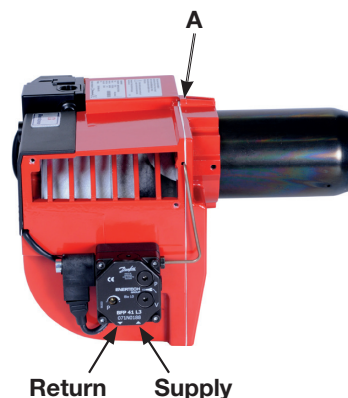

3.6.4 Electrical connection

If the boiler does not have a pre-fitted connector, connect to the supplied connectors (x2) as shown in the wiring diagram.

1. Switch off the main switch.
2. Connect the Europlugs (x2) as shown in the wiring diagram.
3. Fit the Europlugs (x2) to the burner.
4. Turn on the main switch.

3.6.5 Check oil line seals

Once the burner has been installed and commissioned, the seals of the various coupling elements should be checked.

When a leak is detected, it is usually sufficient to tighten the coupling element that is leaking.



165 205 20

4. Basic settings

4.1 Example of basic settings

4.1.1 Choice of nozzle

ST 133 S 75-24

Burner output	70 kW	
Estimated nozzle output:	$70 / 11.86^*$	= 5,90 kg/h

Choice of nozzle according to the table (refer to Technical data).
According to the nozzle table, this provides the following nozzle.

Nozzle:	1,50 GPH	
Pump pressure:	11.0 bar	

ST 133 SV 75-24

Burner output	70 kW	
---------------	-------	--

Output calculation due to preheater for nozzle choice according to the table (refer to Technical data).

Estimated nozzle output:	70×1.06	= 74,2 kW
	$74,2 / 11.86^*$	= 6,25 kg/h

Choice of nozzle according to the table (refer to Technical data).
According to the nozzle table, this results in the following nozzle.

Nozzle:	1,65 GPH	
Pump pressure:	10,5 bar	

4.1.2 Basic settings

The setting value for 70 kW according to basic settings tables (Setting values).

Air setting	=	12.0
Nozzle assembly setting	=	7.0

* Energy value of EO1 fuel oil = 11.86 kWh/kg

Setting values for nozzle and air damper

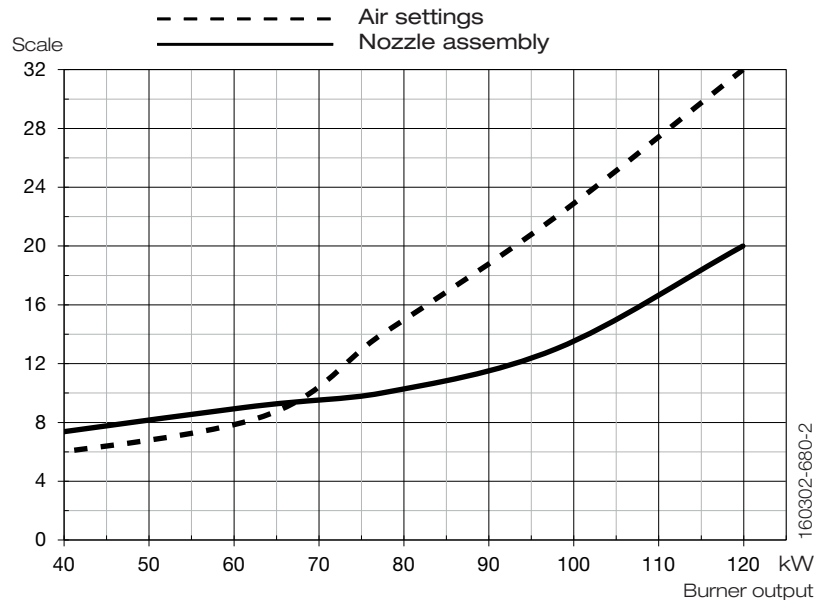

4.1.3 Nozzle assembly control

The burner is equipped with a lever that changes the position of the brake plate in the burner tube. This is used to set the correct pressure drop across the combustion assembly, thereby obtaining good combustion without pulsation.

The setting to be used depends on, among other things, the output settings and overpressure in the boiler

Setting the brake plate

- Small column: turn the screw left
- Large column: turn the screw right

Setting the brake plate position affects airflow. Therefore, it is always necessary to fine-tune airflow using the burner's airflow regulator.

4.1.4 Air intake adjustment

Setting the air intake is very important to achieve good combustion with neither too much nor too little air. To adjust the combustion airflow, turn the airflow regulator lever using an Allen key. The extent to which the airflow lever must be open is determined by the heat output and overpressure in the boiler as well as other settings on the burner such as the position of the brake plate.

4.1.5 Setting the air quantity

Turn the air intake clockwise to increase airflow and anticlockwise to decrease airflow.

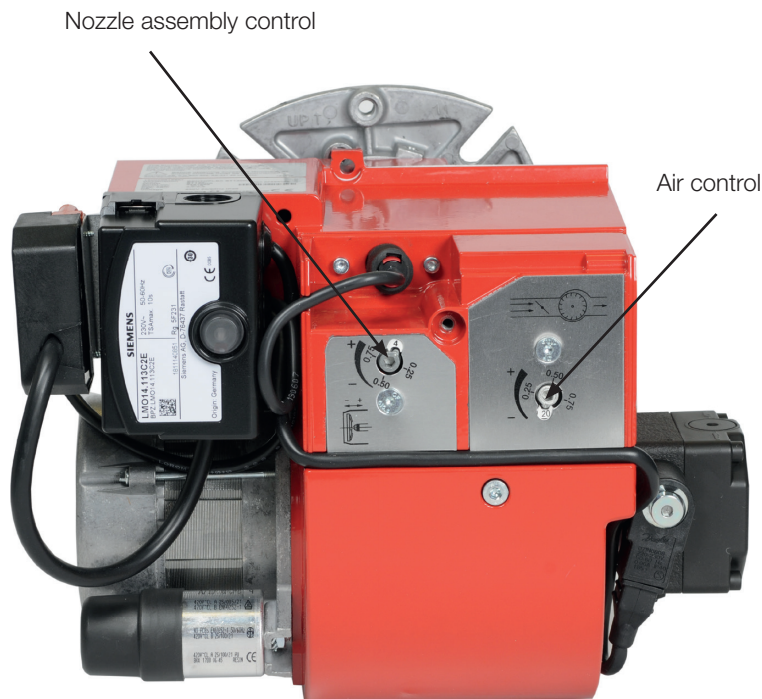

5. Burner servicing

5.1 Servicing

Servicing must be carried out after 3,000 operating hours, but at least once yearly.

Only authorised personnel may perform service.

Before any type of servicing is carried out, shut off the power at the main switch and turn off the oil.

Be careful: certain parts exposed after separation of the burner can be hotter than 60 °C. Care should be taken by the installer to ensure that electrical cables and oil lines are not pinched or otherwise damaged during installation or servicing.

5.2 Servicing the combustion device

1. Switch off mains power and disconnect the Europlug from the burner.
2. Remove the burner from the boiler by loosening the screw (A)
3. Loosen the housing screw (B) and remove the front cover (C).
4. Visually inspect the combustion assembly and check the various components for defects.
5. Loosen and pull off the brake plate/package from the oil pipe. Clean the brake plate as necessary.
6. Unscrew the nozzle.
7. Fit the nozzle. Do not clean the nozzle. If the nozzle is defective, it must be cleaned.
8. Check the ignition electrodes. Replace as necessary (refer to Technical data for electrode settings).
9. Install the brake plate and electrode package (see Fig. 1.2). Check that the distance between the nozzle and brake plate is correct (refer to Technical data).
10. Fit the front cover and insert the burner into the boiler.
11. Connect the Europlug and turn on the mains power.
12. Start the burner and check the combustion.

1



2

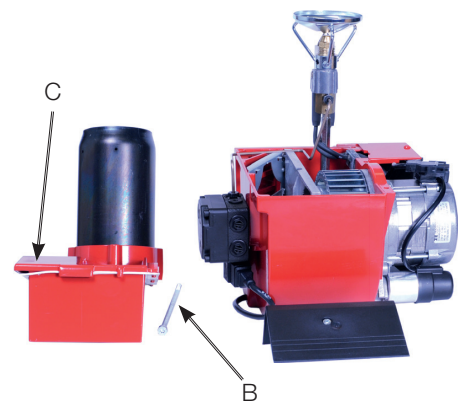
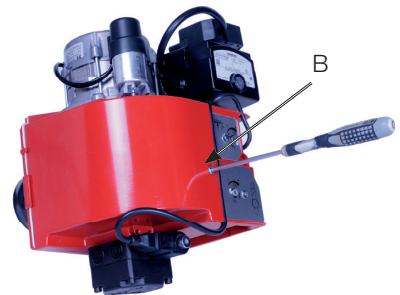

When servicing/replacing components that affect combustion, an analysis and soot test must be carried out on the installation.

5.2.1 Replacing the preheater

1. Switch off mains power, remove the cover and disconnect the Europlug from the burner.
2. Remove the burner from the boiler by loosening the screw (A)
3. Loosen the housing screw (B) and remove the front cover (C).
4. Remove the preheating and ignition cables.
5. Loosen and pull the brake disc off the preheater. Clean the brake plate as necessary.
6. Unscrew the nozzle.
7. Loosen the nut holding the oil pipe and preheater together.
8. Install the new preheater. Check the condition of the O-ring, replace if necessary.
9. Fit the nozzle. Do not clean the nozzle. If the nozzle is defective, it must be cleaned.
10. Fit the brake plate/electrode package. Check that the distance between the nozzle and brake plate is correct (refer to Technical data).
11. Connect the preheating and ignition cables.
12. Fit the front cover and insert the burner into the boiler.
13. Connect the Europlug and turn on the mains power.
14. Start the burner and check the combustion.



When servicing/replacing components that affect combustion, an analysis and soot test must be carried out on the installation.

5.3 Replacing the oil pump

1. Switch off mains power and disconnect the Europlug from the burner.
2. Undo the oil hoses from the pump.
3. Remove the burner from the boiler by loosening the screw (A)
4. Loosen the housing screw (B) and remove the front cover (C). This will make it easier to install the pump.
5. Disconnect the solenoid valve cable from the pump.
6. Disconnect the connection tube (D) from the pump.
7. Loosen the screws (E) and pull out the oil pump.
8. Install the new oil pump on the burner. Tighten the screws and fit the connection tube (D). (It is important that the pump shaft splines align correctly in the pump coupling).
9. Fit the front cover and insert the burner into the boiler.
10. Fit the oil hoses (for conversion between single-pipe and double-pipe systems, see Pump instructions).
11. Connect the Europlug and turn on the mains power.
12. Turn on the burner, air the pump, adjust the pressure, and check the combustion.

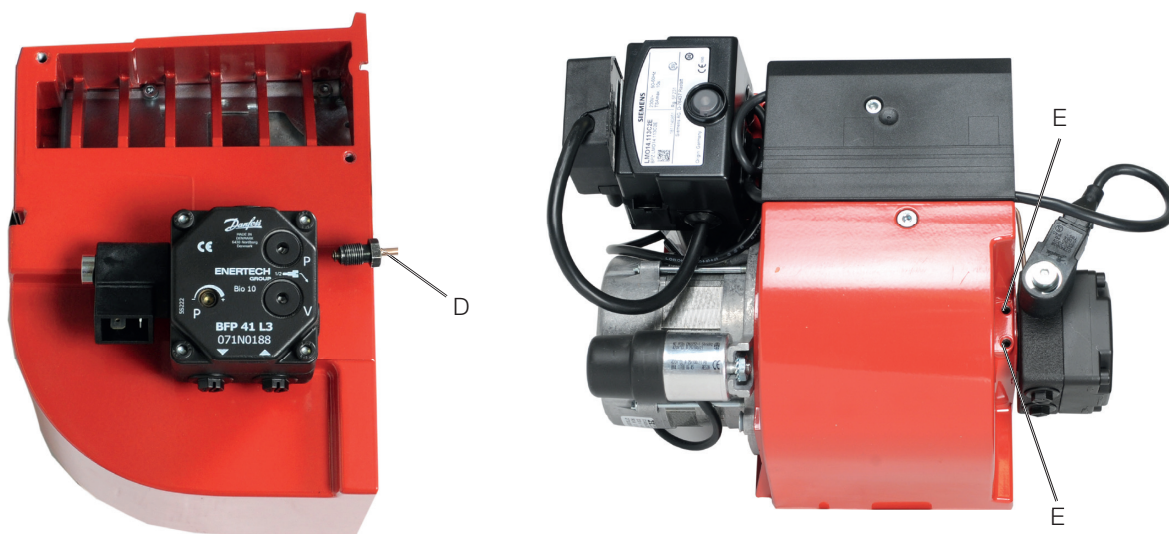

When servicing/replacing components that affect combustion, an analysis and soot test must be carried out on the installation.

5.4 Replacing the fan motor and fan wheel

1. Switch off mains power and disconnect the Europlug from the burner.
2. Remove the burner from the boiler by loosening the screw (A).
3. Loosen the housing screw (B) and remove the front cover (C). This will make it easier to fit the motor and fan wheel.
4. Disconnect the electrical connector to the motor.
5. Loosen the spring (G) holding the transformer.
6. Loosen the screws (F) (x2) holding the motor flange.
7. Lift out the motor.
8. Remove the end of the drive coupling from the motor axle, loosen and remove the fan wheel.
9. Fit the fan wheel to the motor, tighten the locking screw. The fan wheel must be fitted with a little play between the motor and the fan wheel. Make sure that there are no scratching noises. Refit the end of the drive coupling.
10. Align the motor flange with the fan housing. Make sure the drive coupling has not fallen out and that it is correctly inserted in the end of the drive coupling on the motor and pump. Also ensure that no cables are pinched.
11. Re-assemble the motor and fan housing. Alternately tighten the screws. This is done to ensure the fan housing and the motor flange are aligned in the correct position.
12. Connect the motor cable.
13. Refit the spring (G) holding the transformer.
14. Assemble the fan housing and front cover and insert the burner into the boiler.
15. Connect the Europlug and turn on the mains power.
16. Start the burner and check the combustion.

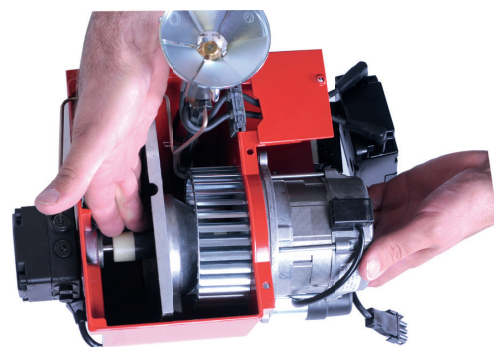
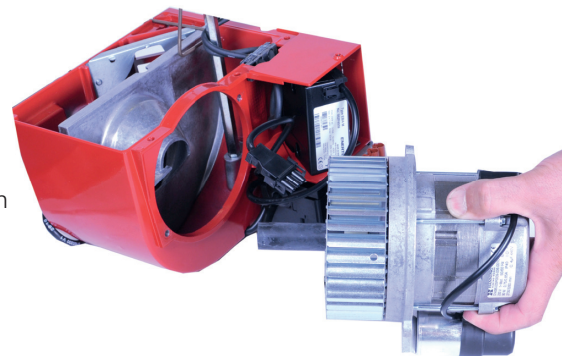
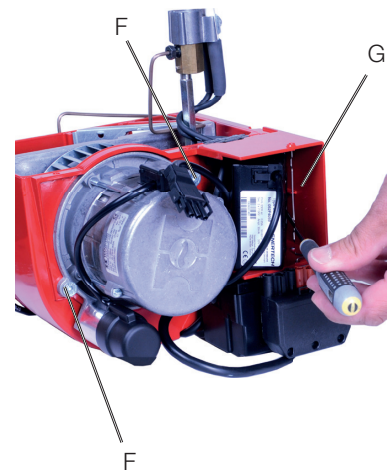

When servicing/replacing components that affect combustion, an analysis and soot test must be carried out on the installation.

5.5 Servicing the air intake and intake cone

1. Switch off mains power and disconnect the Europlug from the burner.
2. Remove the burner from the boiler by loosening the screw (A).
3. Loosen the housing screw (B) and remove the front cover (C).
4. Loosen the motor and oil pipes.
5. Remove the air intake.
6. Check the functionality and appearance of the various components in the air regulator. Clean and replace components as necessary.
7. Assemble the burner. Make sure to refit in the same position as before disassembly.
8. Insert the burner into the boiler and connect the Europlug.
9. Switch on mains power, start the burner and check the combustion.

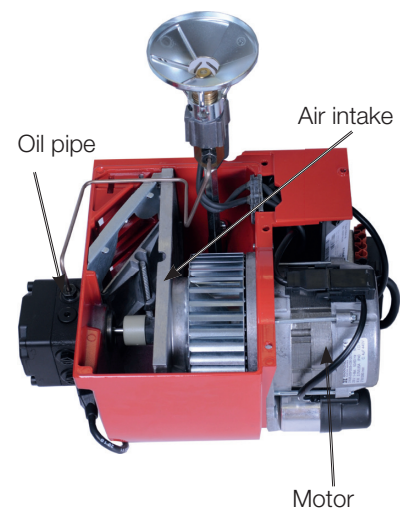

5.6 Replacing the entire electrical package

1. Switch off mains power and disconnect the Europlug from the burner.
2. Remove the burner from the boiler by loosening the screw (A).
3. Remove the cover.
4. Disconnect the electrical connector to the motor.
5. Disconnect the electrical connector to the transformer.
6. Disconnect the electrical connector to the pump.
7. Remove the photoresistor.
8. Remove the burner control and loosen the two bottom screws in the relay socket.
9. The Europlug plate is firmly attached under the relay socket.
10. Fit the new electrical package (do not forget the Europlug).
11. Refit the photoresistor.
12. Connect the motor cable, transformer cable and pump cable.
13. Turn on the burner control.
14. Refit the cover.
15. Connect the Europlug and turn on the mains power.
16. Start the burner and check the combustion.

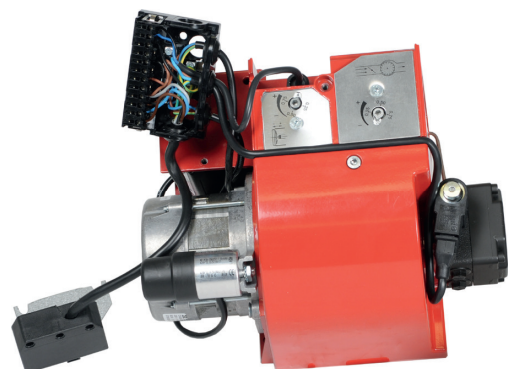

When servicing/replacing components that affect combustion, an analysis and soot test must be carried out on the installation.

5.7 Replacing individual electrical package components

1. Switch off mains power and disconnect the Europlug from the burner.
2. Remove the burner from the boiler by loosening the screw (A).
3. Remove the burner control and loosen the two bottom screws in the relay socket.
4. The Europlug plate is firmly attached under the relay socket.
5. Remove the cable of the component to be replaced.
6. Connect the new cable.
7. Refit the electrical package (do not forget the Europlug).
8. Turn on the burner control.
9. Connect the Europlug and turn on the mains power.
10. Start the burner and check the combustion.



When servicing/replacing components that affect combustion, an analysis and soot test must be carried out on the installation.

6. Instructions Pump

6.1 SUNTEC AS

Technical data AS47CK

One or two-pipe system.

Viscosity range:	1-12 mm ² /s	
Pressure range:	7-14 bar	
Rated voltage of coil:	220/240V	50/60 Hz
Oil temperature:	max 60°C	

Technical data AS67C

One or two-pipe system.

Viscosity range:	1-12 mm ² /s	
Pressure range:	10-15 bar	
Rated voltage of coil:	220/240V	50/60 Hz
Oil temperature:	max 60°C	

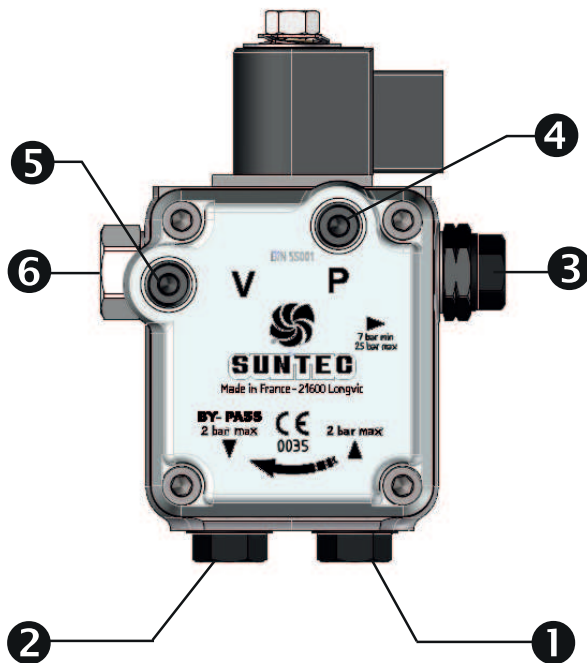

Components

1. Suction line G 1/4"
2. Return line G 1/4" and internal by-pass plug
3. Nozzle outlet G 1/8"
4. Pressure gauge port G 1/8"
5. Vacuum gauge port G 1/8"
6. Pressure adjustment

Applications for SUNTEC AS

The SUNTEC AS oil pump has a built in solenoid valve which controls the regulator cut-off valve giving fast cut-off and cut-on function independent of the rotational speed.

Applications

Light oil, B10 heating oil/biofuel blend (as defined in DIN V51603-6) and kerosene.

- One or two-pipe system.

Pump operating principle

The gear set draws oil from the tank through the built-in filter and transfers it to the valve that regulates the oil pressure to the nozzle line. All oil that does not go through the nozzle line will be dumped through the valve back to the return line in two pipe installation or, if it is a one-pipe installation, back to suction port in the gear set.

In that case, the by-pass plug must be removed from the return port, and the return port sealed by steel plug and washer.

The solenoid valve of the AS pump is of the "normally opened" type.

When the solenoid valve is non-activated, the by-pass channel between the pressure and return sides of the valve is open. No pressure will then be built up to open the valve; it does not matter which speed the gear set has.

When the solenoid is activated, this by-pass channel is closed and because of the full speed of the gear set, the pressure necessary to open the valve will be built up very rapidly, which gives a very sharp cut-on function.

Cut-off

When the burner stops, the solenoid opens the by-pass at the same moment, which drains all the oil down to the return, and the nozzle valve closes immediately.

This gives a very sharp cut-off function. The cut-on and cut-off can be actuated regardless of motor speed and have an extremely fast response.

When the solenoid is not activated, the torque requirement is low up to full motor speed.

Bleeding

Bleeding of pumps with two-pipe systems takes place automatically, but bleeding can be accelerated by opening a pressure port.

On pumps with a single-pipe system, a pressure port must be opened to empty the system of air.

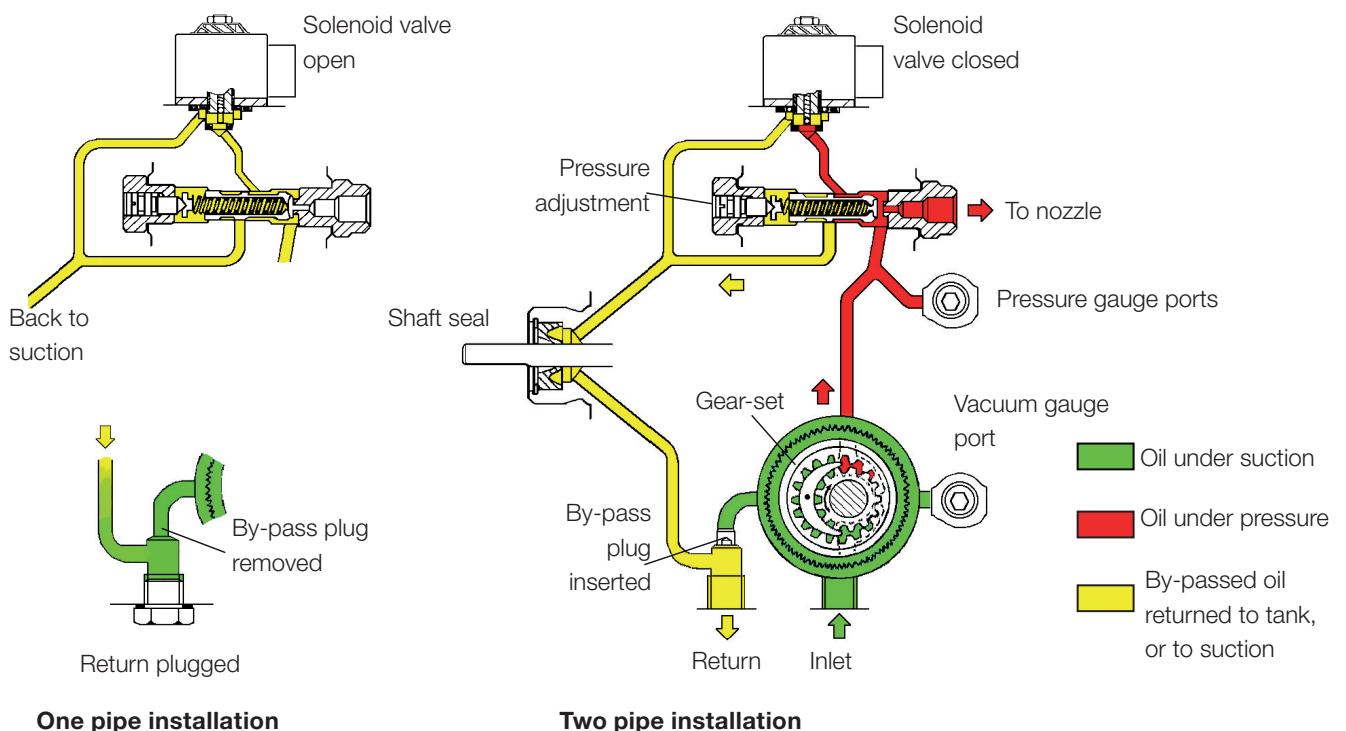

165 105 20 2020-11-03/2

6.1.1 Suction line tables

6.1.1.1 Overlying tank

1-pipe system

Nozzle*/Düse* Gicleur*/Ugello* (US GPH)	0,50		0,60		0,80		1,00		1,50		2,00		4,00			6,00			9,50			
d (mm)	4	4	4	4	4	6	4	6	4	6	8	4	6	8	4	6	8	4	6	8	10	
H (m)																						
0	90	75	56	45	30	150	22	113	11	56	150	7	37	119	4	23	74	150				
0,5	100	83	63	50	33	150	25	126	12	63	150	8	41	133	4	26	83	150				
1	110	92	69	55	37	150	27	139	13	69	150	8	46	146	5	28	92	150				
2	131	109	82	65	44	150	33	166	16	82	150	10	55	150	6	34	109	150				
3	152	126	95	76	50	150	38	192	18	96	150	12	63	150	7	39	127	150				
4	172	144	108	86	57	150	43	218	21	109	150	14	72	150	8	45	144	150				

*A2L pumps : sum up the 2 nozzles / A2L-Pumpen : Summe der zwei Düsen
pompe A2L : somme des 2 gicleurs / Perle pompe A2L agglungere n.2 ugelli

One pipe siphon feed system
Einstranginstallation - Tank höher als Pumpe
Installation monotubo en charge
Impianti monotubo a sifone

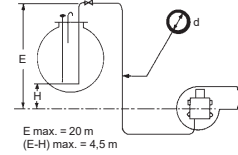

Two-pipe system

H (m)	d (mm)	Pump/Pumpe Pompe/Pompa Q** (l/h)				35/45				55				65				75				95			
		4	6	8	10	6	8	10	12	6	8	10	12	8	10	12	14	8	10	12	14				
0	2	15	50	124	11	38	96	150	7	27	71	150	20	54	116	150	16	46	100	150					
0,5	2	16	56	138	12	42	107	150	8	31	79	150	23	61	130	150	19	52	112	150					
1	2	18	61	150	13	47	118	150	9	34	88	150	26	68	144	150	21	57	124	150					
2	3	22	73	150	16	56	141	150	11	41	105	150	31	81	150	150	26	69	148	150					
3	4	26	85	150	19	66	150	150	13	48	122	150	36	94	150	150	31	81	150	150					
4	4	30	97	150	22	75	150	150	16	55	139	150	42	108	150	150	35	92	150	150					

**Q = pump capacity @ 0 bar / Pumpenleistung bei 0 bar
capacité de l'engrenage à 0 bar / portata della pompa a 0 bar.

Two pipe siphon feed system
Zweistranginstallation - Tank höher als Pumpe
Installation bitube en charge
Impianti bitubo a sifone

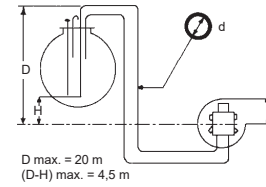

6.1.1.2 Underlying tank

1-pipe system

With an underlying tank a 1-pipe-system is not recommended

Two-pipe system

Pump/Pumpe Pompe/Pompa Q** (l/h)	35/45 60				55 77				65 102				75 130				95 150			
	d (mm)				d (mm)				d (mm)				d (mm)				d (mm)			
H (m)	6	8	10	12	6	8	10	12	6	8	10	12	8	10	12	14	8	10	12	14
0	15	50	124	150	11	38	96	150	7	27	71	150	20	54	116	150	16	46	100	150
0,5	13	44	109	150	9	33	84	150	6	24	62	132	17	48	103	150	14	40	88	150
1	11	38	95	150	8	29	73	150	4	20	54	115	15	41	89	150	12	34	76	144
2	7	26	66	138	5	19	51	107	2	13	37	80	9	28	61	116	7	23	52	100
3	3	14	37	79		10	28	60		6	20	44	4	14	33	65		11	28	55
4			8	19			5	14				9			6	14			4	11

Two pipe lift system
Zweistranginstallation - Tank tiefer als Pumpe
Installation bitube en aspiration
Impianti bitubo in aspirazione

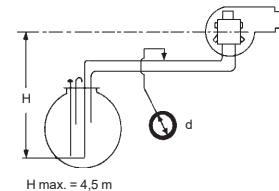

The suction line tables consist of theoretically calculated values where the pipe dimensions and oil velocity have been matched so that tur-bulences will not occur. Such tur-bulences will result in increased pressure losses and in acoustic noise in the pipe system. In addition to drawn copper piping a pipe system usually comprises 4 elbows, a non-return valve, a cut-off valve and an external oil filter.

The sum of these individual resi-stances is so insignificant that they can be disregarded. The tables do not include any lengths exceeding 100 m as experience shows that longer lengths are not needed.

The tables apply to a standard fuel oil of normal commercial quality according to current standards. On commis- sioning with an empty tube system the oil pump should not be run without oil for more than 5 min. (a condition is that the pump is being lubricated during operation).

The tables state the total suction line length in metres at a nozzle capacity of 9,5 Gph. Max. permissible pressure at the suction and pressure side is 2,0 bar.

6.1.2 Check oil line seals

Once the burner has been installed and commissioned, the seals of the various coupling elements should be checked (A).

When a leak is detected, it is usually sufficient to tighten the coupling element that is leaking.



Use caution when operating the burner, surfaces may be hot.



When servicing oil bearing components, check for oil leakage when the burner is commissioned after servicing.

6.1.3 Replacement of pump filter

Removal and installation

1. Close the oil supply to the burner.
2. Loosen the pump cover's screws.
3. Remove the filter and gasket.
4. Mount new gasket and filter.
5. Refit the cover.
6. Open the oil supply.
7. Start the burner and check seals and combustion.

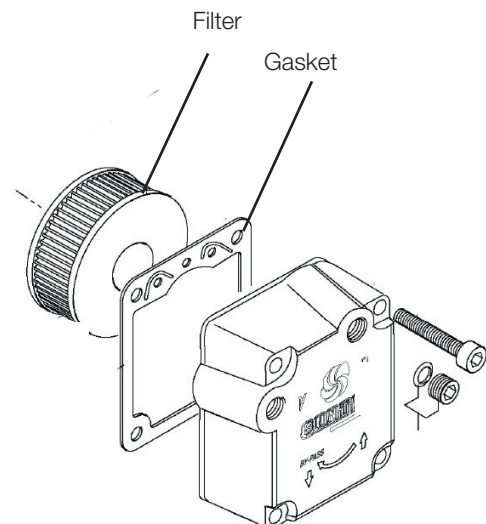

When servicing/replacing components that affect combustion, an analysis and soot test must be carried out on the installation.

6.1.4 Replacing the solenoid valve (pump)

Removal and installation

1. Make sure the power to the burner is switched off.



If the burner is directly connected, ensure that all components on the burner are without power.

2. Disconnect the solenoid valves' electrical cables.
3. Loosen the nut holding the magnet terminal.
4. Loosen the screws securing the valve's mounting plate.
5. Remove the valve.
6. Check to ensure the correct valve is in place.
7. Install the new valve and refit the other parts in the reverse order.
8. Check functionality.

6.1.5 Replacing the gasket seal (pump)

Removal and installation

1. Disconnect hoses, oil pipes, and electrical cables.
2. Loosen the pump (screw J).
3. Loosen the gasket seal's locking rings.
4. Remove the old gasket seal (2).
5. Install the new gasket seal.
6. Connect hoses, oil pipes, and electrical cables.
7. Test run and check seals.

Components Oil pump

1. Pressure regulator
2. Shaft seal kit (lip seal + protective cone)
3. By-pass plug
4. G 1/4 gasket
5. G 1/4 steel plug (1-pipe system)
6. Filter
7. Cover gasket
8. Cover
9. Pressure gauge port or vacuum gauge port screw, O-ring
10. Coil
11. Tube assy

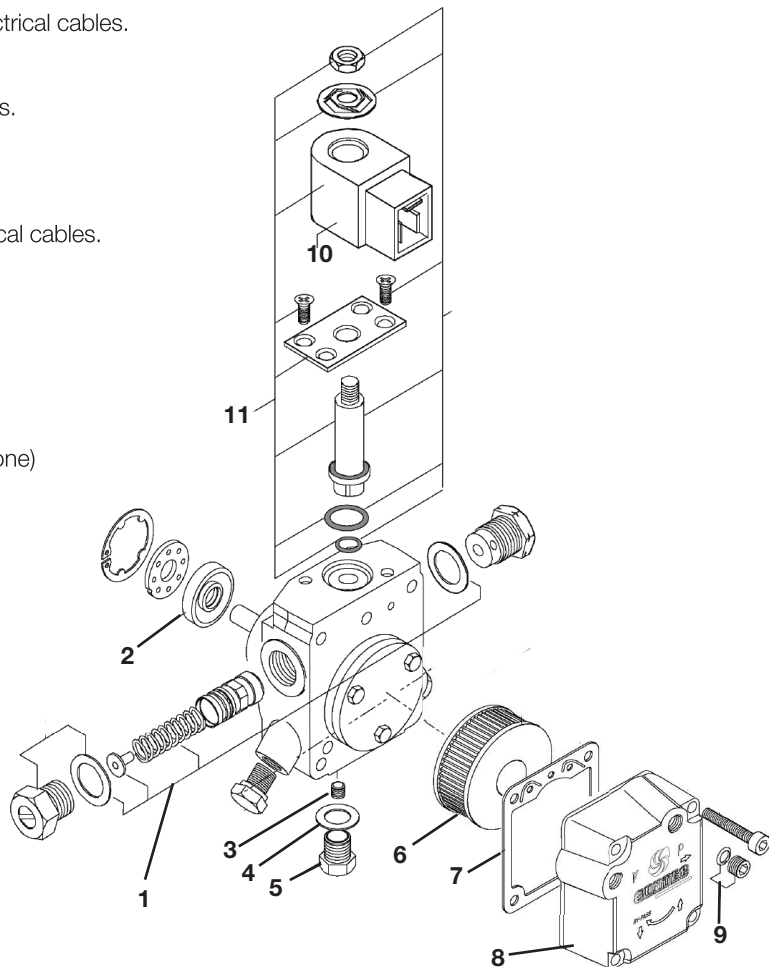

7. Oil burner control

7.1 Wiring diagram

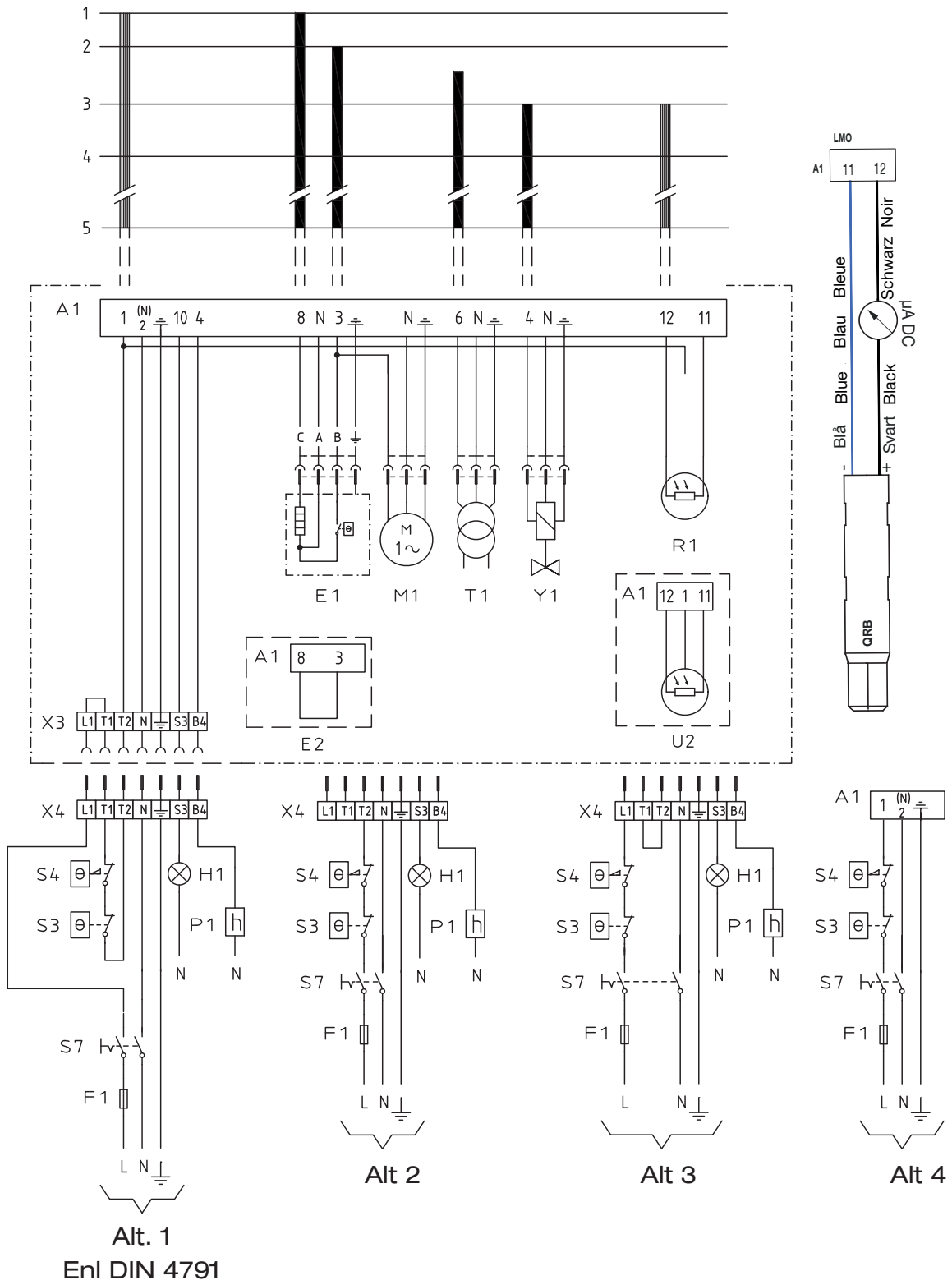

7.1.1 List of components

A1	Oil burner control	U2	UV-cell QRC
E1	Preheater	S3	Control thermostat
E2	Burner without preheater	S4	Temperature limiter
F1	Fuse max. 10 A	S7	Main switch
H1	Lamp, low capacity	T1	Ignition transformer
M1	Burner motor	Y1	Solenoid valve
P1	Time meter, low capacity (optinal)	X3	Plug-in contact, burner
R1	Flame detector QRB	X4	Plug-in contact, boiler

 Mains connection and fuse in accordance with local regulations.

Preheater cable color: A Blue B Brown C Black

7.1.2 Function LMO14/24

- 1 **Switch on operating switch and twin thermostat**
A spark is formed. The air damper motor opens the damper to low load position. The burner motor starts, the prepurge goes on till the prepurge period expires and the solenoid valve 1 opens (2).
2. **Solenoid valve 1 opens**
Oil mist is formed and ignited. The photocell indicates a flame. The ignition spark goes out after flame indication (See Technical data oil burner control).
3. **The safety time expires**
 - a If no flame is established before this time limit the control cuts out.
 - b If for some reasons the flame disappears after this time limit, the burner will make an attempt to re-start.
- 4 **High/Low thermostat ON**
The burner is in operating position and can now change between full load and low load.
- 4-5 **Operating position**
If the burner operation is interrupted by means of the main switch or the thermostat, a new start takes place when the conditions in accordance with point 1 are fulfilled.
The oil burner control cuts out
A red lamp in the control is lit. Press the reset button and the burner re-starts.

Technical data oil burner control	LMO14.113...	LMO24.255...
Pre-ignition time:	15 s	25 s
Pre-purge time:	16 s	26 s
Post-ignition time:	3 s	5 s
Safety lock-out time:	< 10 s	< 5 s
Reset time after lockout:	< 1 s	< 1 s
Reaction time on flame failure:	< 1 s	< 1 s
Ambient temperature:	-5 - +60°C	-20 - +60°C
Min. current with flame established:	45 µA dc	45 µA dc
Max. photo current at start:	5,5 µA dc	5,5 µA dc

7.2 Colour codes LMO14/24

When the burner starts, the light in the reset switch indicates the normal sequence, and also indicates whether something abnormal is happening as per the following table:

Preheater in operation	Solid yellow
Ignition switched on	Flashing yellow
Normal operation	Solid green
Operation, poor flame signal	Flashing green
Undervoltage	Flashing yellow-red
Fault, alarm	Solid red
False light	Flashing red-green
Communication mode	Fluttering red

7.3 Fault codes LMO14/24

When the red light for a blocked relay box comes on, you can get information about what has caused the problem by pressing and holding the reset button for 3 seconds.

The number of flashes below is repeated with a pause in between.

2 flashes	No flame signal when safety time expires
4 flashes	False light during start
7 flashes	3 x Losses of flame during operation
8 flashes	Time-out for preheater *
10 flashes	Incorrect wiring, internal fault or simultaneous occurrence of two faults

* In order for this fault code to occur, the preheater shall not reach its cut-off temperature within 10 mins. from switch on.

To return to normal operation: Press the reset button for 1 second.

If the reset button is instead kept pressed a second time for at least 3 seconds, you can, via an interface, obtain the corresponding information on a computer or flue gas analyser.

To return to normal operation: Press the reset button for 1 second.

8. Fault Location

8.1 Burner will not start

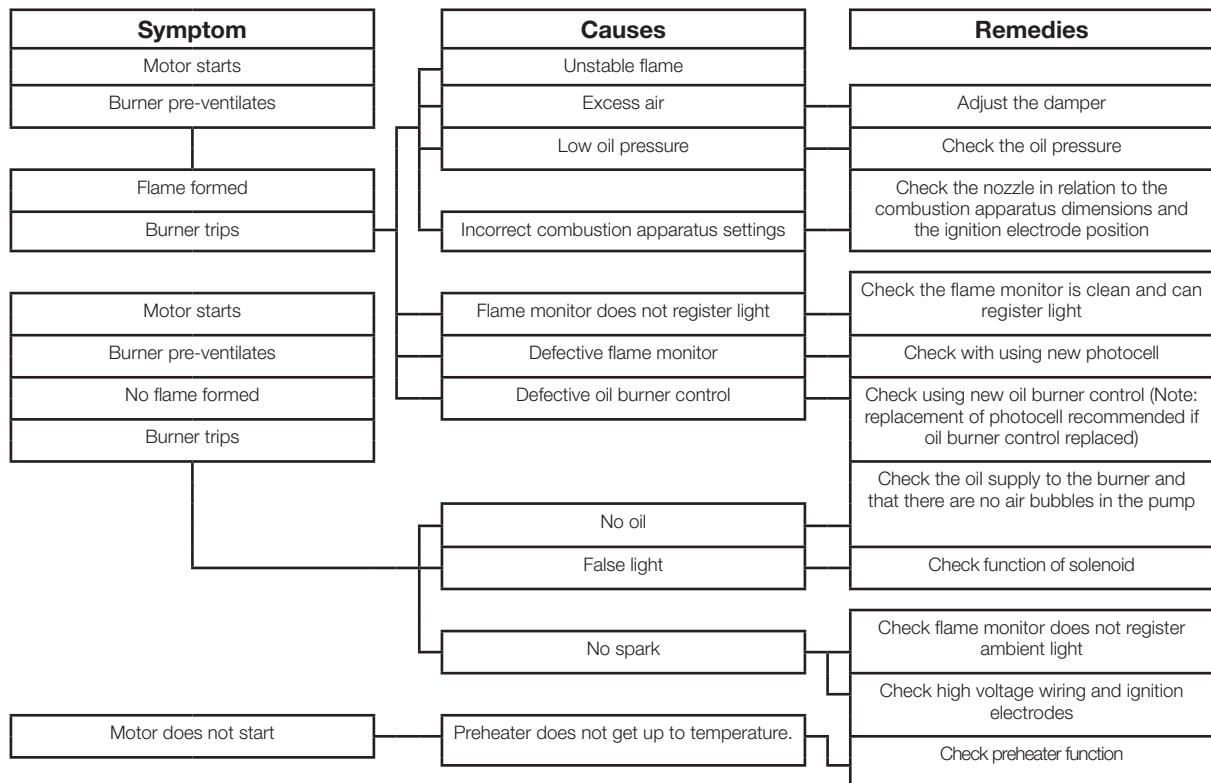

8.2 Burner will not start after normal use

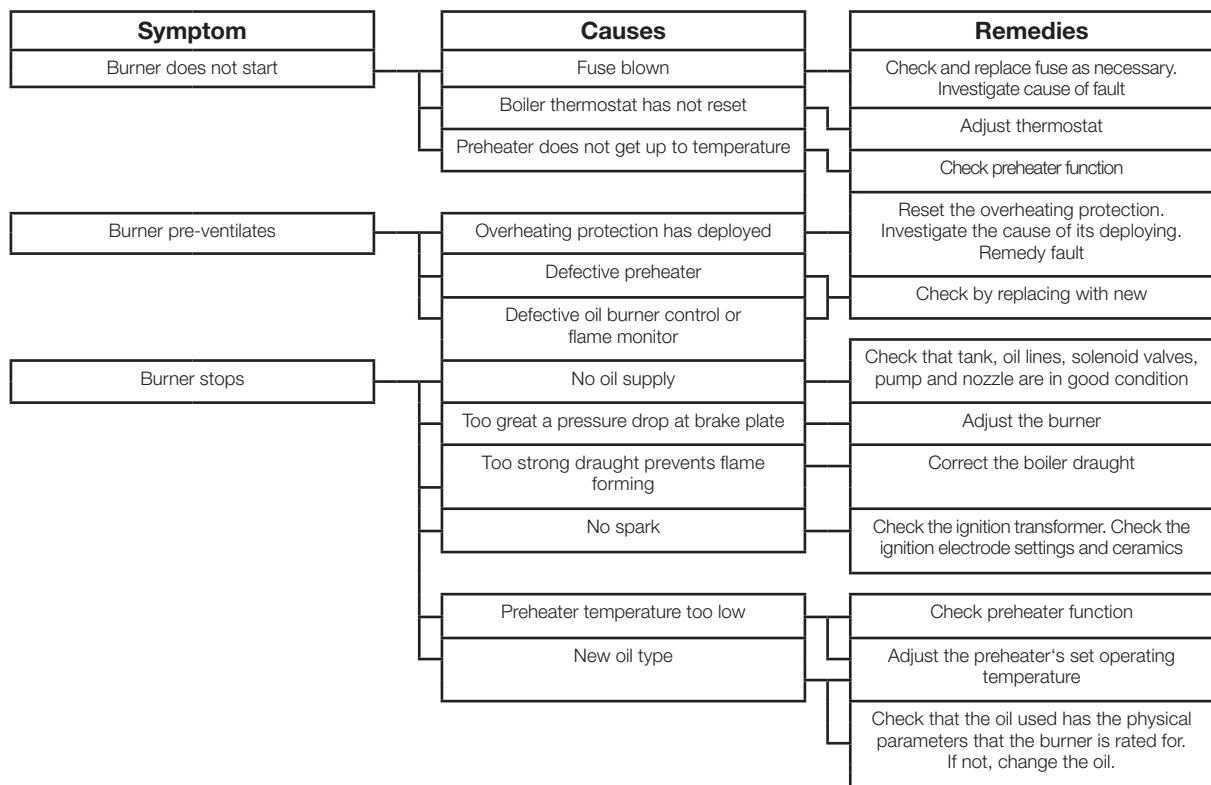

8.3 Delayed ignition

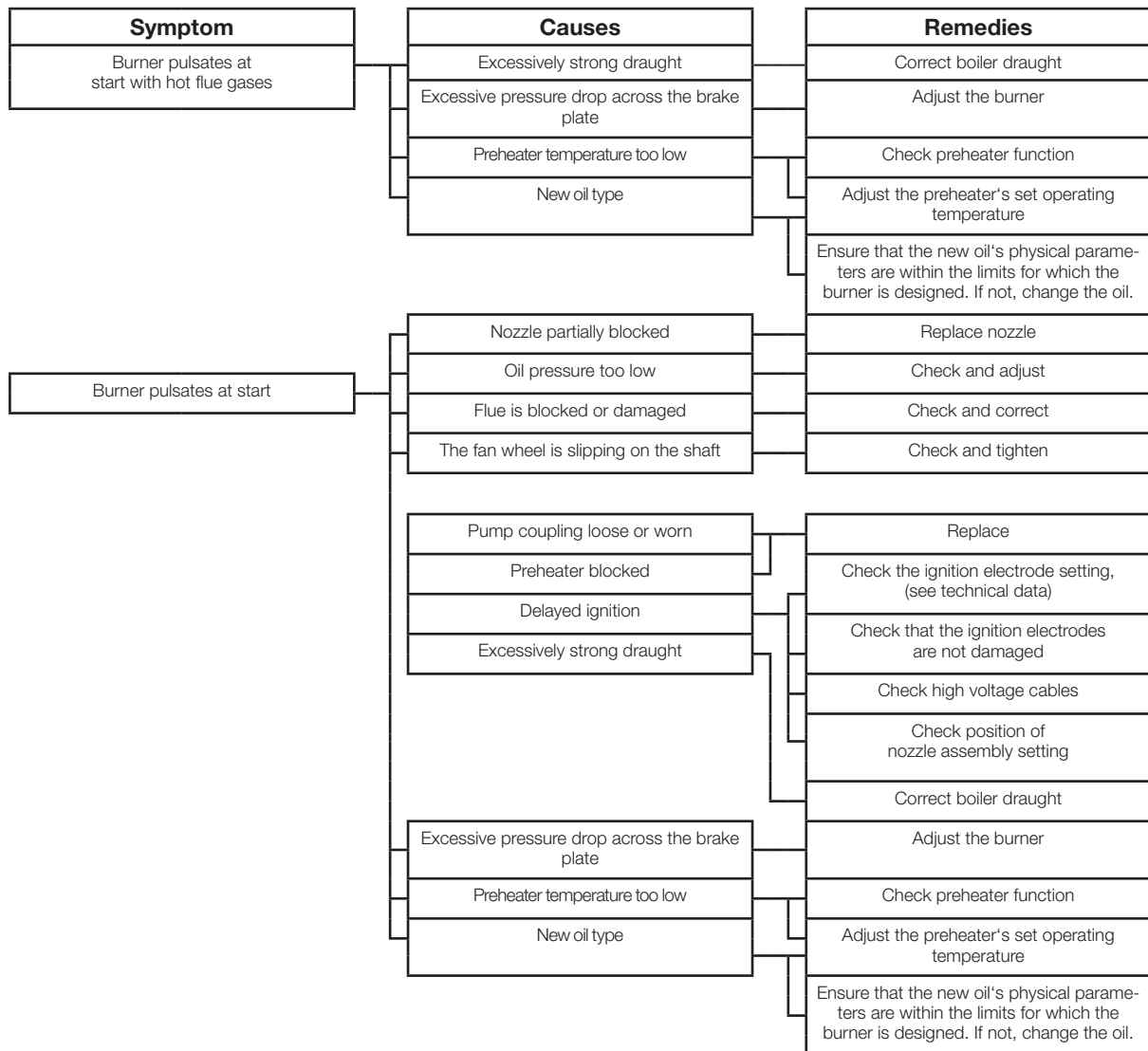

8.4 Noise in pump

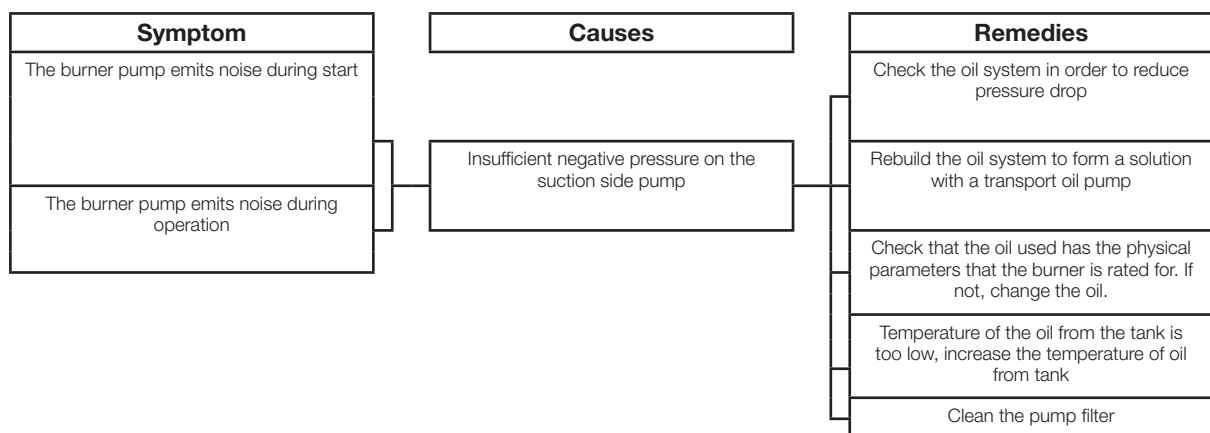

8.5 Pump pressure

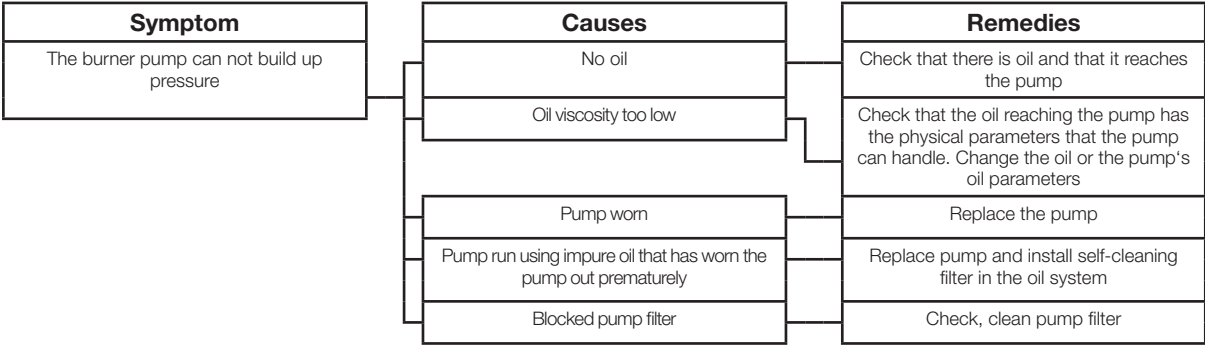

EU Declaration of conformity



Bentone Oil Burners

Type

BF 1	ST 146	B 45	B 80
ST 108	B 2	B 55	
ST 120	B 30	B 65	
ST 133	B 40	B 70	

This declaration of conformity is issued under the sole responsibility of the manufacturer. The object of the declaration described above is in conformity with:

Machinery Directive 2006/42/EC

EMC 2014/30/EU

Restriction of the use of certain hazardous substances (RoHS) Directive 2011/65/EU

References to the relevant harmonised standards used or references to the other technical specifications in relation to which conformity is declared:

EN 267:2009+A1:2011 Excluded Annex J/K. Automatic forced draught burners for liquid fuels.

Additional information can be downloaded at:

www.bentone.com

Enertech AB
Box 309
S-341 26 LJUNGBY

Ljungby, January 26th 2021

Helene Richmond

Managing Director

Enertech AB

9. Log of flue gas analysis

Owner	Adresss	Tel. no:
Installation		Tel. no:

Boiler

Type	Make	Power kW
------	------	----------

Bentone Burner

Type	Model	Serial no.	Fuel
------	-------	------------	------

	Step 1	Step 2	Step 3
Draught in fireplace			
Fan Press mbar			
Filter smoke number			
CO ₂			
O ₂			
NOx			
CO			
Flue gas temp. °C			
Setting brake disc			
Setting Air damper			
Pump pressure bar			
Nozzle			

Test performed / 20	Address
Test performed by:	Postal address
Company name:	Tel. no:

10. Oil burners maintenance instructions

General information

Keep the boiler room clean. Ensure that the boiler room has permanent fresh air intake. Switch off before dismantling the oil burner.

At hinged mounting, make sure that an automatic safety switch is fitted, so that the burner cannot start when the swing door is open.

Don't use the oil fired boiler to burn paper or rubbish, unless the boiler is especially fitted with a hinged door to make this possible.

Don't fill tank while burner is working.

Starting precautions

Make sure that the oil tank is not empty

Make sure that the valves on oil and water supply pipes are open.

Make sure that the boiler flue damper is open.

Make sure that the boiler thermostat is set at the correct temperature.

Switch on the current. Most relay systems have a delayed action so that the burner will not start for perhaps 20 seconds.

With heavy oil the delay will be longer as the burner will not start until the oil in the preheater reaches the required temperature.

If the burner will not start

Press the reset button on the relay. Check that the thermostats are correctly adjusted.

Don't forget the room thermostat, check that any fuses are intact and main switch is on.

If the burner starts but does not ignite

Make an attempt to start the burner.

Never make close repeated start attempts.

Don't restart the burner until the boiler is free from oil gases.

If the burner still does not ignite send for the service engineer.

When switching off during summer

Always use the main switch to cut out the burner even when adjusting the burner or cutting off the heating for a short time. For longer periods of shut down, close all valves and the oil supply stopcock.

Clean the filter and nozzle by washing in petrol or paraffin.

Make sure the filter medium is not damaged or defective.

Protect electrical gear from damp.

Warning

Never stand too near or put your face to the inspection or fire door, when the burner is about to start.

Never use a naked flame to ignite oil if the electrical ignition fails.

Always wait for about 10 minutes for the unburnt gases to disperse before restarting the oil burner if it has failed to ignite previously.

Installed by:

.....

Tel:

