



## **Bentone B 11, B 20**

Reservdelar och tillbehör

Spare Parts and Accessories

Ersatzteile und Zubehör

Pièces détachées et accessoires



MADE IN SWEDEN

Gäller från:

Valid from:

Gültig ab:

Valide du:

Serie 2

1.	Brännarrör - Flame tube - Brennerrohr - Tube de brûleur.....	6
2.	Insats - Nozzle assembly - Düsenstock - Gicleur.....	8
3.	Anslutningsfläns - Fixing flange - Anschlussflansch - Bride de fixation.....	11
4.	Kåpa - Cover - Haube - Capot.....	12
5.	Motor - Motor - Motor - Moteur.....	13
6.	Pump - Pump - Pumpe - Pompe.....	14
7.	Eldningsautomat - Oil burner control - Feuerungsautomat - Coffret de securite.....	16
8.	Fläkthus - Fan housing - Brennergehäuse - Carter du rotor.....	19
9.	Luftreglering - Air regulation - Fufteinstellung - Reglage d'air.....	20
10.	Transformator - Transformer - Transformator - Transformateur.....	21
11.	Slang - Flexible pipe - Ölschlauch - Flexible.....	22
12.	Tillbehör - Accessories - Zubehör - Accessoires.....	23

# TYP 11

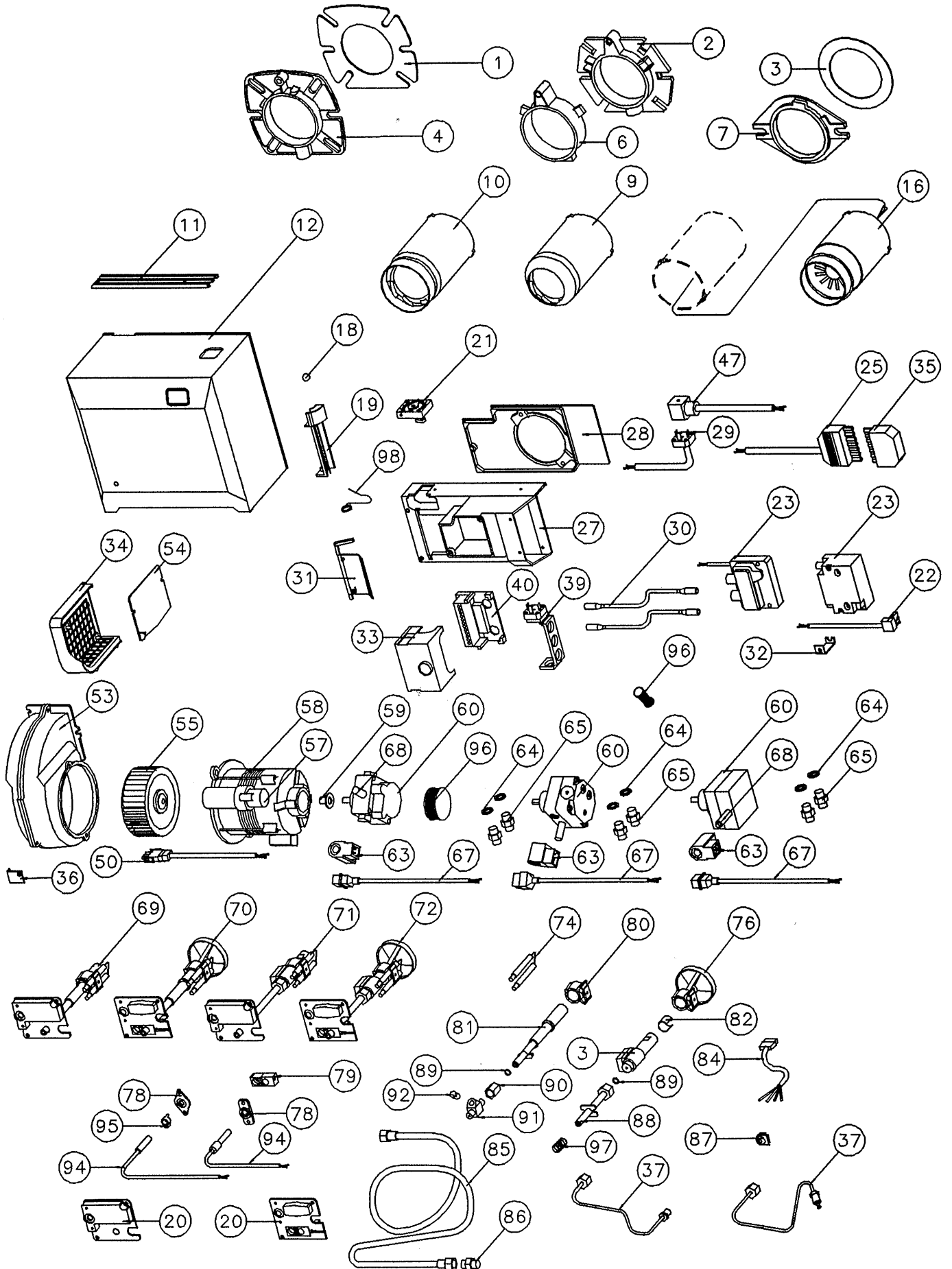

# TYP 20 serie 1

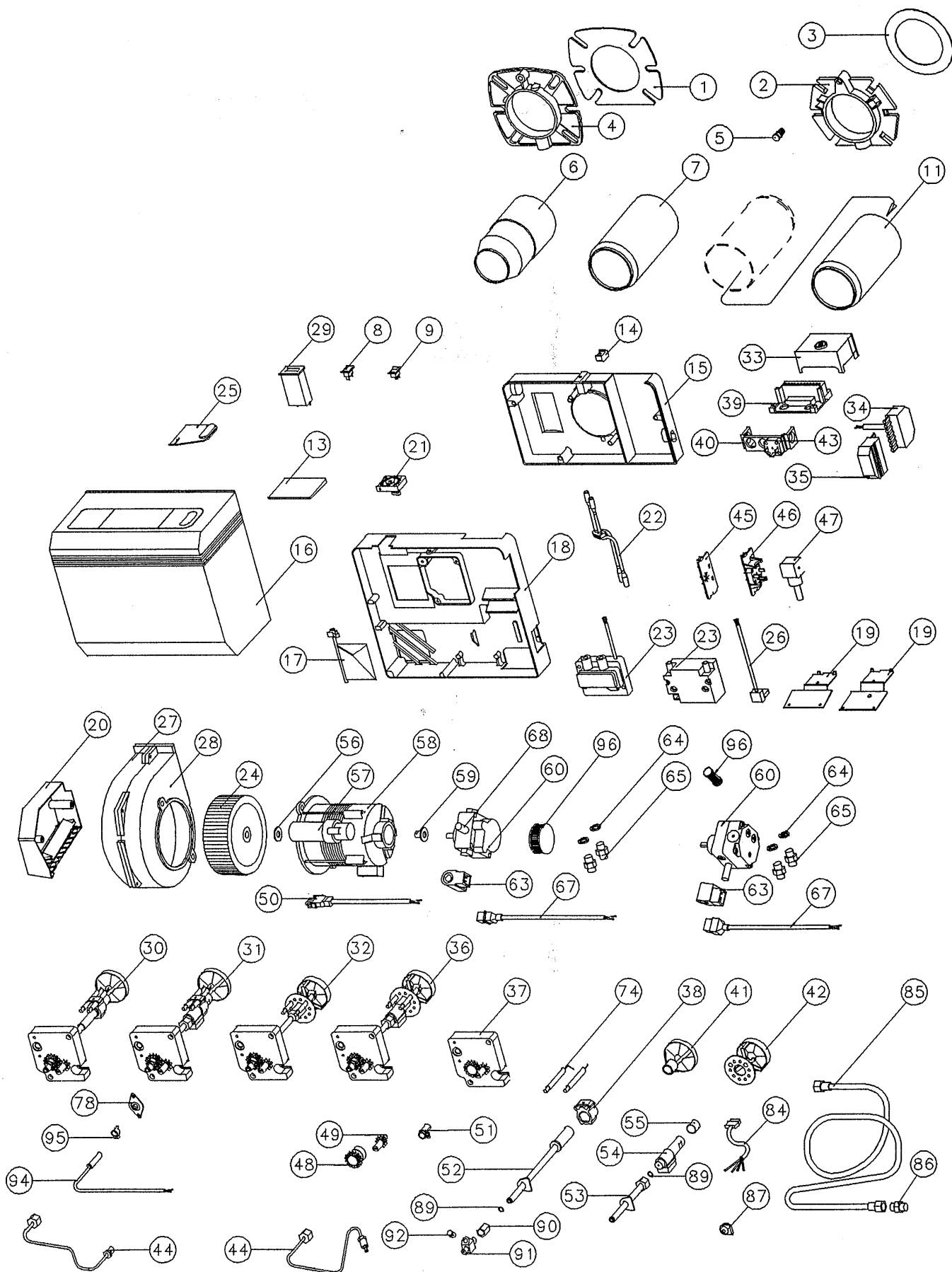

# TYP 20-2

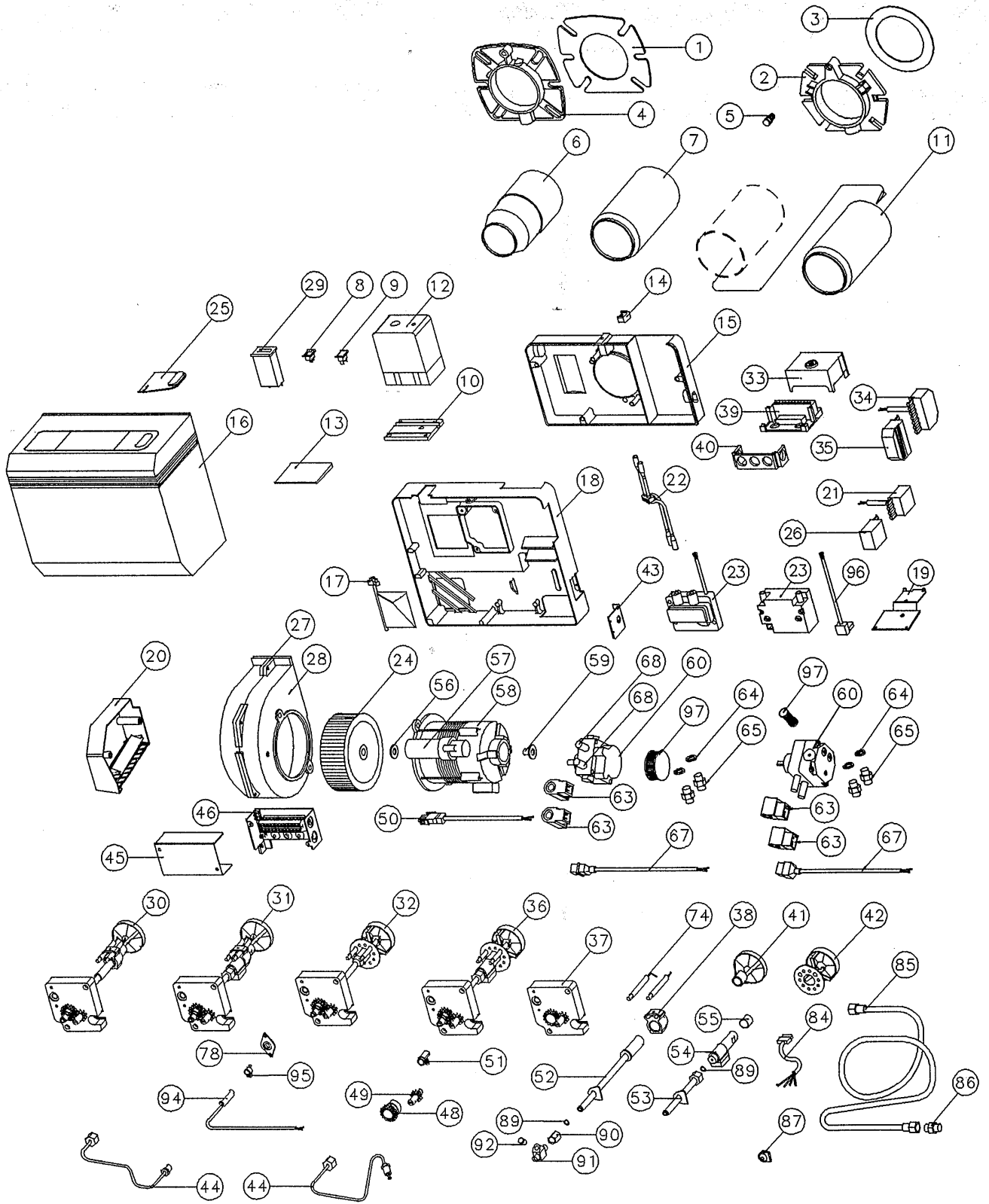

# 1. Brännarrör - Flame tube - Brennerrohr - Tube de brûleur

	Brännarrör FU, FUV	Flame tube	Brennerrohr	Tube de brûleur	
	B10				
	103 mm				11764301
	133 mm				11764304
	194 mm				11764303
	Brännarrör F, FV	Flame tube	Brennerrohr	Tube de brûleur	11591401
	B10 127 mm				
	Brännarrör L	Flame tube	Brennerrohr	Tube de brûleur	11702301
	B10 127 mm				
	10, 11				
	Brännarrör ZHV	Flame tube	Brennerrohr	Tube de brûleur	
	B10 129 mm				11752401
	B20 147 mm				11811101
	Brännarrör PL 10-7-10-4-21,5-10	Flame tube	Brennerrohr	Tube de brûleur	11782101
	B20 80 mm				
	Brännarrör PL 10-8-10-6-19-10	Flame tube	Brennerrohr	Tube de brûleur	
	B20 80 mm				11780401
	127 mm				11780402
	Brännarrör C	Flame tube	Brennerrohr	Tube de brûleur	11738502
	B20 147 mm				
	Brännarrör K, KV, KA, KAV	Flame tube	Brennerrohr	Tube de brûleur	
	B20 94 mm				11728401
	115 mm				17428410
	147 mm				11728402
	174 mm				11728408
	224 mm				11728403
	Brännarrör PL 6-7-19-10	Flame tube	Brennerrohr	Tube de brûleur	11780105
	B20 80 mm				

# Brännarrör - Flame tube - Brennerrohr - Tube de brûleur



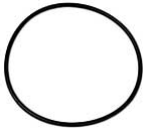

BENTONE

---

	Brännarrör, rostfritt K,KV, KA,KAV  B20 147 mm	Flame tube, Stainless	Brennerrohr, Edelstahl	Tube de brûleur, Inoxydable	11728409
	O-ring, Nitril 84,5 x 3  B10, B20	O-ring, Nitrile	O-Ring, Nitril	Joint torique, Nitrile	11316835

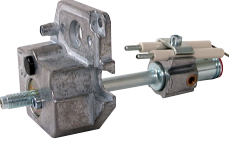
---

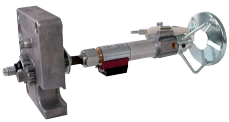
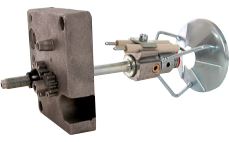
## 2. Insats - Nozzle assembly - Düsenstock - Gicleur

	Insats för brännarrör KAV 115 mm	Nozzle assembly for flame tube	Düsenstock für Brennerrohr	Ligne porte-gicleur pour tube de brûleur	11895803
	B10 Serie 2				
	Insats för brännarrör B10 Serie 2 L 80/ E 77 mm	Nozzle assembly for flame tube	Düsenstock für Brennerrohr	Ligne porte-gicleur pour tube de brûleur	11798701
	L 127/ E 124 mm				11798702
	E 154 mm				11798703
	E 215 mm				11798704
	Insats för brännarrör B10 Serie 2 FU 55/ F 80 mm	Nozzle assembly for flame tube	Düsenstock für Brennerrohr	Ligne porte-gicleur pour tube de brûleur	11798602
	FU 103/ F 127 mm				11798601
	FU 133/ F 157 mm				11798604
	FU 194/ F 218 mm				11798603
	Insats för brännarrör B10 Serie 2 FUV 102/ FV 127 mm	Nozzle assembly for flame tube	Düsenstock für Brennerrohr	Ligne porte-gicleur pour tube de brûleur	11798401
	FUV 132/ 157 mm				11798404
	FUV 193/ 218 mm				11798403
	Insats för brännarrör B20 KAV 147 mm	Nozzle assembly for flame tube	Düsenstock für Brennerrohr	Ligne porte-gicleur pour tube de brûleur	11742503
	KAV 224 mm				11742504
	Insats för brännarrör B20 K 94 mm	Nozzle assembly for flame tube	Düsenstock für Brennerrohr	Ligne porte-gicleur pour tube de brûleur	11731801
	K 147 mm				11731802
	K 224 mm				11731803
	KA 94 mm				11731804
	KA 147 mm				11731805
	KA 224 mm				11731806
	Insats För brännarrör KA 147 mm	Nozzle assembly For flame tube	Düsenstock Für Brennerrohr	Ligne porte-gicleur pour tube de brûleur	11895801
	B10 Serie 2				









# Insats - Nozzle assembly - Düsenstock - Gicleur

BENTONE

	Oljerör för brännarrör	Nozzle pipe for flame tube	Düsenrohr für Brennerrohr	Canne porte-gicleur pour tube de brûleur	
	B10 Serie 2				
	56, 80 mm				11756902
	103 mm				11756901
	133, 157 mm				11756904
	194, 218 mm				11756903
	B20				
	94 mm				11731601
	147 mm				11731602
	224 mm				11731603
B10, B20 Serie 2					
174 mm				11731604	
	Oljerör, förvärmning för brännarrör	Nozzle for preheating for flame tube	Düsenrohr für Vorwärmung für Brennerrohr	Canne porte-gicleur pour réchauffage pour tube de brûleur	
	B10 Serie 2				
	103, 115, 127 mm				11742103
	133, 157 mm				11742106
	194, 218 mm				11742105
	B20				
	147 mm				11742101
	144 mm				11742108
	224 mm				11742102
		Bromsskiva kompl. F, FV, FU, FUV	Brake plate compl.	Stauscheibe kompl.	Disque accroche flamme
B10					
	Bromsskiva ZHV	Brake plate	Stauscheibe	Disque accroche flamme	11835501
	B10, B20				
	Bromsskiva K, KV	Brake plate	Stauscheibe	Disque accroche flamme	11731701
	B20				
	Bromsskiva KA, KAV	Brake plate	Stauscheibe	Disque accroche flamme	11885801
	B10, B20				

# Insats - Nozzle assembly - Düsenstock - Gicleur

BENTONE







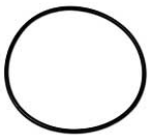

	Elektrodhållare kompl.	Electrode holder compl.	Elektrodenhalter kompl.	Porte-électrode compl.	11598401
	Tändelektrod	Ignition electrode	Zündelektrode	Electrode d'allumage	11593701
	Par	Pair of	Paar	1 paire	91593701
	Förvärmare FPHE5 30-110W 70°	Preheater	Vorwärmer	Réchauffeur	12086705
	Förvärmare FPHE10 30-190W 70°	Preheater	Vorwärmer	Réchauffeur	12086707
	B20 ZHV				
	Kabel, förvärmare 320 mm	Cable, preheater	Kabel, Vorwärmer	Cable, réchauffeur	11477706
	Kabel, förvärmare med clips	Cable, preheater with clips	Kabel, Vorwärmer mit Klammern	Cable, réchauffeur avec crampons	11477712
	B10 Serie 2				
	Lock, insats  B20	Cover, nozzle assembly	Deckel, Düsenstock	Couvercle, Ligne porte-gicleur	11766201
	O-ring FPM75  4.48 x 1.78 mm	O-ring	O-Ring	Joint torique	11316802
	Distansring F, FV, FU, FUV  B10	Spacer ring	Abstandsring	Bague d'écartement	11593601
	Kabelgenomföring	Cable inlet	Kabeldurchführung	Douille de passage de câble	11589801
	Distansrör C KV, KAV  B20	Spacing tube	Abstandsrohr	Tube d'écartment	11741601
					11741602

### 3. Anslutningsfläns - Fixing flange - Anschlussflansch - Bride de fixation

BENTONE

	Munstycksnyckel	Nozzle key	Düsenschlüssel	Clé de gicleur	11024201
	Anslutningsfläns	Fixing flange	Anschlussflansch	Bride de fixation	0439030834
	Anslutningsfläns	Fixing flange	Anschlussflansch	Bride de fixation	11811601
	Anslutningsfläns B10, B20	Fixing flange	Anschlussflansch	Bride de fixation	11811602
	Packning	Gasket	Dichtung	Joint	11819101
	Packning	Gasket	Dichtung	Joint	11132202
	Packning	Gasket	Dichtung	Joint	0439012027
	Mellandel	Spacing piece	Zwischenteil	Pièce intermédiaire, bride	
	B20				11712102
	B10 Serie 2				11851501
	Skruv,	Screw,	Schraube,	Vis,	11412162
	upphängning för mellandel	suspension for spacing piece	Aufhängung für Zwischenteil	suspension pour pièce intermédiaire	11412163
	B10 Serie 2				

## 4. Kåpa - Cover - Haube - Capot









	O-ring B10 Serie 2 B20 Serie 2	O-ring	O-Ring	Joint torique	11316835
	Axel, fläns	Axle, flange	Achse, Flansch	Arbre, de bride	11735201
	Förlängd	Lengthened	Verlängert	Allongé	11735204
	B20				
	Kåpa	Cover	Haube	Capot	
	Blå	Blue	Blau	Bleu	11788307
	Grå	Grey	Grau	Gris	11788323
	B10 Serie 2 B20 Serie 2				
	Fäste	Holder	Halter	Support	
	B10 Serie 2 B20 Serie 2				11789701 11789702
	Skruv	Screw	Schraube	Vis	11790001
	B10 Serie 2 B20 Serie 2				
	Täckbricka	Cover plate	Abdeckscheibe	Plaque de recouvrement	11789211
	B10 Serie 2 B20 Serie 2				
	Täckbricka	Cover plate	Abdeckscheibe	Plaque de recouvrement	11789202
	B10 Serie 2 B20 Serie 2				
	Täckbricka	Cover plate	Abdeckscheibe	Plaque de recouvrement	11789204
	B10 Serie 2 B20 Serie 2				
	Täckbricka	Cover plate	Abdeckscheibe	Plaque de recouvrement	11789205
	B10 Serie 2 B20 Serie 2				

## 5. Motor - Motor - Motor - Moteur

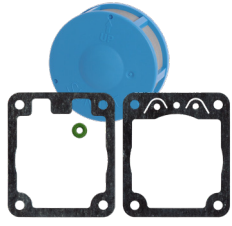
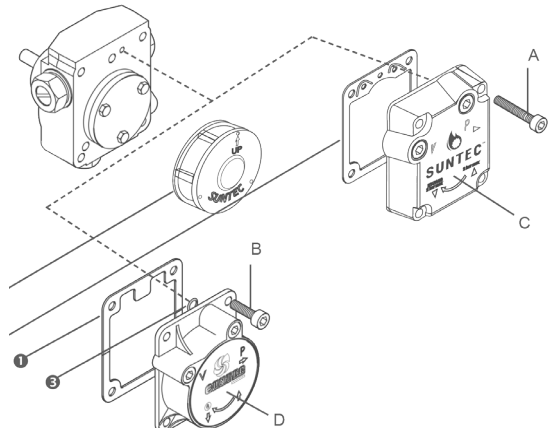
	Motor Hanning, 90W, 4µF B11, B20	Motor	Motor	Moteur	12090101
	med kabel och koppling	with cable and coupling	mit Kabel und Kupplung	avec câble et accouplement	92090101
	Motor Simel, 90W, 6.3µF B11, B20	Motor	Motor	Moteur	12128501
	med kabel och koppling	with cable and coupling	mit Kabel und Kupplung	avec câble et accouplement	92128501
	Motor, 1-fas, 125W 230V, 50/60Hz B20-2	Motor, 1-phase	Motor, 1-phasig	Moteur, monophasé	12091801
	med kabel och koppling	with cable and coupling	mit Kabel und Kupplung	avec câble et accouplement	92091801
	Kondensator för motor B11, B20	Capacitor for motor	Kondensator für motor	Condensateur pour moteur	
	4 µF FHP, AEG, Hanning				12093001
	6.3 µF Simel				12093701
	Fläkthjul B11	Fan wheel	Gebläserad	Rotor	11592701
	B20				11727601
	Koppling, FHP, AEG, Hanning B11, B20	Coupling	Kupplung	Accouplement	12059301
	Koppling, Simel, svart B11, B20	Coupling, Simel, Black	Kupplung, Simel, Schwarz	Accouplement, Simel, Le noir	11756802
	Koppling B20-2	Coupling	Kupplung	Accouplement	11756802
	Kondensator med hylsa	Capacitor with sleeve	Kondensator mit Hülse	Condensateur avec douille	
	5µF B20-2				91775102
	4µF B10, B20				11775101
	Kabel Hanning, Simel, FHP, AEG B11, B20	Cable	Kabel	Câble	12086601

## 6. Pump - Pump - Pumpe - Pompe

	Pump BFP41L3 B10, B20 Styckförpackning Med kabel	Pump Single-piece package With cable	Pumpe Stückverpackung Mit Kabel	Pompe Emballage par pièces Avec câble	92074001
	Pump BFP21L3LE B10 Serie 2 B20 Serie 2 Styckförpackning med kabel	Pump Single-piece package with cable	Pumpe Stückverpackung mit Kabel	Pompe Emballage par pièces avec câble	92074022
	Pump BFP11L3 B20 Styckförpackning med kabel	Pump Single-piece package with cable	Pumpe Stückverpackung mit Kabel	Pompe Emballage par pièces avec câble	12074002 92074006
	Pump BFP52E B20 Styckförpackning med kablar	Pump Single-piece package with cables	Pumpe Stückverpackung mit Kabeln	Pompe Emballage par pièces avec câbles	92074009
	Magnetventil BFP41L3 Innerdel	Solenoid valve Inner part	Magnetventil Einsatz	Electrovanne Partie interieure	11597303 11774201
	Magnetventil BFP52 B20 Steg 1 Steg 2 NO	Solenoid valve Stage 1 Stage 2 NO	Magnetventil Stufe 1 Stufe 2 NO	Electrovanne 1ère allure 2ème allure NO	11597303 11597304
	Spole MS11 BFP BFP Steg2 NO	Coil Coil Coil Stage 2 NO	Spule Spule Spule Stufe 2 NO	Bobine Bobine Bobine 2ème allure NO	91597401 11597404 11597405
	Filter BFP41L3	Filter	Filter	Filtre	11774901
	Packing, lock BFP B10, B20	Gasket, cover	Dichtung, Deckel	Joint, couvercle	11981001
	Pump AS47C-6P 2-rörs Styckförpackning med kabel	Pump 2-pipe Single-piece package with cable	Pumpe 2-Rohr Stückverpackung mit Kabel	Pompe 2 tuyaux Emballage par pièces avec câble	12026432 82026432 92026432
	Pump AS47C-6M 1-rörs Styckförpackning med kabel	Pump 1-pipe Single-piece package with cable	Pumpe 1-Rohr Stückverpackung mit Kabel	Pompe 1 tuyau Emballage par pièces avec câble	12026431 82026431 92026431
	Pump AT245C-4P B20 Styckförpackning med kablar	Pump Single-piece package with cables	Pumpe Stückverpackung mit Kabeln	Pompe Emballage par pièces avec câbles	12026421 82026421 92026421

	Magnetventil AS47C	Solenoid valve	Magnetventil	Electrovanne	
	AT steg 1	AT stage 1	AT stufe 1	AT 1ère allure	91597201
	AT steg 2	AT stage 2	AT stufe 2	AT 2ème allure	11597204
	Spole	Coil	Spule	Bobine	91597101
	AS/AP/AT/AL				
	Filtersats, filter, packningar, o-ring	Filter kit, filter, gaskets, o-ring	Filter Kit, Filter, Dichtungs, O-Ring	Kit de filtre, filtre, joint, joint torique	11457002
	Suntec, AN,AS,AP,AT,AL-67				
					
	Magnetventilkabel	Cable, solenoid valve	Kabel, Magnetventil	Câble, électrovanne	
	630 mm AS47C				11597507
	400 mm MS11L3				11597505
	Förbindelserör	Connecting pipe	Öldruckrohr	Trompette	11732701
	AS47C				
	B20				
	Förbindelserör	Connecting pipe	Öldruckrohr	Trompette	11783602
	BFP				
	B20				
	Nippel, rak	Nipple, straight	Gerader Nippel	Raccord, droit	11757401
	1/4"-1/4"				
	B9 - B20				
	Vinkelnippel	Nipple, elbow	Ellbogen	Raccord, coudé	0439085229
	B10, B11				
	Kopparpackning	Copper gasket	Kupferdichtung	Joint en cuivre	11021210

## 7. Eldningsautomat - Oil burner control - Feuerungsautomat - Coffret de securite

BENTONE

	Reläbox LOA 24	Control box	Steuergerät	Boite de contrôle	11559504
	Styckförpackning	Single-piece package	Stückverpackung	Emballage par pièces	91559504
	Reläbox	Control box	Steuergerät	Boîte de relais	
	TF 834E.3				11702704
	Styckförpackning	Single-piece package	Stückverpackung	Emballage par pièces	91702704
	TF 832.3				11781007
	Ersättning för BHO12	Replacement for BHO12	Ersatz für BHO12	Remplacement de BHO12	11799902
	Reläsockel kompl.	Relay base compl.	Steuergerät Unterteil kompl.	Socle de raccordement compl.	91991001
	Reläsockel	Relay base	Steuergerät Unterteil	Socle de raccordement	11559600
	Gavel Kompl.	Front plate Compl.	Frontplatte Kompl.	Plaque frontale Compl.	11559690 91559600
	Reläsockel	Relay base	Steuergeräatunterteil	Socle de raccordement	
	10 Serie 2				
	med kablar för kallstart	with cables for cold start	mit Kabeln für Kaltstart	avec Câbles pour démarrage à froid	11801202
	med kontaktdon 7-pol	with plug-in contact 7-pole	mit Buchsenteil 7-polig	avec prise "européenne" 7-polaire	
	för förvärmning	for preheating	für Vorwärmung	pour réchauffage	11801209
för kallstart	for cold start	für Kaltstart	pour démarrage à froid	11801210	
	Fläns, fotomotstånd	Flange, photoresistor	Flansch, Fotowiderstand	Bride, cellule photorésistante	
	B10				0039011303
	B10 Serie 2, B20				0039011302
	Fotomotstånd kort utförande QRB1-B, L=350 mm B10, B20	Photoresistor short design	Fotowiderstand kurze Ausführung	Cellule photorésistante version courte	91240905
	Fotomotstånd långt utförande QRB1-A, L=360 mm B10	Photoresistor long design	Fotowiderstand lange Ausführung	Cellule photorésistante version longue	91240907



	Fotomotstånd MZ 770 S	Photoresistor	Fotowiderstand	Cellule Photorésistante	11800301
	B10, B20				
	Fotomotstånd 057H20.2 480 mm	Photoresistor	Fotowiderstand	Cellule Photorésistante	91240900
	B20				
	Fotomotstånd MZ 770	Photoresistor	Fotowiderstand	Cellule Photorésistante	0439029567
	B10				
	Flimmerdetektor B10 Serie 2	Flicker detector	Flackerdetektor	Détecteur de vasillation	11865202
	Flimmerdetektor med clips	Flicker detector with clips	Flackerdetektor mit Klammern	Détecteur de vasillation avec crampons	11865201
	B10 Serie 2, B20				
	Kontaktдон, hondel 3-pol 1750 mm	Plug-in contact, female 3-pole	Buchsenteil 3-polig	Fiche de Prise de courant femelle 3-polaire	11704601
	Kontaktдон	Plug-in contact	Stecker und Buchsenteil	Fiche de Prise de	
	7-pol hane	7-pole male	7-polig Steckerteil	7-polaire mâle	11558500
	7-pol hona	7-pole female	7-polig Buchsenteil	7-polaire femelle	91558501
	Fläns, fotomotstånd	Flange, photoresistor	Flansch, Fotowiderstand	Bride, cellule photorésistante	11240501
	B10, B20				
	Kontaktдон	Plug-in contact	Stecker und Buchsenteil	Fiche de Prise de	
	4-pol hane	4-pole male	4-polig Steckerteil	4-polaire mâle	11919701
	4-pol hona	4-pole female	4-polig Buchsenteil	4-polaire femelle	11919801
	Indikeringslampa, grön B10 Serie 2, B20	Indicating lamp, green	Anzeigelampe, grün	Lampe témoin, vert	11721103

	Timmätare B10, B20	Time meter	Betriebsstundenzähler	Compteur horaire	11767801
	Kabelgenomföring	Cable inlet	Kabeldurchführung	Douille de passage câble	11810001
	Tidräknare kompl. 1000	Time meter compl.	Betriebsstundenzähler kompl.	Compteur horaire compl.	11847201
	Konsol kompl. med indikeringslampa och reläfäste	Fixing plate compl. with indicating lamp and relay base	Konsole kompl. mit Anzeigelampe und Relaishalter	Platine de raccordement, lampe témoin et plaque de fixation	11860301
	B10 Serie 2 med tidräknare 1000	with time meter 1000	mit Betriebs- stundenzähler 1000	avec compteur horaire 1000	11860302
	Stömbrytare	Switch	Schalter	Interrupteur	
	0-I				12132201
	I-II				12132202
B20					
	Kåpa koppl. dosa	Cover, terminal board	Haube, Klemmbrett	Capot bornier	11047201
B20					
	Tidräknare kompl.	Time meter compl	Betriebsstundenzähler kompl.	Compteur horaire compl.	11847202
B10 Serie 2					
	Panel	Electric panel	Deckel für Schaltbrett	Panneau	11753902
	B20				
	Panel	Electric panel	Deckel für Schaltbrett	Panneau	11732201
	B20				
	Kabel MZ770	Cable	Kabel	Câble	11856101

## 8. Fläkthus - Fan housing - Brennergehäuse - Carter du rotor

BENTONE

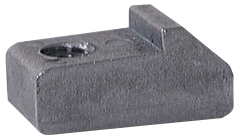

Låsstycke

B20

Locking piece,  
flange









Verriegelungs-  
stück, Flansch

Pièce de blocage  
de bride

11735301





## 9. Luftreglering - Air regulation - Fufteinstellung - Reglage d'air

BENTONE





	Självstängande luftspjäll	Automatic air damper	Luftansaug- vorrichtung	Clapet d'air automatique	11594701
	B10, B20				
	Fjäder	Spring	Feder	Ressort	11815601
	B20 Serie 2				
	Ställklack	Locating block	Regulierstück	Dispositif de réglage de l'air	11728001
	B11				
	Ljuddämpare	Silencer	Schalldämpfer	Silencieux	117 113 01
	B11				
	Ställskruv	Set screw	Stellschraube	La vis de réglage	11749401
	B10 Serie 2 B20 Serie 2				
	Skala	Scale	Skala	Echelle	
	B10 Serie 2				11788001
	B20 Serie 2				11788002
	Luftintag	Air intake	Luftansauggehäuse	Caisson d'admission d'air	11813801
	Spjällmotor LKS120-05	Damper motor	Stellmotor	Servo moteur	11745701
	B20-2				

# 10. Transformator - Transformer - Transformator - Transformateur

BENTONE

	Transformator EBI	Transformer	Transformator	Transformateur	12064301
	Med kabel	With cable	Mit Kabel	Avec Câble	92064301
	Kabel, transformator	Cable, transformer	Kabel, Transformator	Câble, transformateur	12062002
	400 mm				
	Kabel, transformator med clips Danfoss EBI	Cable, transformer with clips	Kabel, Transformator mit Klammern	Câble, transformateur avec crampons	11757012
	B10 Serie 2 B20 Serie 2				
	Tändkabelpar	Set of ignition cables	Zündkabelpaar	Câble H.T. 1 paire	
	B10, B20				
	300 mm				12067830
	350 mm				12067835
250 mm					12067825

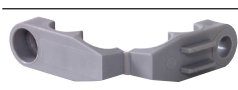
# 11. Slang - Flexible pipe - Ölschlauch - Flexible

	<p>Oljeslang med rak nippel B10, B20</p>	<p>Flexible pipe with straight nipple</p>	<p>Ölschlauch mit geradem Nippel</p>	<p>Flexible avec raccord droit</p>	
	<p>L=900</p>				<p>121100015</p>
	<p>L=700</p>				<p>11554507</p>
	<p>Oljeslang, vinkel B10, B20</p>	<p>Flexible pipe with angle nipple</p>	<p>Ölschlauch mit Winkelnippel</p>	<p>Flexible avec raccord coudé</p>	
	<p>L=900</p>				<p>12110014</p>
	<p>L=1500</p>				<p>12110016</p>
	<p>Slangnippel B10, B20 1/4"-14" 3/8"-1/4" 1/2"-1/4"</p>	<p>Nipple, flexible pipe</p>	<p>Nippel, Ölschlauch</p>	<p>Raccord pour flexible</p>	
					<p>11757401</p>
					<p>11246002</p>
					<p>11246003</p>
	<p>Klammer B10, B20</p>	<p>Bracket</p>	<p>Klammer</p>	<p>Crampon</p>	<p>11751101</p>
	<p>Vinkelnippel 1/4"x1/4"</p>	<p>Nipple, elbow</p>	<p>Nippel, winkelförmig</p>	<p>Raccord, coudé</p>	<p>0439085229</p>

## 12. Tillbehör - Accessories - Zubehör - Accessoires

	Oljefilter, Plast 1/4RP 15µM 70313P	Oil filter, Plastic	Ölfiter, Kunststoff	Filtre à fioul, Plastique	11429311 11932301
	För Eo 1 och HVO/XTL	For Fuel oil and HVO/XTL	Für Heizöl und HVO/XTL	Pour l'huile de chauffage et HVO/XTL	
	Filtersats 60200/00015P	Filter set	Filtersatz	Jeu de filtre	12128901
	För filter 11429311	For Filter 11429311	Für Filter 11429311	Pour filtre 11429311	
	Oljefilter ALU 3/8RP 100µM 70311AE, Viton	Oil filter ALU	Ölfiter ALU	Filtre à fioul ALU	11429313 11429303
	För Eo 1, HVO/XTL och FAME/RME	For Fuel oil, HVO/XTL and FAME/RME	Für Heizöl, HVO/XTL und FAME/RME	Pour l'huile de chauffage, HVO/XTL et FAME/RME	
	Packningssats 3203V, Viton	Gasket set	Dichtungssatz	Kit d'emballage	11885314 11885304
	För filter 11429303, 11429311 och 11429313	For Filter 11429303, 11429311 and 11429313	Für Filter 11429303, 11429311 und 11429313	Pour filtre 11429303, 11429311 et 11429313	
	Oljefilter, Plast 1/4RP 100M 70452P	Oil filter, Plastic	Ölfiter, Kunststoff	Filtre à fioul, Plastique	11429305 11429306
	För Eo 1 och HVO/XTL	For Fuel oil and HVO/XTL	Für Heizöl und HVO/XTL	Pour l'huile de chauffage et HVO/XTL	
	Packningssats	Gasket set	Dichtungssatz	Kit d'emballage	11885301
	För filter 11429305 och 11429306	For Filter 11429305 and 11429306	Für Filter 11429305 und 11429306	Pour filtre 11429305 et 11429306	



CTC AB Box 309 SE-341 26 Ljungby

[info@bentone.se](mailto:info@bentone.se) +46 372 88 000

[www.bentone.se](http://www.bentone.se)