



Bentone B 50, B60

Reservdelar och tillbehör

Spare Parts and Accessories

Ersatzteile und Zubehör

Pièces détachées et accessoires



MADE IN SWEDEN



B50, B60

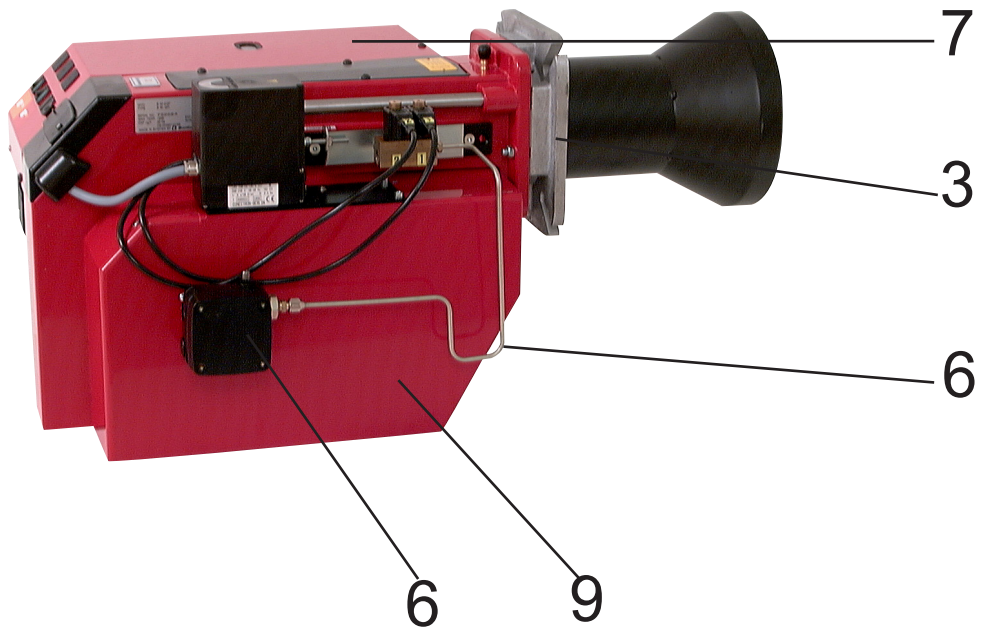
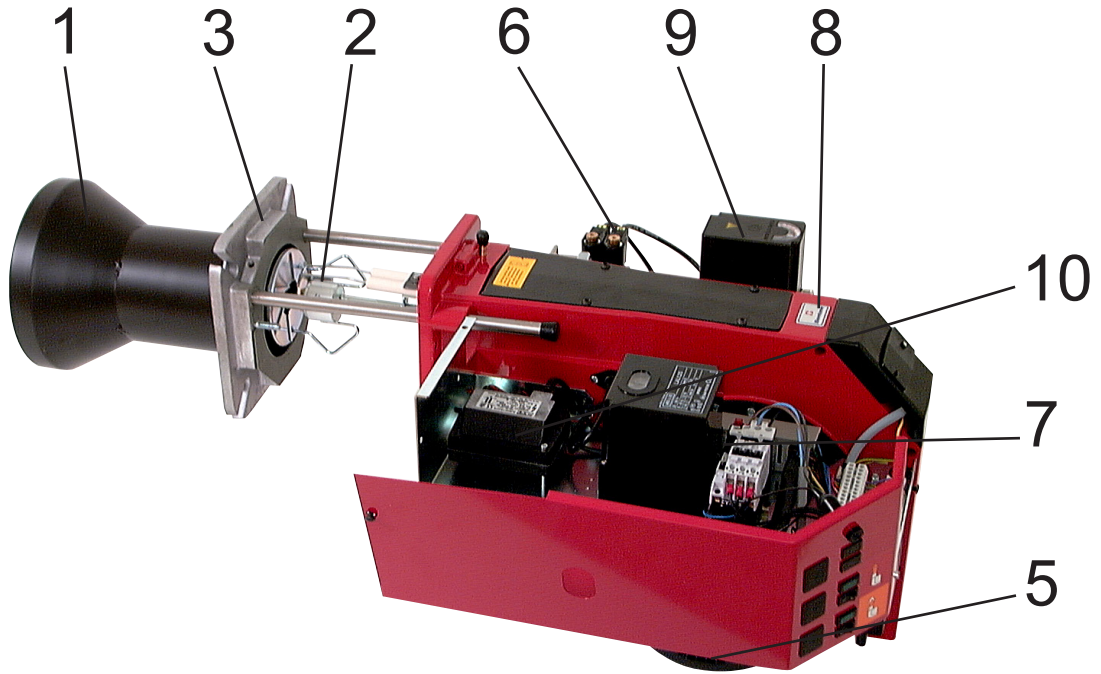

INNEHÅLLSFÖRTECKNING INHALTSVERZEICHNIS

TABLE OF CONTENTS TABLE DES MATIERES

1. BRÄNNARRÖR	BRENNERROHR
BLAST TUBE	TUBE DIFFUSEUR
2. INSATS	DÜSENSTOCK
NOZZLE ASSEMBLY	LIGNE PORTE-GICLEUR
3. ANSLUTNINGSFLÄNS	ANSCHLUSSFLANSCH
FIXING FLANGE	BRIDE DE FIXATION
4. KÅPA	HAUBE
COVER	CAPOT
5. MOTOR	MOTOR
MOTOR	MOTEUR
6. PUMP	PUMPE
PUMP	POMPE
7. ELDNINGSAUTOMAT	FEURUNGSAUTOMAT
OIL BURNER CONTROL	COFFRET DE SECURITE
8. TRANSFORMATOR	TRANSFORMATOR
TRANSFORMER	TRANSFORMATEUR
9. LUFTREGLERING	LUFTEINSTELLUNG
AIR REGULATION	REGLAGE D'AIR
10. FLÄKTHUS	BRÄNNERGEHÄUSE
FAN HOUSING	CARTER DU ROTOR
11. ÖVRIGT	VERSCHIEDENES
SUNDRIES	SUNDRIES
12. TILLBEHÖR	ZUBEHÖR
ACCESSORIES	ACCESSOIRES

B50, B60

BRÄNNARRÖR BLAST TUBE

BRENNERROHR TUBE DIFFUSEUR

1



Flambägare
Brännarhuvud 1

Flame cone
Burner head 1

Flammentrichter
Brennerkopf 1

Cône de flamme
Tête de combustion 1

361 mm
50

365 mm
50

365 mm
50

365 mm
50

115 385 0205



Flambägare
Brännarhuvud 2

Flame cone
Burner head 2

Flammentrichter
Brennerkopf 2

Cône de flamme
Tête de combustion 2

280 mm
380 mm
50

280 mm
380 mm
50

280 mm
380 mm
50

280 mm
380 mm
50

114 452 01

114 452 0205



Brännarrör

Burner tube

Brennerrohr

Tube diffuseur

365 mm
50

365 mm
50

365 mm
50

365 mm
50

113 152 02



Flambägare

Flame cone

Flammentrichter

Cône de flamme

343 mm
443 mm
60

343 mm
443 mm
60

343 mm
443 mm
60

343 mm
443 mm
60









113 762 0305

113 762 0405

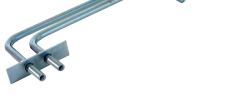
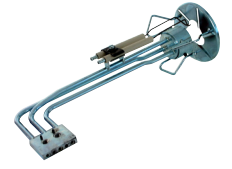
B50, B60

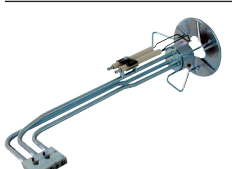
INSATS NOZZLE ASSEMBLY





DÜSENSTOCK LIGNE PORTE-GICLEUR 2

	Insats 50-1	Nozzle assembly 50-1	Düsenstock 50-1	Ligne porte-gicleur 50-1	118 452 01
	Insats Standard Långt utförande före 1996 50-2H före 9432 50-2	Nozzle assembly Standard Long design before 1996 50-2H before 9432 50-2	Düsenstock Standard Längere Ausführung vor 1996 50-2H vor 9432 50-2	Ligne porte-gicleur Standard Modèle long avant 1996 50-2H avant 9432 50-2	118 410 01 118 410 02
	Insats Brännarhuvud 2 långt utf.	Nozzle assembly Burner head 2 Long design	Düsenstock Brennerkopf 2 Längere Ausführung	Ligne porte-gicleur Tête de combustion 2 Modèle long	118 508 01 118 508 03
	Brännarhuvud 1 långt utf. 50-2	Burner head 1 Long design 50-2	Brennerkopf 1 Längere Ausführung 50-2	Tête de combustion 1 Modèle long 50-2	118 508 02 118 508 04
	Insats 50-3	Nozzle assembly 50-3	Düsenstock 50-3	Ligne porte-gicleur 50-3	118 526 01
	Insats 60-2	Nozzle assembly 60-2	Düsenstock 60-2	Ligne porte-gicleur 60-2	118 547 01
	Insats 60-3	Nozzle assembly 60-3	Düsenstock 60-3	Ligne porte-gicleur 60-3	118 548 01
	Oljerör 50-3 60-3	Nozzle line 50-3 60-3	Düsenrohr 50-3 60-3	Canne porte-gicleur 50-3 60-3	118 476 01 118 414 01
	Oljerör Standard Långt utförande 50-2 Standard Långt utförande 60-2	Nozzle line Standard Long design 50-2 Standard Long design 60-2	Düsenrohr Standard Längere Ausführung 50-2 Standard Längere Ausführung 60-2	Canne porte-gicleur Standard Modèle long 50-2 Standard Modèle long 60-2	118 478 01 118 478 02 118 104 01 118 104 02
	Oljerör Standard Långt utförande före 1996 50-2H före 9432 50-2	Nozzle line Standard Long design before 1996 50-2H before 9432 50-2	Düsenrohr Standard Längere Ausführung vor 1996 50-2H vor 9432 50-2	Canne porte-gicleur Standard Modèle long avant 1996 50-2H avant 9432 50-2	118 006 01 118 006 02

B50, B60

INSATS NOZZLE ASSEMBLY

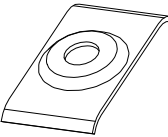
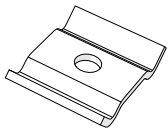
DÜSENSTOCK LIGNE PORTE-GICLEUR 2

	Oljerör 50-1	Nozzle line 50-1	Düsenrohr 50-1	Canne porte-gicleur 50-1	118 019 01
	Bromsskiva Ø 100mm 50-2/1F	Brake plate Ø 100 mm 50-2/1F	Stauscheibe Ø 100 mm 50-2/1F	Disque accroche- flamme Ø 100 mm 50-2/1F	112 841 44
	Ø 100mm 50-2	Ø 100 mm 50-2	Ø 100 mm 50-2	Ø 100 mm 50-2	112 841 07
	Ø 110mm 60-2	Ø 110 mm 60-2	Ø 110 mm 60-2	Ø 110 mm 60-2	112 841 45
	Ø 120mm 60-2F	Ø 120 mm 60-2F	Ø 120 mm 60-2F	Ø 120 mm 60-2F	112 841 15
	Bromsskiva 60-3 Ø 120mm	Brake plate 60-3 Ø 120mm	Stauscheibe 60-3 Ø 120mm	Disque accroche- flamme 60-3 Ø 120mm	112 841 19
	Klammer	Bracket	Klammer	Support	112 738 01
	Klammer	Bracket	Klammer	Support	111 552 01
	Tändelektrod Par 50-3, 60-3	Ignition electrode Pair 50-3, 60-3	Zündelektrode Paar 50-3, 60-3	Électrode d'allumage à paire 50-3, 60-3	119 247 01 919 247 01
	Tändelektrod Par 50-2, 60-2	Ignition electrode Pair 50-2, 60-2	Zündelektrode Paar 50-2, 60-2	Électrode d'allumage à paire 50-2, 60-2	119 246 01 919 246 01

B50, B60

INSATS NOZZLE ASSEMBLY

DÜSENSTOCK LIGNE PORTE-GICLEUR 2

	Distanshylsa 50-2, 60-2	Distance sleeve 50-2, 60-2	Abstandshülse 50-2, 60-2	Douille d'écartement 50-2, 60-2	118 292 01
	Axel 50-3 50-2 60-3 60-2	Axle 50-3 50-2 60-3 60-2	Welle 50-3 50-2 60-3 60-2	Arbre 50-3 50-2 60-3 60-2	918 298 01 918 298 02 918 298 03 918 298 04
	Ställplatta 50-2, 60-2	Adjustment plate 50-2, 60-2	Stellplatte 50-2, 60-2	Platine de réglage 50-2, 60-2	118 229 01
	Ställplatta 50-1	Adjustment plate 50-1	Stellplatte 50-1	Platine de réglage 50-1	118 025 01
	Ställskena 50-3, 60-3	Adjustment bar 50-3, 60-3	Regulierstab 50-3, 60-3	Barre de réglage 50-3, 60-3	118 450 01
	Reglerdon RSA 50-R, 60-R AT3-65C	Adjustment device RSA 50-R, 60-R AT3-65C	Regelgerät RSA 50-R, 60-R AT3-65C	Dispositif de réglage RSA 50-R, 60-R AT3-65C	918 299 04 918 299 01
	Packningssats, reglerdon	Gasket set, adjustment device	Dichtungssatz, Regelgerät	Jeu de joint, dispositif de réglage	118 322 02
	Munstycksnyckel	Nozzle key	Düsen Schlüssel	Clé de gicleur	113 461 01
	O-ring, insats- magnetventilblock 50-3, 60-3	O-ring, nozzle assembly- solenoid valve bloc 50-3, 60-3	O-Ring, Düsenstock- Magnetventilblock 50-3, 60-3	Joint torique, ligne porte-gicleur- jeu d'électrovanne 50-3, 60-3	113 168 02
	Ställplatta 50-R, 60-R	Adjustment plate 50-R, 60-R	Stellplatte 50-R, 60-R	Platine de réglage 50-R, 60-R	918 288 01

B50, B60

ANSLUTNINGSFLÄNS FIXING FLANGE

ANSCHLUSSFLANSCH BRIDE DE FIXATION

3

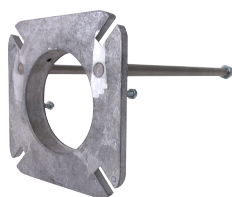

Anslutningsfläns komplett	Fixing flange complete	Anschlussflansch komplett	Bride de fixation complet	
50	50	50	50	118 230 01
60	60	60	60	118 490 01
Anslutningsfläns	Fixing flange	Anschlussflansch	Bride de fixation	
50	50	50	50	117 975 01
60	60	60	60	118 235 01
Gejder	Guide bar	Führungsschiene	Barre de guidage	118 093 01



Packning fläkthus- fläns	Gasket fan housing- flange	Dichtung Brennergehäuse- Flansch	Joint, carter du rotor- bride	118 397 01
50	50	50	50	



Packning	Gasket	Dichtung	Joint	
50	50	50	50	112 788 02
60	60	60	60	112 788 03



Packning, fläkthus- fläns	Gasket, fan housing- flange	Dichtung, Brennergehäuse- Flansch	Joint, carter du rotor- bride	118 398 01
60	60	60	60	

B50, B60

MOTOR MOTOR

MOTOR MOTEUR

5



Motor
0,75 kW 1-fas
0,75 kW 3-fas
50

1,1 kW 1-fas
1,1 kW 3-fas
60

Motor
0,75 kW 1-phase
0,75 kW 3- phase
50

1,1 kW 1- phase
1,1 kW 3- phase
60

Motor
0,75 kW 1-phasig
0,75 kW 3- phasig
50

1,1 kW 1-phasig
1,1 kW 3-phasig
60

Moteur
0,75 kW monophasé
0,75 kW triphasé
50

1,1 kW monophasé
1,1 kW triphasé
60

117 911 08
117 911 06

117 911 09
117 911 02



Fläkthjul
50
60

Fan wheel
50
60

Gebläserad
50
60

Rotor
50
60

118 066 01
118 245 01



Drivkoppling

RSA
AJ
AT
50
RSA
AJ
60

Drive coupling

RSA
AJ
AT
50
RSA
AJ
60

Antriebskupplung

RSA
AJ
AT
50
RSA
AJ
60

Accouplement
d'entraînement

RSA
AJ
AT
50
RSA
AJ
60

118 115 01
118 115 04
118 115 02
118 115 03
118 115 05



Kopplingsdel,
pump
7/16"
RSA, AJ

8 mm
AT
50

Coupling part,
pump
7/16"
RSA, AJ

8 mm
AT
50

Kupplungsstück,
Pumpe
7/16"
RSA, AJ

8 mm
AT
50

Manchon
d'accouplement pompe
7/16"
RSA, AJ

8 mm
AT
50

04 390 448 66
04 390 448 68



Kopplingsände

Coupling part

Kupplungsstück

Manchon
d'accouplement

118 065 01



Motor ATB
0,75kW 3-fas
50
1,1kW 3-fas
60

Motor ATB
0,75kW 3-phase
50
1,1kW 3-phase
60

Motor ATB
0,75kW 3-phasig
50
1,1kW 3-phasig
60

Moteur ATB
0,75kW triphasé
50
1,1kW triphasé
60

420 316 01

420 316 02



Motorkabel
3-fas, 700mm

Cable
3-phase 700mm

Kabel
3-phasig 700mm

Câble
triphase 700mm

119 449 03

B50, B60

MOTOR
MOTOR

MOTOR
MOTEUR

5



Motorfläns
Simel, Dutchi, ATB
50

Flange, motor
Simel, Dutchi, ATB
50

Motorflansch
Simel, Dutchi, ATB
50

Bride, moteur
Simel, Dutchi, ATB
50

118 037 0105



Motorfläns
Simel
60

Flange, motor
Simel
60

Motorflansch
Simel
60

Bride, moteur
Simel
60

118 050 0105



Avskärningskon
50
60

Conical shield
plate
50
60

Abschirmkonus
50
60

Cône déflecteur
d'air
50
60

118 052 01
117 935 01



Motorfläns
ATB
60

Flange, motor
ATB
60

Motorflansch
ATB
60

Bride, moteur
ATB
60











119 737 0105

B50, B60

PUMP PUMP

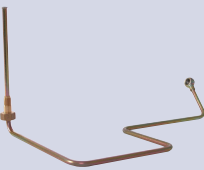
PUMPE POMPE

6

	Pump 50	Pump 50	Pumpe 50	Pompe 50	
	RSA 60	RSA 60	RSA 60	RSA 60	110 197 18
	RSA 95	RSA 95	RSA 95	RSA 95	110 197 23
	Pump 60 RSA 125	Pump 60 RSA 125	Pumpe 60 RSA 125	Pompe 60 RSA 125	110 197 19
	Pump AT365C-2P ersatt av AT365C-4P	Pump AT365C-2P replaced by AT365C-4P	Pumpe AT365C-2P ersetzt durch AT365C-4P	Pompe AT365C-2P remplacée par AT365C-4P	413 675 24
	Pump AT365C-4P 50	Pump AT365C-4P 50	Pumpe AT365C-4P 50	Pompe AT365C-4P 50	120 264 24
	Med kablar	With cables	Mit Kabeln	Avec câbles	920 264 24
	Pump AJ	Pump AJ	Pumpe AJ	Pompe AJ	
	50	50	50	50	113 675 25
	60	60	60	60	113 675 11
	Magnetventilblock komplett Suntec 50-2, 60-2	Solenoid valve bloc complete Suntec 50-2, 60-2	Magnetventilblock komplett Suntec 50-2, 60-2	Jeu d'électrovanne complet Suntec 50-2, 60-2	919 947 01
	Magnetventilblock komplett Suntec 50-3, 60-3	Solenoid valve bloc complete Suntec 50-3, 60-3	Magnetventilblock komplett Suntec 50-3, 60-3	Jeu d'électrovanne complet Suntec 50-3, 60-3	919 947 02
	Förbindelserör magnetventil- insats före 1996 50-2H	Connecting pipe solenoid valve- nozzle assembly before 1996 50-2H	Öldruckrohr Magnetventil - Düsenstock vor 1996 50-2H	Trompette électrovanne - ligne porte-gicleur avant 1996 50-2H	118 129 01
	Förbindelserör II magnetventil- insats före 1996 50-H	Connecting pipe II solenoid valve - nozzle assembly before 1996 50-2H	Öldruckrohr II Magnetventil - Düsenstock vor 1996 50-2H	Trompette II électrovanne - ligne porte-gicleur avant 1996 50-2H	118 130 01
	Magnetventil 1/8" SL1, Suntec 50-1	Solenoid valve 1/8" SL1, Suntec 50-1	Magnetventil 1/8" SL1, Suntec 50-1	Électrovanne 1/8" SL1, Suntec 50-1	121 194 01
	Förbindelserör II pump- reglerdon RSA, AJ före 1996 50-2H	Connecting pipe II pump- adjustment device RSA, AJ before 1996 50-2H	Öldruckrohr II Pumpe- Regelgerät RSA, AJ vor 1996 50-2H	Trompette II pompe- dispositif de réglage RSA, AJ avant 1996 50-2H	118 131 01
	Nippel insats- magnetventil före w9432 50	Nipple nozzle assembly- solenoid valve before w9432 50	Nippel, Düsenstock- Magnetventil vor w9432 50	Raccord, ligne porte-gicleur- électrovanne avant w9432 50	118 183 01

B50, B60

PUMP PUMP

PUMPE POMPE

6

	Förbindelserör pump-reglerdon 60	Connecting pipe pump-adjustment device 60	Öldruckrohr Pumpe-Regelgerät 60	Trompette pompe-dispositif de réglage 60	118 237 01
	Förbindelserör magnetventil-reglerdon 50	Connecting pipe solenoid valve - adjustment device 50	Öldruckrohr Magnetventil-Regelgerät 50	Trompette électrovanne - dispositif de réglage 50	118 622 01
	60	60	60	60	118 428 01
	Nippel, anslutning	Nipple, connection	Nippel, Anschluss	Raccord, adhérence	118 423 01
	Vinkel	Angle	Winkelnippel	Coude	118 404 01
	Kabel, magnetventil, 50-2, 60-2	Cable, solenoid valve 50-2, 60-2	Kabel, Magnetventil 50-2, 60-2	Câble, électrovanne 50-2, 60-2	
	Steg 1 och 2	Stage 1+2	Stufe 1+2	1ère+2ème allures	115 975 03
	Kabel, magnetventil, 50-3, 60-3	Cable, solenoid valve 50-3, 60-3	Kabel, Magnetventil 50-3, 60-3	Câble, électrovanne 50-3, 60-3	
	Steg 1+3	Stage 1+3	Stufe 1+3	1ère+3ème allures	115 975 03
	Steg 2	Stage 2	Stufe 2	2ème allure	115 975 06
	Kopparbricka	Copper gasket	Kupferdichtung	Joint en cuivre	110 212 16
	Magnetventil komplett Suntec 50, 60	Solenoid valve complete Suntec 50, 60	Magnetventil komplett Suntec 50, 60	Électrovanne complet Suntec 50, 60	119 946 01
	Kabel, Danf 900 mm	Cable	Kabel	Câble	115 975 06
	O-ring	O-ring	O-Ring	Rondelle	113 168 02
	Hydraulslang	Hydraulic hose	Hydraulischer Ölschlauch	Tuyau hydraulique	118 293 01

B50, B60

PUMP PUMP

PUMPE POMPE

6

	Magnetventil AT komplett, 50 före April 94	Solenoid valve A complete, 50 before April 94	Magnetventil AT komplett, 50 vor April 94	Électrovanne AT complet, 50 avant Avril 94	915 972 03
	after April 94 Steg 1 NC	after April 94 Stage 1 NC	nach April 94 Stufe 1 NC	après Avril 94 1ère allure, NC	915 972 01
	after April 94 Steg 2 NO	after April 94 Stage 2 NO	nach April 94 Stufe 2 NO	après Avril 94 2ème allure, NO	115 972 04
	Magnetventil, magnetventilblock ersatt av magnetventilblock	Solenoid valve, solenoid valve bloc replaced by solenoid valve bloc	Magnetventil, Magnetventilblock Ersetzt durch Magnetventilblock	Électrovanne, jeu d'électrovanne remplacée par jeu d'électrovanne	415 973 05
	Spole, magnetventilblock ersatt av magnetventilblock	Coil, solenoid valve bloc replaced by solenoid valve bloc	Spule, Magnetventilblock Ersetzt durch Magnetventilblock	Bobine, jeu d'électrovanne remplacée par jeu d'électrovanne	415 974 03
	Spole, Suntec 50, 60 komplett	Coil, Suntec 50, 60 complete	Spule, Suntec 50, 60 komplett	Bobine, Suntec 50, 60 complet	915 971 01
	Spole	Coil	Spule	Bobine	115 971 01
	Filtersats RSA 60	Filter set RSA 60	Filtersatz RSA 60	Jeu de filtre RSA 60	117 832 01
	RSA 90, 125	RSA 95, 125	RSA 95, 125	RSA 95, 125	117 833 01
	Bussning Suntech/Danfoss 50	Bushing Suntech/Danfoss 50	Buchse Suntech/Danfoss 50	Douille Suntech/Danfoss 50	114 113 02
	Filtersats, filter, packningar, o-ring AN,AS,AP,AT,AL-67	Filter kit, filter, gaskets, o-ring	Filter Kit, Filter, Dichtungs, O-Ring	Kit de filtre, filtre, joint, joint torique	114 570 02

B50, B60

ELDNINGSAUTOMAT OIL BURNER CONTROL

FEUERUNGSAUTOMAT COFFRET DE SECURITE 7

	Reläbox LOA24 Industriförpackning	Control box LOA24 Industrial package	Steuergerät LOA24 Industrie verpackung	Boîte de contrôle LOA24 Emballage industriel	115 595 04
	Styckförpackning	Single-piece package	Stückverpackung	Emballage par pièces	915 595 04
	Reläbox LOA44 Industriförpackning	Control box LOA44 Industrial package	Steuergerät LOA44 Industrie verpackung	Boîte de contrôle LOA44 Emballage industriel	115 595 02
	Styckförpackning	Single-piece package	Stückverpackung	Emballage par pièces	915 595 02
	Reläbox LMO24 Industriförpackning	Control box LMO24 Industrial package	Steuergerät LMO24 Industrie verpackung	Boîte de contrôle LMO24 Emballage industriel	120 242 01
	Styckförpackning	Single-piece package	Stückverpackung	Emballage par pièces	920 242 01
	Reläbox TMO 720-4 Industriförpackning	Control box TMO 720-4 Industrial package	Steuergerät TMO 720-4 Industrie verpackung	Boîte de contrôle TMO 720-4 Emballage industriel	04 390 663 18
	Styckförpackning	Single-piece package	Stückverpackung	Emballage par pièces	94 390 663 18
	Reläbox LAL Industriförpackning	Control box LAL Industrial package	Steuergerät LAL Industrie verpackung	Boîte de contrôle LAL Emballage industriel	114 939 01
	Styckförpackning	Single-piece package	Stückverpackung	Emballage par pièces	914 939 01
	Reläsockel LAL	Relay base LAL	Steuergerätsöcket LAL	Socle de raccordement LAL	114 942 00
	Reläsockel TMO	Relay base TMO	Steuergerätsöcket TMO	Socle de raccordement TMO	94390 663 19
	Reläsockel LOA, LMO	Relay base LOA, LMO	Steuergerätsöcket LOA, LMO	Socle de raccordement LOA, LMO	915 596 00

B50, B60

ELDNINGSAUTOMAT OIL BURNER CONTROL

FEUERUNGSAUTOMAT COFFRET DE SECURITE 7

	Kontaktor LC1D09P7	Contacteur LC1D09P7	Kontaktor LC1D09P7	Contacteur LC1D09P7	121 431 01
	Överströmsskydd 1,6-2,5 A 50	Thermal overload protection 1,6-2,5 A 50	Überstromschutz 1,6-2,5 A 50	Déclencheur à maxima d'intensité 1,6-2,5 A 50	121 432 06
	2,5-4,0 A 50	2,5-4,0 A 50	2,5-4,0 A 50	2,5-4,0 A 50	121 432 03
	Indikeringslampa grön	Indicating lamp green	Anzeigelampe Grün	Lampe témoin Verte	117 211 03
	Strömbrytare I-II	Switch I-II	Schalter I-II	Interrupteur I-II	120 149 02
	0-I	0-I	0-I	0-I	120 149 01
	Kabelgenomföring	Cable inlet	Kabeldurchführung	Douille de passage de câble	118 100 01
	Timräknare	Time meter	Betriebsstunden- zähler	Compteur horaire	117 678 01
	Säkring 6.3A	Fuse 6.3A	Sicherung 6.3A	Fusible 6.3A	113 332 01
	Säkringshållare komplett	Fuse holder complete	Sicherungshalter komplett	Support de fusée complet	118 118 03

B50, B60

ELDNINGSAUTOMAT OIL BURNER CONTROL

FEUERUNGSAUTOMAT COFFRET DE SECURITE 7

	Fläns, fotomotstånd QRB1	Flange, photoresistor QRB1	Flansch, Fotowiderstand QRB1	Bride, cellule photorésistante QRB1	112 405 01
	Fotomotstånd QRB1-A	Photoresistor QRB1-A	Fotowiderstand QRB1-A	Cellule photorésistante complete. QRB1-A	04 390 295 68
	Fotomotstånd FZ711G rød	Photoresistor FZ711G red	Fotowiderstand FZ711G rot	Cellule photorésistante FZ711G rouge	912 409 08
	Fläns, fotomotstånd låg FZ	Flange, photoresistor low FZ	Flansch, Fotowiderstand niedrig FZ	Bride, cellule photorésistante bas FZ	00 390 113 02
	Kontakttonssats 5+7+4 pol	Plug-in contact kit 5+7+4-pole	Stecker und Buchsenteilsatz 5+7+4-polig	Fiche de Prise de courant 5+7+4-polaire	119 486 01
	7 pol, hona	female 7-pole	Buchsenteil 7-polig	femelle, 7-polaire	115 586 03
	7 pol, hane	male 7-pole	Steckerteil 7-polig	mâle, 7-polaire	115 585 00
	4 pol, hane Grön	male 4-pole Green	Steckerteil 4-polig Grün	mâle, 4-polaire Verte	119 197 01
	4 pol, hane Svart	male 4-pole Black	Steckerteil 4-polig Schwartz	mâle, 4-polaire Noir	119 103 01
	4 pol, hona Grön	female 4-pole Green	Buchsenteil 4-polig Grün	femelle, 4-polaire Verte	119 198 01
	4 pol, hona Svart	female 4-pole Black	Buchsenteil 4-polig Schwartz	femelle, 4-polaire Noir	119 104 01
	5 pol, hane	male 5-pole	Steckerteil 5-polig	mâle, 5-polaire	119 199 01
	5 pol, hona	female 5-pole	Buchsenteil 5-polig	femelle, 5-polaire	119 200 01
	Kontakttonssats 5+7+4+4 pol 50-3, 60-3	Plug-in contact kit 5+7+4+4-pole 50-3. 60-3	Stecker und Buchsenteilsatz 5+7+4+4-polig 50-3. 60-3	Fiche de Prise de courant 5+7+4+4 50-3. 60-3	119 486 10

B50, B60

TRANSFORMATOR TRANSFORMER

TRANSFORMATOR TRANSFORMATEUR

8



Transformator
kontinuerlig tändning

Transformer
continuous ignition

Transformator
kontinuierliche
Zündung

Transformateur
allumage continu

118 046 02



Transformator
Kabel 700mm
50

Transformer
Cable 700mm
50

Transformator
Kabel 700mm
50

Transformateur
Câble 700mm
50

118 046 01

118 047 02



Transformator
220V 2,3A
2x6kW

Transformer
220V 2,3A
2x6kW

Transformator
220V 2,3A
2x6kW

Transformateur
220V 2,3A
2x6kW

917 456 03

Kabel 450mm
60

Cable 450mm
60

Kabel 450mm
60

Câble 450mm
60

119 771 01



Tändkabel
500mm
60

Ignition cable
500mm
60

Zündkabel
500mm
60
330mm
50

Câble d'allumage
500mm
60
330mm
50

119 337 06

330mm
50

330mm
50

119 337 02



Tändkabel,
skruvkoppling
330mm
60

Ignition cable
screw fitting
330mm
60

Zündkabel
Schraubekopplung
330mm
60

Câble d'allumage
Brancher visser
330mm
60

118 305 02

Metervara

By-the-meter

Meterware

Marchandise
métrique

279 361 00



Rajakoppling

Rajah coupling

Rajahkupplung

Accouplement Rajah



Kabelgenomföring

Cable inlet

Kabeldurchführung









Douille de passage
de câble

115 898 02

B50, B60

LUFTREGLERING AIR REGULATION

LUFTREGELUNG RÉGULARISATION À AIR 9

	Luftspjäll komplett 50-2H, 50-1	Air damper complete 50-2H, 50-1	Luftklappe komplett 50-2H, 50-1	Volet d'air complet 50-2H, 50-1	917 992 01
	Luftspjäll komplett 50-2	Air damper complete 50-2	Luftklappe komplett 50-2	Volet d'air complet 50-2	917 992 02
	Luftspjäll komplett 60-2H	Air damper complete 60-2H	Luftklappe komplett 60-2H	Volet d'air complet 60-2H	918 241 01
	Luftspjäll komplett 60	Air damper complete 60	Luftklappe komplett 60	Volet d'air complet 60	918 240 01
	Mät nipple	Test nipple	Messnippel	Raccord de mesure	118 053 01
	Länkarm komplett	Slewing bracket complete	Gelenkarm komplett	Pivot complet	119 470 01
	Fästplatta, spjällmotor 50	Covering plate, servo motor 50	Deckplatte, Stellmotor 50	Plaque de fixer, servomoteur 50	117 978 0105
	Fästplatta, spjällmotor 60	Covering plate, servo motor 60	Deckplatte, Stellmotor 60	Plaque de fixer, servomoteur 60	118 239 0105
	Fästplatta, spjällmotor 50-2H 60-2H	Covering plate, servo motor 50-2H 60-2H	Deckplatte, Stellmotor 50-2H 60-2H	Plaque de fixer, servomoteur 50-2H 60-2H	118 528 0105 118 401 0105

B50, B60

LUFTREGLERING AIR REGULATION

LUFTREGELUNG RÉGULARISATION À AIR 9

	Pinnskruv 50-2H, 60-2H	Stud screw 50-2H, 60-2H	Stiftschraube 50-2H, 60-2H	Vis à goupille 50-2H, 60-2H	119 203 01
	Ändavslutning	End piece	Endstück	Pièce d'extrémité	118 103 01
	Spjällmotor ersatt av SQN	Servo motor replaced by SQN	Stellmotor ersätzt durch	Servo moteur remplacée par SQN	917 053 03
	LKS 160-15 2-steg, LAL	LKS 160-15 2-stage, LAL	LKS 160-15 2-stufig, LAL	LKS 160-15 2 allures, LAL	917 053 02
	LKS 160-17 3-steg, LAL	LKS 160-17 3-stage, LAL	LKS 160-17 3-stufig, LAL	LKS 160-17 3 allures, LAL	917 053 08
	LKS 160-56 2-steg, TMO	LKS 160-56 2-stage, TMO	LKS 160-56 2-stufig, TMO	LKS 160-56 2 allures, TMO	
	Spjällmotor	Servo motor	Stellmotor	Servo moteur	
	SQN75.294A21B 2-steg, LAL	SQN75.294A21B 2-stage, LAL	SQN75.294A21B 2-stufig, LAL	SQN75.294A21B 2-allures, LAL	119 423 03
	SQN75.436A21B 3-steg, LAL	SQN75.436A21B 3-stage, LAL	SQN75.436A21B 3-stufig, LAL	SQN75.436A21B 3-allures, LAL	119 423 01
	SQN75.244A21B 2-steg, LOA, LMO 50	SQN75.244A21B 2-stage, LOA, LMO 50	SQN75.244A21B 2-stufig, LOA, LMO 50	SQN75.244A21B 2-allures, LOA, LMO 50	119 423 04
	SQN75.215A21B 2-steg, TMO	SQN75.215A21B 2-stage, TMO	SQN75.215A21B 2-stufig, TMO	SQN75.215A21B 2-allures, TMO	119 423 08

B50, B60

LUFTREGLERING AIR REGULATION

LUFTREGELUNG RÉGULARISATION À AIR 9

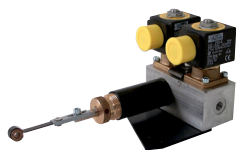

Reglerdon
före 1996
50-2H

Adjustment device
before 1996
50-2H

Regelgerät
vor 1996
50-2H

Dispositif de réglage
avant 1996
50-2H

118 120 01



Magnetventil
före 1996
50-2H

Solenoid valve
before 1996
50-2H

Magnetventil
vor 1996
50-2H

Électrovanne
avant 1996
50-2H

914 967 02



Reglerdon
50-2H, 60-2H

Adjustment device
50-2H, 60-2H

Regelgerät
50-2H, 60-2H

Dispositif de réglage
50-2H, 60-2H

917 565 03



Fjäder,
reglerdon
50-2H, 60-2H

Spring,
adjustment device
50-2H, 60-2H

Feder,
Regelgerät
50-2H, 60-2H

Ressort,
dispositif de
réglage
50-2H, 60-2H

113 799 01



Packningssats,
reglerdon
50-2H, 60-2H

Gasket set,
adjustment device
50-2H, 60-2H

Dichtungssatz,
Regelgerät
50-2H, 60-2H









Jeu de joint,
dispositif de réglage
50-2H, 60-2H

118 322 02

B50, B60

FLÄKTHUS FAN HOUSING

BRENNERGEHÄUSE CARTER DU ROTOR 10

	Säkringsring	Locking ring	Sicherungsring	Anneau de fusible	118 018 01
	Inspektionsglas	Inspection glass	Schauglas	Viseur de flamme	118 088 01
	Packning	Gasket	Dichtung	Joint	117 953 01
	Skyddsgaller 50	Protective grating 50	Schutzgitter 50	Grille de protection 50	117 949 01 118 319 01
	Skyddsgaller 60	Protective grating 60	Schutzgitter 60	Grille de protection 60	117 951 0105
	Lock 50	Cover 50	Deckel 50	Couvercle 50	118 238 0105
	Packning 60	Gasket 60	Dichtung 60	Joint 60	118 249 01
	Kåpa, inspektionsglas 50	Cover, inspection glass 50	Haube, Schauglas 50	Capot, viseur de flamme 50	117 963 0205
	Kåpa, inspektionsglas 60	Cover, inspection glass 60	Haube, Schauglas 60	Capot, viseur de flamme 60	118 242 0105

B50, B60

FLÄKTHUS
FAN HOUSING

BRENNERGEHÄUSE
CARTER DU ROTOR 10



Inspektionslock

Inspection cover

Deckel Schauglas

Couvercle,
viseur de flamme

117 080 01

B50, B60

ÖVRIGT SUNDRIES

VERSCHIEDENES DIVERS

10



Oljeslang
1500 mm
2500 mm

Flexible pipe
1500 mm
2500 mm

Ölschlauch
1500 mm
2500 mm

Flexible
1500 mm
2500 mm

113 542 08
113 542 06



Oljefilter
1/2"

Oil filter
1/2"

Ölfiter
1/2"

Filtre de mazout
1/2"

114 293 04



Filterinsats

Filter

Filter

Filtre

114 314 03



Packningssats,
Oljefilter

Gasket set,
Oil filter

Dichtungssatz,
Ölfiter

Jeu de joint.
Filtre d'huile

118 853 03



CTC AB Box 309 SE-341 26 Ljungby

info@bentone.se +46 372 88 000

www.bentone.se