



Providing sustainable energy solutions worldwide

Installation- and maintenance instruction

ST 120 KA

LMO14.113C2E

AS47CK



-sv

1. Manualer på övriga språk

2. www.bentone.com\
nedladdning eller scanna
QR-koden.

3. Skriv in brännarens
artikelnummer som finns på
din typskylt (se bild) och välj
ditt språk.

Detaljerad ecodesign
information kan laddas ner
på: [www.bentone.com/
ecodesign](http://www.bentone.com/ecodesign).

-fr

**1. Manuels dans d'autres
langues**

2. www.bentone.com\
download ou scannez le
code QR.

3. Saisir le numéro d'article
du brûleur sur votre plaque
signalétique (consultez
l'illustration) et sélectionnez
la langue.

Des informations détaillées
sur l'ecodesign peuvent être
téléchargées à l'adresse:
[www.bentone.com/
ecodesign](http://www.bentone.com/ecodesign).

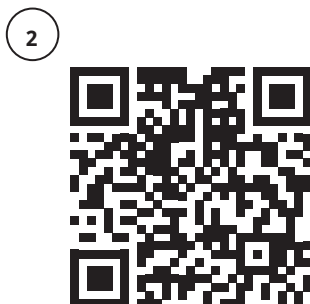

-en

1. Manuals in other languages

2. www.bentone.com\
download or scan QR-code.

3. Enter the burner`s article
number on your data plate
(see picture) and select
language.

Detailed ecodesign
information can be
downloaded at:
[www.bentone.com/
ecodesign](http://www.bentone.com/ecodesign).

-de

**1. Gebrauchsanweisungen in
anderen Sprachen**



2. www.bentone.com\
download oder scannen Sie
den QR-Code.

3. Geben Sie die
Artikelnummer des Brenners
auf Ihrem Typenschild ein,
(siehe Bild) und wählen Sie
die Sprache aus.

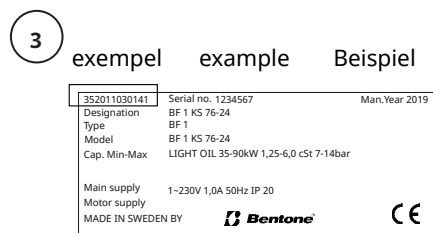
Detaillierte Informationen
zum Ecodesign können unter
www.bentone.com/ecodesign
heruntergeladen werden.



3 exempel example Beispiel

352011030141	Serial no. 1234567	Man.Year 2019
Designation	BF 1 KS 76-24	
Type	BF 1	
Model	BF 1 KS 76-24	
Cap. Min-Max	LIGHT OIL 35-90kW 1,25-6,0 cSt 7-14bar	
Main supply	1-230V 1,0A 50Hz IP 20	
Motor supply		
MADE IN SWEDEN BY		

-da

1. Manualer på andre sprog

2. www.bentone.com\
download eller scan
QR-koden.

3. Indtast brænderens
artikelnummer, der findes
på typeskiltet (se billede), og
vælg dit sprog.

Detaljerede oplysninger om
ecodesign kan downloades
på: [www.bentone.com/
ecodesign](http://www.bentone.com/ecodesign).

Table of contents

1. General Information.....	4	6. Pump	20
1.1 Delivery inspection.....	4	6.1 SUNTEC AS	20
1.2 Safety	4	7. Service	26
2. Technical data.....	6	7.1 Burner Service Schedule, Oil	26
2.1 Dimensions ST 120 KA	6	7.2 Component replacement intervals.....	26
2.2 Working field	7	7.3 Combustion device	27
2.3 Basic settings	7	7.4 Replacing the preheater	28
2.5 Setting of ignition electrodes and brake plate.....	8	7.5 Replacing the oil pump.....	29
2.4 Technical specification	8	7.6 Replacing the fan motor and fan wheel.....	30
2.6 Nozzle and pump pressure.....	9	7.7 Air intake and intake cone.....	31
2.7 Nozzle table.....	9	7.8 Replacing the entire electrical package	31
2.8 Components.....	10	7.9 Replacing individual electrical package components	32
3. Installation.....	11	8. Fault Location.....	33
3.1 General instructions	11	8.1 Burner will not start.....	33
3.2 Inspection and maintenance.....	11	8.2 Burner will not start after normal use	33
3.3 Start-up	11	8.3 Delayed ignition	34
3.4 Delivery inspection.....	11	8.4 Noise in pump	34
3.5 Preparing for installation.....	11	8.5 Pump pressure	35
3.6 Oil distribution	12	9. Log of flue gas analysis	36
3.7 Electrical connection	12		
3.8 Mounting	13		
4. Settings	14		
4.1 Example of basic setting.....	14		
5. Electric equipment.....	16		
5.1 Safety system	16		
5.2 Wiring diagram	17		
5.3 Function LMO14/24.....	18		
5.4 Colour codes LMO14/24.....	19		
5.5 Fault codes LMO14/24.....	19		

1. General Information

The burner may only be used for its intended purpose in accordance with the product's technical data.

We reserve the right to make design changes and cannot be held liable for any misprints or typographical errors.

Modifying the design or using accessories or components that have not been approved by Enertech in writing is strictly prohibited.

This Installation and Maintenance manual:

- is to be regarded as part of the burner and must always be kept near the installation site.
- must be read prior to installation.
- is intended for use by authorised personnel.

1.1 Delivery inspection

- Make sure everything is delivered and the goods have not been damaged during transit. Transport damage must be reported to the shipping company.
- If something is wrong with a delivery, report it to the supplier.

1.2 Safety

- before installation:

- Installation and work on the burner and associated system components may only be carried out by persons who have undergone relevant training.
- The product is packaged to prevent damage from occurring when handled – Handle the product with care! Lifting equipment must be used to lift larger packages.
- The products must be transported/stored on a level surface in a dry environment, max. 80% relative humidity, no condensation. Temperature -20 to +60 °C.



- installation:

- The burner must be installed in accordance with local regulations for fire safety, electrical safety, and fuel distribution.
- The premises must comply with local regulations pertaining to use of the burner, and must have adequate air supply.
- The installation site must be free of chemicals.
- Fire extinguisher with Class BE recommended.
- Make sure when installing the burner that there is enough space to service the burner.
- The electrical installation must be professionally carried out in accordance with current mains electricity regulations and in a professional manner.
- Make sure that the burner is suitable for the application (see Technical Data).
- All components must be installed without being bent, twisted or subjected to mechanical or thermal forces that affect components.

- Care must be taken by the installer to ensure that no electrical cables or fuel lines are pinched or otherwise damaged during installation or service.
- Flame tubes, fan wheels and air dampers, for example, may contain sharp edges.

- before first start:

- The burner must not be put into operation without proper safety and protection devices.
- Permitted ambient temperature during operation -10 to +60 °C. Max. 80% relative humidity, no condensation.
- The surface temperature of the burner's components may exceed 60 °C.
- Handle with caution – the burner has moving parts, and there is risk of crushing injuries.
- Seal inspections must be performed during installation and servicing to prevent leakage.
- fitting and installation work has been completed and approved.
- electrical installation has been correctly performed.
- flue gas ducts and combustion air ducts are not blocked.
- all actuators and control and safety devices are in working order and correctly set.
- If the boiler is equipped with an access hatch, this must be equipped with a hatch opening switch connected to the burner's safety system.
- When in operation, the burner's noise level can exceed 85 dBA – use hearing protection!



- Operation:

- Carry out all stipulated settings, service and inspection work within the set time.
- If the oil burner control has a solid red light, contact your installer.

2. Technical data

The burner is intended for:

- Operation in installations according to EN 303 and EN 267.
When operating with a hot air boiler, the LMO24.255 or LMO44.255 control unit must be used.

Fuels:

- Fuel oil according to DIN 51603-1.
- Fuel oil A Bio 10 according to DIN 51603-6.

2.1 Dimensions ST 120 KA

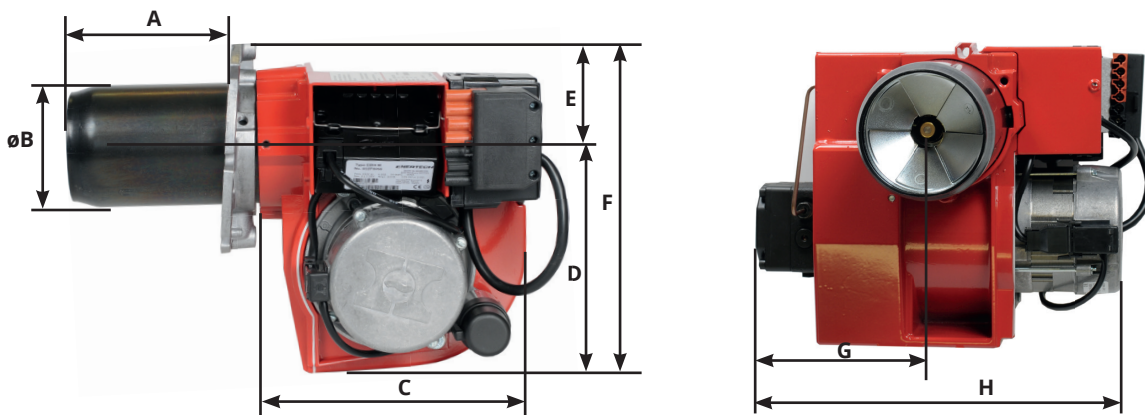

Length of flame tube	Measurement A	
	Flange 1	Flange 2
94	76	60
147	129	113

Ø B	C	D	E	F	G	H	*I
89	194	169	54	229	148	275	200

* Min. recommended distance to floor.

2.1.1 Dimensions, flanges

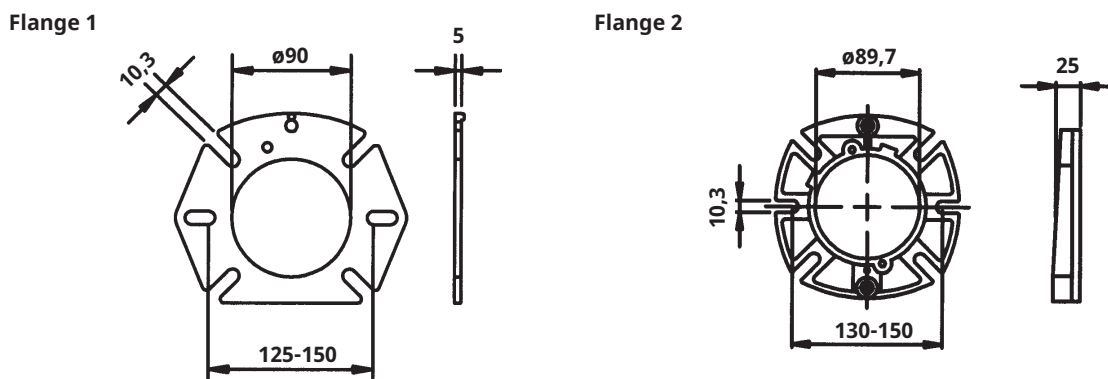

165 205 18-3

2.1.2 Hole patten

Make sure the hole pattern on the boiler is designed for burner flange.

d1	d2	d3
ø 90	10	ø 125-150

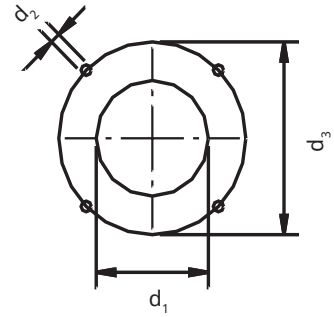

2.2 Working field

2.0-5.6 kg/h
24-66 kW

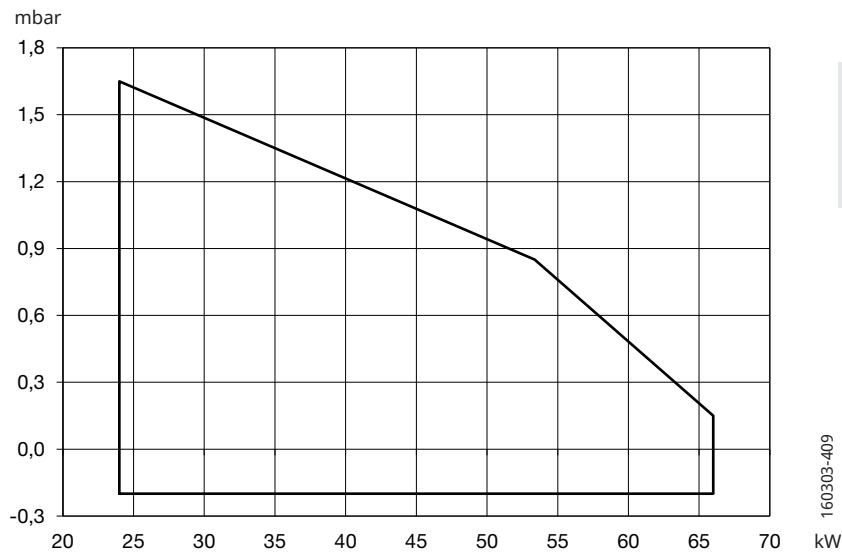

! Do not exceed the working area.

2.3 Basic settings

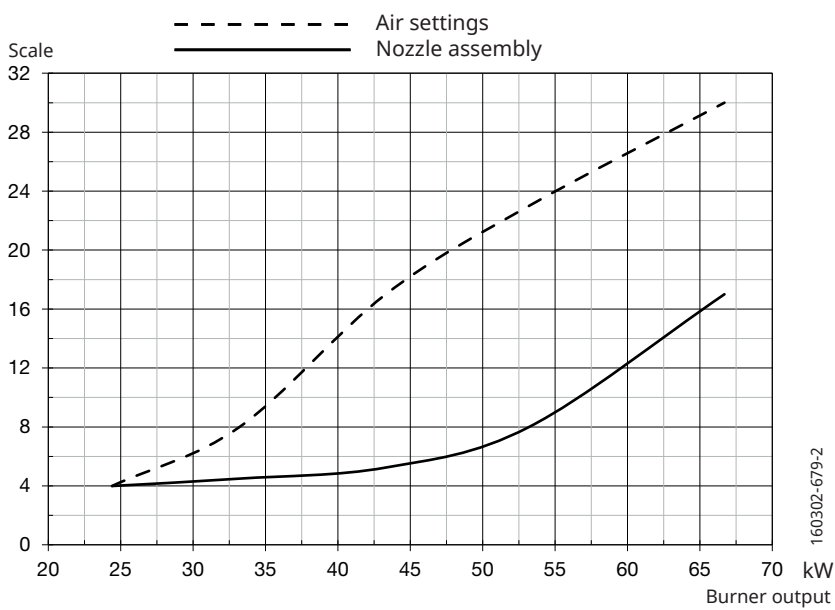

2.4 Technical specification

ST 120	
Main supply ¹⁾	230V, 1~, 1.0/1.5A, 50Hz, IP20
Max fuse rating	8A
EI _{min} preheater excluded	0.61A, 139W
EI _{max} preheater excluded	0.66A, 150W
P _{SB}	0
NO _x -class	2
Noise level	74dBA

¹⁾ Max operating current, see data plate.

Measurements according to EN 15036-1:2006

Alt.1 The noise level of the burner can be reduced by equipping the burner with silencer. Installation must be done so it does not prevent air supply to the burner.

Alt.2 The burner's noise level can be reduced by connecting the burner's air intake to the air duct that opens into an appropriate location. Installation must be done so it does not prevent air supply to the burner.

2.5 Setting of ignition electrodes and brake plate

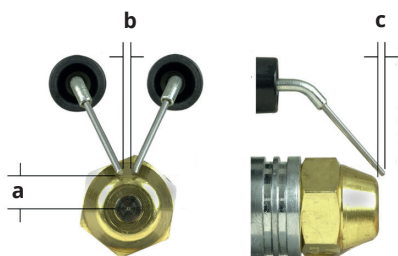

a	b	c
8,0-9,0	2,7-3,3	0,5-1,5

! *NB It is important that the spark does not strike against the brake plate or nozzle

2.6 Nozzle and pump pressure

Due to different furnace geometries and capacities, it is not possible to recommend a nozzle model.

Nozzle	60° Solid/Hollow cone 80° Solid/Hollow conel
Pump pressure	10 bar (8–14 bar) Fuel oil 1 10 bar (7–12 bar) Kerosene

2.7 Nozzle table

Gph	Pump pressure, bar																	
	7		8		9		10		11		12		13		14		15	
	kg/h	kW	kg/h	kW	kg/h	kW	kg/h	kW	kg/h	kW	kg/h	kW	kg/h	kW	kg/h	kW	kg/h	kW
0,35	1,13	13	1,21	14	1,28	15	1,35	16	1,42	17	1,48	17	1,54	18	1,60	19	1,65	19
0,40	1,22	14	1,33	16	1,41	17	1,49	18	1,56	18	1,63	19	1,70	20	1,76	21	1,82	21
0,50	1,56	18	1,66	20	1,76	21	1,86	22	1,95	23	2,04	24	2,12	25	2,20	26	2,28	27
0,60	1,98	23	2,00	24	2,12	25	2,23	26	2,34	28	2,45	29	2,55	30	2,64	31	2,73	32
0,65	2,23	26	2,16	26	2,29	27	2,42	29	2,54	30	2,65	31	2,75	33	2,86	34	2,96	35
0,75	2,46	29	2,49	29	2,65	31	2,79	33	2,93	35	3,08	36	3,18	38	3,30	39	3,42	40
0,85	2,77	32	2,83	33	3,00	36	3,16	37	3,32	39	3,47	41	3,61	43	3,74	44	3,87	46
1,00	3,11	37	3,33	39	3,53	42	3,72	44	3,90	46	4,08	48	4,24	50	4,40	52	4,56	54
1,10	3,55	42	3,66	43	3,88	46	4,09	48	4,29	51	4,48	53	4,67	55	4,84	57	5,01	59
1,20	3,72	44	3,99	47	4,24	50	4,47	53	4,68	55	4,89	58	5,09	60	5,29	63	5,47	65
1,25	3,94	47	4,16	49	4,40	52	4,65	55	4,88	58	5,10	60	5,30	63	5,51	65	5,70	68
1,35	4,33	51	4,49	53	4,76	56	5,02	59	5,27	62	5,50	65	5,73	68	5,95	70	6,15	73
1,50	4,89	58	4,98	59	5,29	63	5,58	66	5,85	69	6,11	72	6,36	75	6,60	78	6,83	81
1,65	5,09	60	5,49	65	5,82	69	6,14	73	6,44	76	6,73	80	7,00	83	7,27	86	7,52	89
1,75	5,48	65	5,82	69	6,18	73	6,51	77	6,83	81	7,14	85	7,42	88	7,71	91	7,97	94
2,00	6,21	74	6,65	79	7,06	84	7,45	88	7,81	93	8,18	97	8,49	101	8,81	104	9,12	108
2,25	6,99	83	7,49	89	7,94	94	8,38	99	8,78	104	9,18	109	9,55	113	9,91	117	10,26	122
2,50	7,77	92	8,31	98	8,81	104	9,29	110	9,74	115	10,18	121	10,59	126	10,99	130	11,38	135
2,75	8,78	104	9,39	111	9,96	118	10,50	124	11,01	131	11,50	136	11,97	142	12,42	147	12,86	152
3,00	9,71	115	10,38	123	11,00	130	11,60	137	12,17	144	12,71	151	13,23	157	13,73	163	14,21	168
4,00	11,88	141	12,70	150	13,47	160	14,20	168	14,89	176	15,56	184	16,19	192	16,80	199	17,39	206

The table applies to oils with a viscosity of 4.4 mm²/s (cSt) at a density of 830 kg/m³.

2.7.1 Burner with preheater

Allow for a reduction in oil quantity of 5–20% with preheating owing to:

- Temperature increases at the nozzle.
- Nozzle design.
- Capacity (the higher the capacity the lower the difference).

2.8 Components

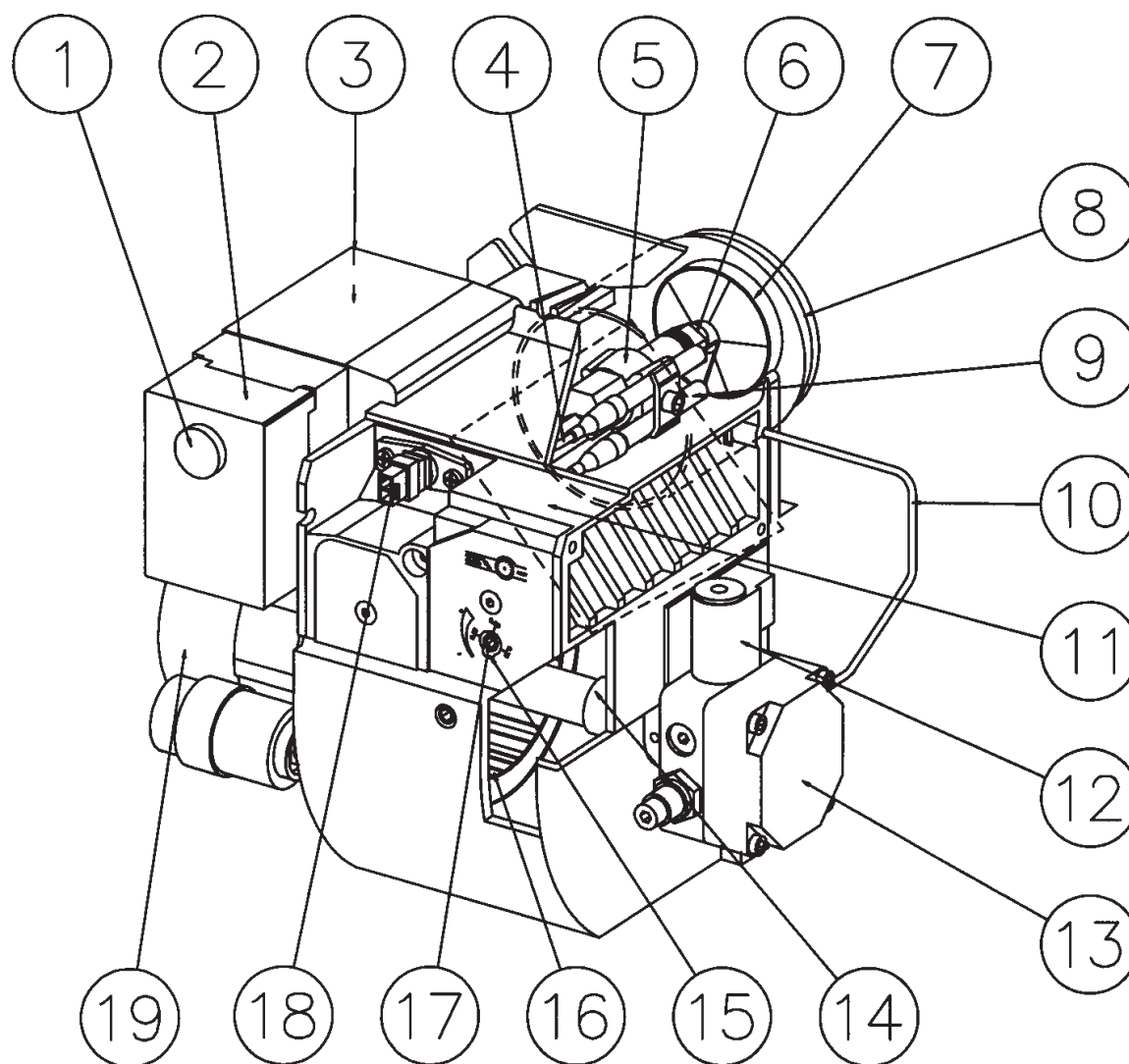

- | | | |
|-------------------------|------------------------|----------------------------|
| 1. Reset button | 8. Flame tube | 15. Indication, air damper |
| 2. Control box | 9. Ignition electrodes | 16. Fan wheel |
| 3. Ignition transformer | 10. Connecting pipe | 17. Adjustment, air damper |
| 4. Ignition cables | 11. Air damper | 18. Photoresistor |
| 5. Nozzle assembly | 12. Solenoid valve | 19. Motor |
| 6. Nozzle | 13. Pump | |
| 7. Brake plate | 14. Drive coupling | |

3. Installation

3.1 General instructions

Oil burners must be installed in accordance with local regulations. The installer must therefore be knowledgeable of the regulations pertaining to oil and combustion.

Only oil suitable for the burner must be used and then in combination with a suitable oil filter installed before the burner's oil pump.

If the burner is replacing an existing burner, ensure that the oil filter is replaced or cleaned. Installation may only be performed by qualified personnel.

Care should be taken by the installer to ensure that electrical cables and oil lines are not pinched or otherwise damaged during installation or servicing.

3.2 Inspection and maintenance

The system must be maintained at the interval specified in the service schedule. If the burner is in a dirty environment, service should be done at more frequent intervals.

3.3 Start-up

In order to obtain the correct setting, a flue gas analysis and temperature measurement must be carried out. Otherwise, there is a risk of soot build up, poor efficiency or condensation in the chimney. The system must be fine-tuned at start-up. The temperature in the chimney at a depth of 0.5 m must be at least 60 °C to prevent condensation.

3.4 Delivery inspection

Make sure everything is delivered and the goods have not been damaged during transit. If something is wrong with a delivery, report it to the supplier. Transport damage must be reported to the shipping company.

3.5 Preparing for installation

Check that the burner's dimensions and capacity range are suitable for the relevant boiler. The power data on the rating plate refers to the burner's minimum and maximum power.

3.6 Oil distribution

In order to achieve good reliability, it is important that the oil distribution system is designed correctly.

Take the following into account:

- Selection of pipe diameter, pipe length and height difference; see Pump instruction.
- Pipelines are to be laid with the fewest possible number of glands.
- The pipes are to be laid so that the oil supply hoses are not subjected to tensile stresses or become excessively bent when the burner is swung out or removed for servicing.
- The oil filter should be installed so that the filter cartridge can easily be replaced or cleaned.
- Parts in contact with oil must be selected in materials that are capable of withstanding the medium's physical properties.
- When installing oil hoses, check that the inlet and return hoses are fitted to the appropriate connection on the oil pump. The hoses must be located so that they do not bend or become subject to tensile load.
- Bleed the oil system. The oil pump/oil preheater may be damaged if run dry. The vacuum in the suction line should not fall below 0.3 bar during start-up.

3.7 Electrical connection

- Before work on the electrical connection, the current must be disconnected so that the installation is isolated.
- Electrical connection must be done in accordance with the applicable regulations.
- Burners must be connected to an all-pole switch.
- Connection must conform to the wiring diagram.
- Use appropriately sized fuses.

 The oil filter must be installed before the burner's oil pump.

 Be sure to fill the burner oil system before starting it for the first time.

 If any electrical connection is used other than that recommended by Enertech, there may be a risk of damage to property and personal injury.

3.8 Mounting

3.8.1 Hole pattern

Make sure the hole pattern on the burner corresponds to the supplied flange, (see Technical data).

3.8.2 Burner installation

1. Install the flange with gasket on the boiler.
2. Fit the selected nozzle, (see Technical data).
3. Install the brake plate and check the ignition electrodes, (see Burner Servicing).
4. Mount the burner to the flange.
5. Insulate between the burner and boiler door to reduce radiated heat (if necessary).

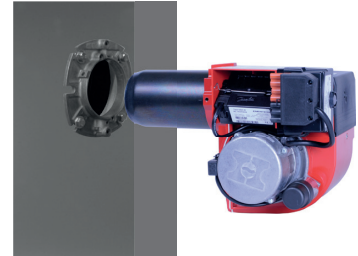

3.8.3 Oil lines

1. Check the dimensions of the oil lines, (see Pump instructions).
2. The oil filter should be fitted to the incoming oil line. If a degasser is installed, the oil filter should be fitted to the oil line up to the degasser in order to prolong the service life of the oil filter.
3. For single pipe systems, the return plug must be removed, (see Pump instructions).
4. When installing oil hoses, check that the supply and return hoses are fitted to the appropriate connection on the oil pump. The hoses must be located so that they do not bend or become subject to tensile load.
5. Bleed the oil system. Dry running will damage the oil pump.
6. The vacuum in the suction line should not fall below 0,3 bar during start-up.

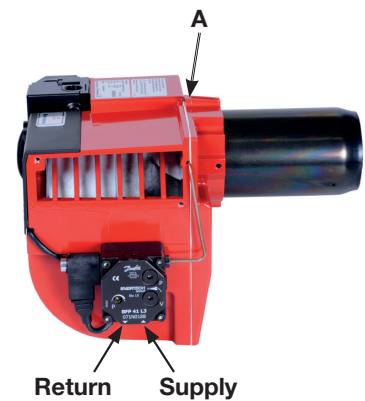

3.8.4 Electrical connection

If the boiler does not have a pre-fitted connector, connect to the supplied connectors (x2) as shown in the wiring diagram.

1. Switch off the main switch.
2. Connect the Europlugs (x2) as shown in the wiring diagram.
3. Fit the Europlugs (x2) to the burner.
4. Turn on the main switch.

3.8.5 Check oil line seals

Once the burner has been installed and commissioned, the seals of the various coupling elements should be checked.

When a leak is detected, it is usually sufficient to tighten the coupling element that is leaking.



4. Settings

4.1 Example of basic setting

ST 120 KA 76-22

Burner output:	48 kW
Estimated nozzle output:	$48 / 11.86^* = 4.05 \text{ kg/h}$

(* Calorific value Fuel oil = 11.86 kWh/kg)

This provides the following nozzle according to the nozzle table, (see Technical data).

Nozzle:	1.10 Gph
Pump pressure:	10.0 bar

Setting values for 48 kW according to basic setting diagram, (see Technical data).

Air setting:	=	20.0
Insert setting:	=	6.0

4.1.1 Insert control

The burner is equipped with a lever that changes the position of the brake plate in the burner tube. This is used to set the correct pressure drop across the combustion assembly, thereby obtaining good combustion without pulsation.

The setting to be used depends on, among other things, the output settings and overpressure in the boiler.

Setting the brake plate

- Small column: turn the screw left.
- Large column: turn the screw right.

Setting the brake plate position affects airflow. Therefore, it is always necessary to fine-tune airflow using the burner's airflow regulator.

4.1.2 Air intake adjustment

Setting the air intake is very important to achieve good combustion with neither too much nor too little air. To adjust the combustion airflow, turn the airflow regulator lever using an Allen key. The extent to which the airflow lever must be open is determined by the heat output and overpressure in the boiler as well as other settings on the burner such as the position of the brake plate.

4.1.3 Setting the air quantity

Turn the air intake clockwise to increase airflow and anticlockwise to decrease airflow.

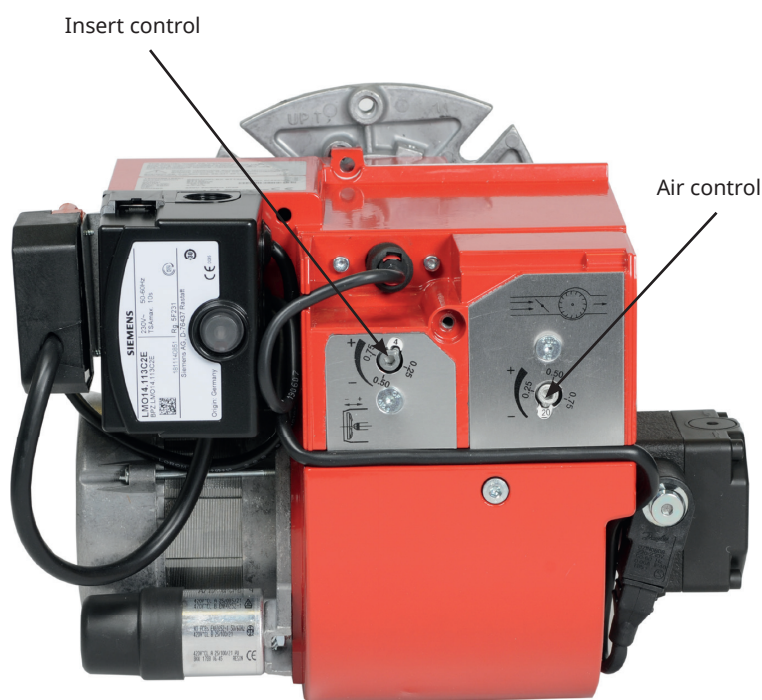

5. Electric equipment

5.1 Safety system

The safety system (safety switch for hatches, doors, water level, pressure, temperature and other safety devices) must be installed in the safety circuit in accordance with current regulations for the system.

The cables of the safety system must be separated so that the outgoing signal is not placed in the same cable as the incoming signal.

5.2 Wiring diagram

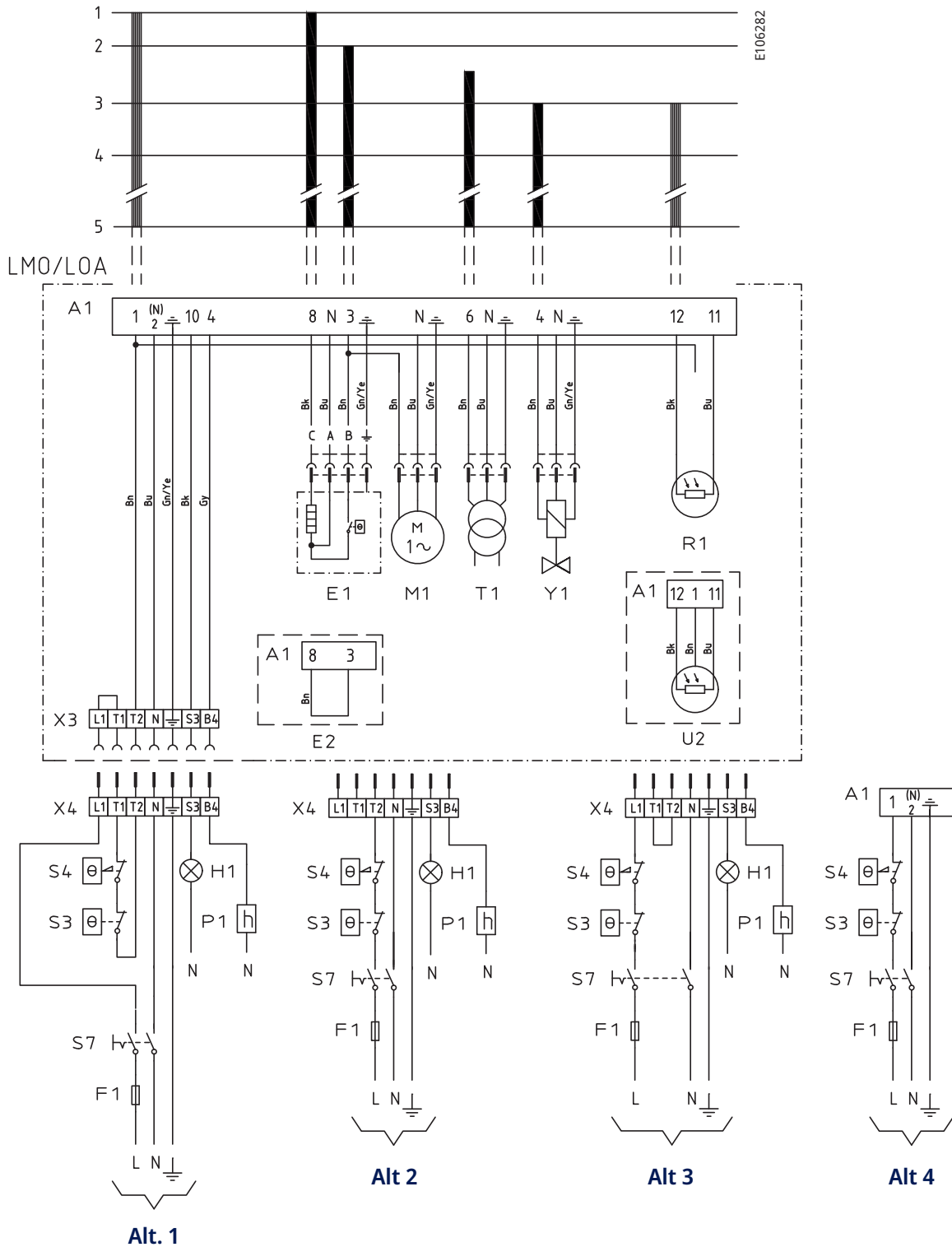

Alt. 1

EnI DIN 4791

Bn	Brown
Bu	Blue
Gn/Ye	Ground/Yellow
Bk	Black
Gy	Grey

5.2.1 List of components

A1	Oil burner control	U2	UV-cell QRC
E1	Preheater	S3	Control thermostat
E2	Burner without preheater	S4	Temperature limiter
F1	Fuse max. 10 A	S7	Main switch
H1	Lamp, low capacity	T1	Ignition transformer
M1	Burner motor	Y1	Solenoid valve
P1	Time meter, low capacity (optinal)	X3	Plug-in contact, burner
R1	Flame detector QRB	X4	Plug-in contact, boiler

5.3 Function LMO14/24

1 Switch on operating switch and twin thermostat

A spark is formed. The air damper motor opens the damper to low load position. The burner motor starts, the prepurge goes on till the prepurge period expires and the solenoid valve 1 opens (2).

2. Solenoid valve 1 opens

Oil mist is formed and ignited. The photocell indicates a flame. The ignition spark goes out after flame indication (See Technical data oil burner control).

3. The safety time expires

a If no flame is established before this time limit the control cuts out.

b If for some reasons the flame disappears after this time limit, the burner will make an attempt to re-start.

4 High/Low thermostat ON

The burner is in operating position and can now change between full load and low load.

4-5 Operating position

If the burner operation is interrupted by means of the main switch or the thermostat, a new start takes place when the conditions in accordance with point 1 are fulfilled.

The oil burner control cuts out

A red lamp in the control is lit. Press the reset button and the burner re-starts.

! Mains connection and fuse in accordance with local regulations.

5.3.1 Technical data

	LMO14.113...	LMO24.255...
Preignition time	15 s	25 s
Prepurge time	16 s	26 s
Postignition time	3 s	5 s
Safety lockout time	< 10 s	< 5 s
Reset time after lockout	< 1 s	< 1 s
Reaction time on flame failure	< 1 s	< 1 s
Ambient temperature	-5 - +60°C	-20 - +60°C
Min detector current required (with flame)	45 µA dc	45 µA dc
Max perm. detector current (without flame)	5.5 µA dc	5.5 µA dc

160303-333

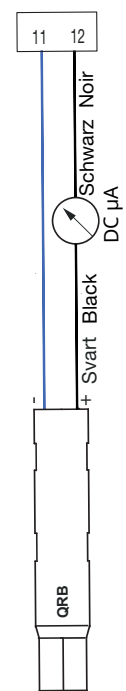

5.4 Colour codes LMO14/24

When the burner starts, the light in the reset switch indicates the normal sequence, and also indicates whether something abnormal is happening as per the following table:

Preheater in operation	Solid yellow
Ignition switched on	Flashing yellow
Normal operation	Solid green
Operation, poor flame signal	Flashing green
Undervoltage	Flashing yellow-red
Fault, alarm	Solid red
False light	Flashing red-green
Communication mode	Fluttering red

5.5 Fault codes LMO14/24

When the red light for a blocked relay box comes on, you can get information about what has caused the problem by pressing and holding the reset button for 3 seconds.

The number of flashes below is repeated with a pause in between.

2 flashes	No flame signal when safety time expires
4 flashes	False light during start
7 flashes	3 x Losses of flame during operation
8 flashes	Time-out for preheater *
10 flashes	Incorrect wiring, internal fault or simultaneous occurrence of two faults

* In order for this fault code to occur, the preheater shall not reach its cut-off temperature within 10 mins. from switch on.

To return to normal operation: Press the reset button for 1 second.

If the reset button is instead kept pressed a second time for at least 3 seconds, you can, via an interface, obtain the corresponding information on a computer or flue gas analyser.

To return to normal operation: Press the reset button for 1 second.

6. Pump

6.1 SUNTEC AS

Technical data AS47CK		
One or two-pipe system		
Viscosity range:	1-12 mm ² /s	
Pressure range:	7-14 bar	
Rated voltage of coil:	220/240V	50/60 Hz
Oil temperature:	max 60°C	

Technical data AS67C		
One or two-pipe system		
Viscosity range:	1-12 mm ² /s	
Pressure range:	10-15 bar	
Rated voltage of coil:	220/240V	50/60 Hz
Oil temperature:	max 60°C	

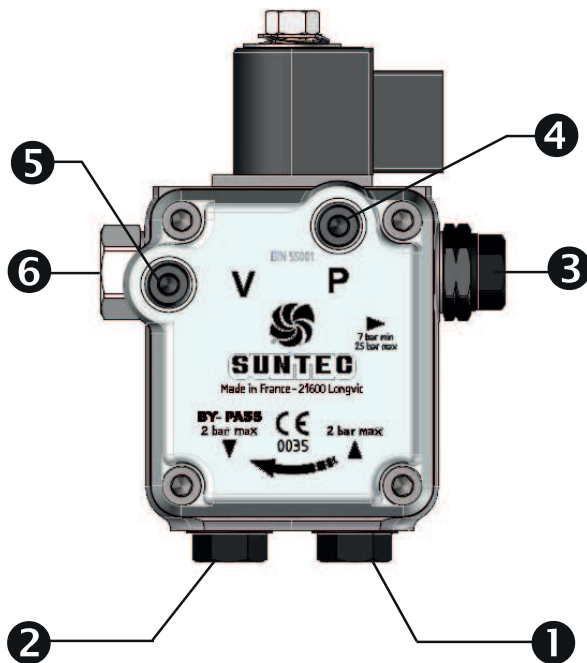

Components

1. Suction line G 1/4"
2. Return line G 1/4" and internal by-pass plug
3. Nozzle outlet G 1/8"
4. Pressure gauge port G 1/8"
5. Vacuum gauge port G 1/8"
6. Pressure adjustment

Applications for SUNTEC AS

The SUNTEC AS oil pump has a built in solenoid valve which controls the regulator cut-off valve giving fast cut-off and cut-on function independent of the rotational speed.

Applications

Light oil, B10 heating oil/biofuel blend (as defined in DIN V51603-6) and kerosene.

- One or two-pipe system.

Pump operating principle

The gear set draws oil from the tank through the built-in filter and transfers it to the valve that regulates the oil pressure to the nozzle line. All oil that does not go through the nozzle line will be dumped through the valve back to the return line in two pipe installation or, if it is a one-pipe installation, back to suction port in the gear set.

In that case, the by-pass plug must be removed from the return port, and the return port sealed by steel plug and washer.

The solenoid valve of the AS pump is of the "normally opened" type.

When the solenoid valve is non-activated, the by-pass channel between the pressure and return sides of the valve is open. No pressure will then be built up to open the valve; it does not matter which speed the gear set has.

When the solenoid is activated, this by-pass channel is closed and because of the full speed of the gear set, the pressure necessary to open the valve will be built up very rapidly, which gives a very sharp cut-on function.

Cut-off

When the burner stops, the solenoid opens the by-pass at the same moment, which drains all the oil down to the return, and the nozzle valve closes immediately.

This gives a very sharp cut-off function. The cut-on and cut-off can be actuated regardless of motor speed and have an extremely fast response.

When the solenoid is not activated, the torque requirement is low up to full motor speed.

Bleeding

Bleeding of pumps with two-pipe systems takes place automatically, but bleeding can be accelerated by opening a pressure port.

On pumps with a single-pipe system, a pressure port must be opened to empty the system of air.

One pipe installation

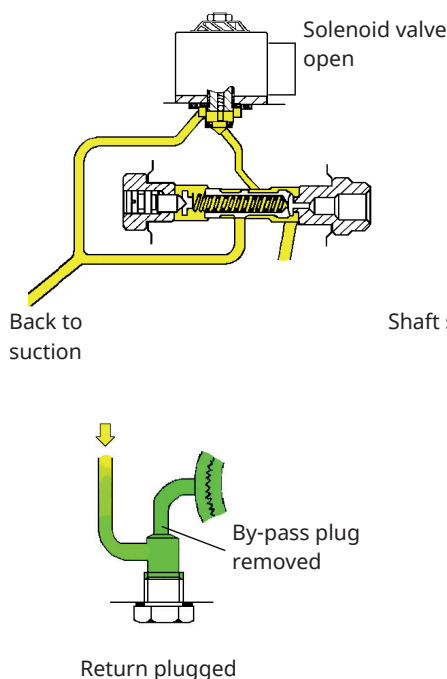

Two pipe installation

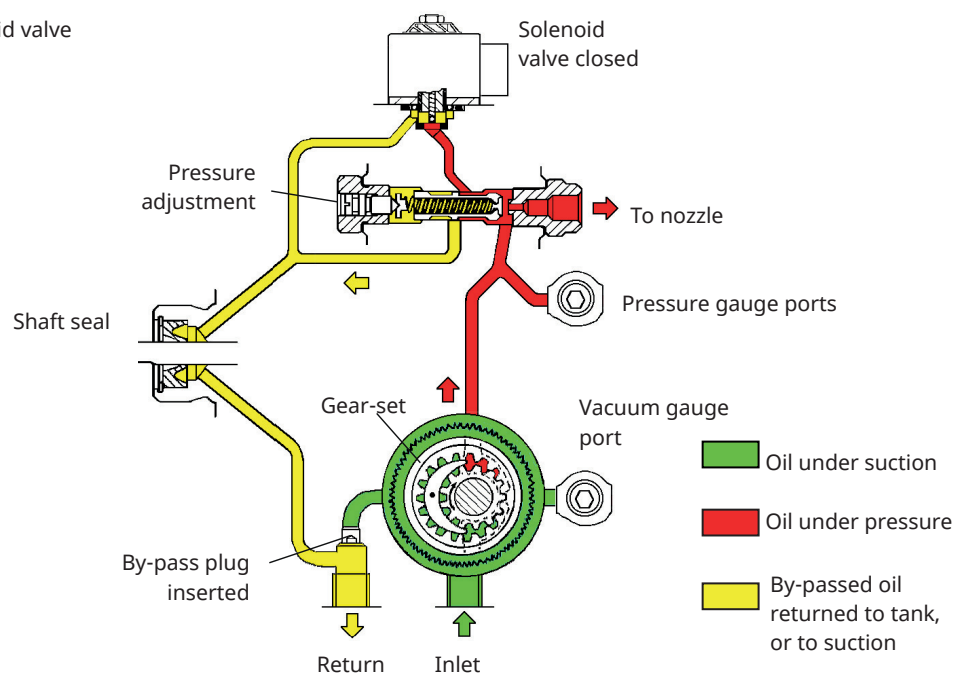

6.1.1 Suction line tables

6.1.1.1 Overlying tank

1-pipe system

Nozzle*/Düse* Gicleur*/Ugello* (US GPH)		0,50	0,60	0,80	1,00	1,50	2,00	4,00	6,00	9,50									
H (m)	d (mm)	4	4	4	4	6	4	6	8	4	6	8	4	6	8	10			
0		90	75	56	45	30	150	22	113	11	56	150	7	37	119	4	23	74	150
0,5		100	83	63	50	33	150	25	126	12	63	150	8	41	133	4	26	83	150
1		110	92	69	55	37	150	27	139	13	69	150	8	46	146	5	28	92	150
2		131	109	82	65	44	150	33	166	16	82	150	10	55	150	6	34	109	150
3		152	126	95	76	50	150	38	192	18	96	150	12	63	150	7	39	127	150
4		172	144	108	86	57	150	43	218	21	109	150	14	72	150	8	45	144	150

*A2L pumps : sum up the 2 nozzles / A2L-Pumpen : Summe der zwei Düsen
pompe A2L : somme des 2 gicleurs / Perle pompe A2L aggiungere n.2 ugelli

One pipe siphon feed system
Einstranginstallation - Tank höher als Pumpe
Installation monotube en charge
Impianti monotubo a sifone

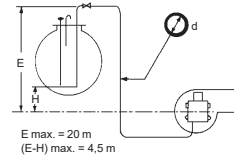

Two-pipe system

Pump/Pumpe Pompe/Pompa		35/45				55				65				75				95			
Q** (l/h)		60				77				102				130				150			
H (m)	d (mm)	4	6	8	10	6	8	10	12	6	8	10	12	14	8	10	12	14			
0	2	15	50	124	11	38	96	150	7	27	71	150	20	54	116	150	16	46	100	150	
0,5	2	16	56	138	12	42	107	150	8	31	79	150	23	61	130	150	19	52	112	150	
1	2	18	61	150	13	47	118	150	9	34	88	150	26	68	144	150	21	57	124	150	
2	3	22	73	150	16	56	141	150	11	41	105	150	31	81	150	150	26	69	148	150	
3	4	26	85	150	19	66	150	150	13	48	122	150	36	94	150	150	31	81	150	150	
4	4	30	97	150	22	75	150	150	16	55	139	150	42	108	150	150	35	92	150	150	

**Q = pump capacity @ 0 bar / Pumpenleistung bei 0 bar
capacité de l'engrenage à 0 bar / portata della pompa a 0 bar.

Two pipe siphon feed system
Zweistranginstallation - Tank höher als Pumpe
Installation bitube en charge
Impianti bitubo a sifone

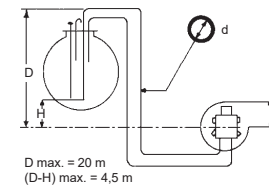

6.1.1.2 Underlying tank

1-pipe system

With an underlying tank a 1-pipe-system is not recommended

Two-pipe system

Pump/Pumpe Pompe/Pompa Q** (l/h)	35/45 60				55 77				65 102				75 130				95 150			
	d (mm)		H (m)		d (mm)		H (m)		d (mm)		H (m)		d (mm)		H (m)		d (mm)		H (m)	
0	15	50	124	150	11	38	96	150	7	27	71	150	20	54	116	150	16	46	100	150
0.5	13	44	109	150	9	33	84	150	6	24	62	132	17	48	103	150	14	40	88	150
1	11	38	95	150	8	29	73	150	4	20	54	115	15	41	89	150	12	34	76	144
2	7	26	66	138	5	19	51	107	2	13	37	80	9	28	61	116	7	23	52	100
3	3	14	37	79		10	28	60		6	20	44	4	14	33	65		11	28	55
4			8	19			5	14				9			6	14			4	11

Two pipe lift system
Zweistranginstallation - Tank tiefer als Pumpe
Installation bitube en aspiration
Impianti bitubo in aspirazione

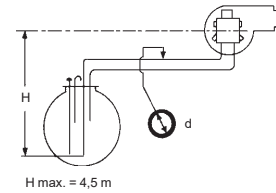

The suction line tables consist of theoretically calculated values where the pipe dimensions and oil velocity have been matched so that tur-bulences will not occur. Such tur-bulences will result in increased pressure losses and in acoustic noise in the pipe system. In addition to drawn copper piping a pipe system usually comprises 4 elbows, a non-return valve, a cut-off valve and an external oil filter.

The sum of these individual resi-stances is so insignificant that they can be disregarded. The tables do not include any lengths exceeding 100 m as experience shows that longer lengths are not needed.

The tables apply to a standard fuel oil of normal commercial quality according to current standards. On commis- sioning with an empty tube system the oil pump should not be run without oil for more than 5 min. (a condition is that the pump is being lubricated during operation).

The tables state the total suction line length in metres at a nozzle capacity of 9,5 Gph. Max. permissible pressure at the suction and pressure side is 2,0 bar.

6.1.2 Check oil line seals

When the burner has been installed and put into operation, the tightness of the various coupling elements should be checked (A), in case of leakage - retighten the coupling elements.



Use caution when operating the burner, surfaces may be hot.



When servicing oil bearing components, check for oil leakage when the burner are put into operation.

6.1.3 Replacement of pump filter

1. Close the oil supply to the burner.
2. Loosen the pump cover's screws.
3. Remove the filter and gasket.
4. Mount new gasket and filter.
5. Refit the cover.
6. Open the oil supply.
7. Start the burner, check seals and combustion.

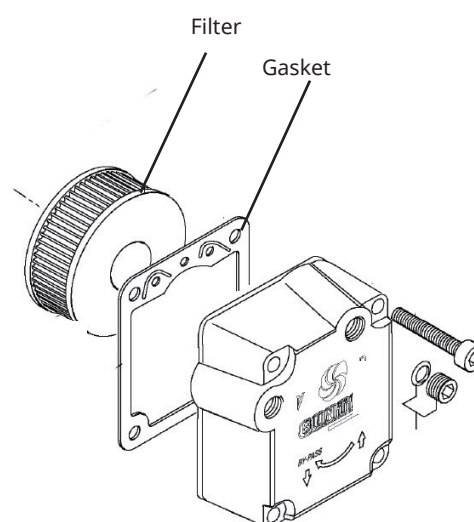

When servicing/replacing components that affect combustion, flue gas analysis and soot test must be carried out following installation.

6.1.4 Replacing the solenoid valve (pump)

1. Disconnect the main power and shut off the fuel supply.

! Before obtaining access to terminals, all supply circuits must be disconnected.

1. Disconnect power cables to solenoid valves.
2. Loosen nut holding the solenoid coil.
3. Loosen screws that secures the valve mounting plate.
4. Remove valve.
5. Check that it is the correct valve. NO
6. Install the new valve and refit the other parts in the reverse order.
7. Check functionality.

6.1.5 Replacing the gasket seal (pump)

1. Disconnect hoses, oil lines, and electrical cables.
2. Loosen pump (screw J).
3. Loosen locking rings for gasket seal.
4. Remove the old gasket seal (2).
5. Install the new gasket seal.
6. Connect hoses, oil lines, and electrical cables.
7. Test run and check seals.

Components Oil pump

1. Pressure regulator
2. Shaft seal kit (lip seal + protective cone)
3. By-pass plug
4. G 1/4 gasket
5. G 1/4 steel plug (1-pipe system)
6. Filter
7. Cover gasket
8. Cover
9. Pressure gauge port or vacuum gauge port screw, O-ring
10. Coil
11. Tube assy

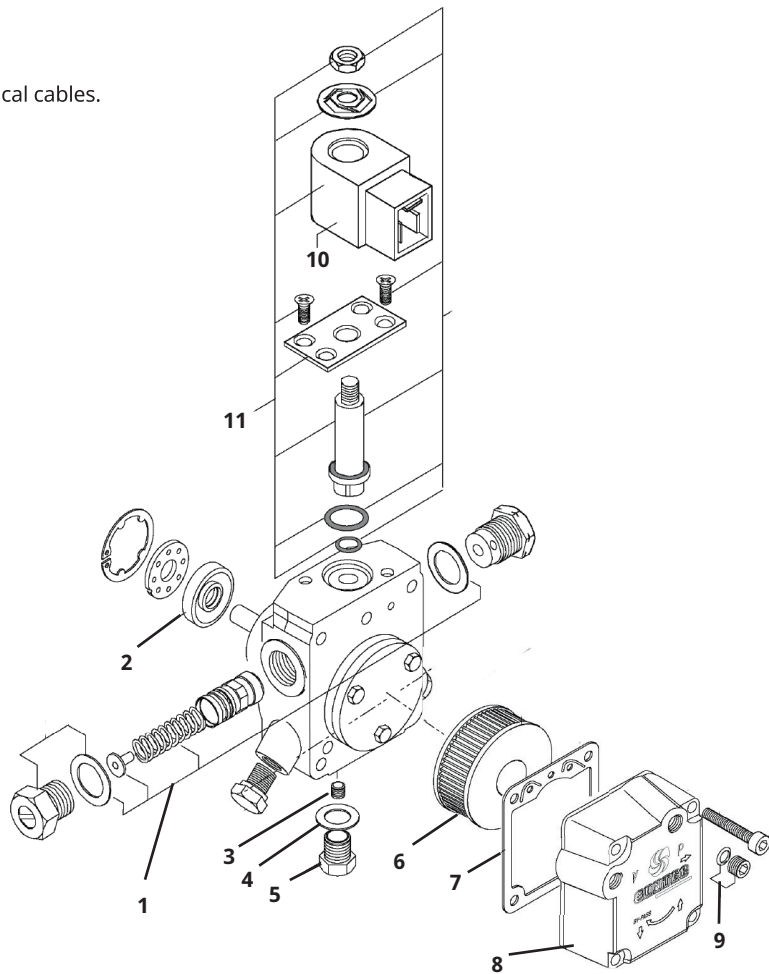

7. Service

Service and maintenance work may only be performed by qualified personnel. Perform operational check of all safety systems and components at each service. Only Enertech original parts should be used when replacing components.



Use caution when operating the burner, surfaces may be hot.



7.1 Burner Service Schedule, Oil

Servicing must be carried out once a year or after 3,000 hours of operation.

Burner	1 year	3,000 h
Filter	1 year replacement	3,000 h replacement
Oil hose	1 year inspection/replacement	
Nozzle	1 year replacement	3,000 h replacement
Electrodes	Replacement/cleaning 1 year	Replacement/cleaning 3,000 h
Brake disc	Replacement/cleaning 1 year	Replacement/cleaning 3,000 h
Motor	1 year	3,000 h
Drive shaft	Check/replace in the event of damage	Check/replace in the event of damage
Fan wheel	"1 year Replace if need for cleaning/imbalance"	"3000 h Replace if need for cleaning/imbalance"
Oil filter	Once a year	3,000 h replacement
Oil valve	Tightness check once a year	Replace if leakage detected

7.2 Component replacement intervals

Components	Service life - Recommended replacement	Service life - Recommended replacement Operating cycles
Control system	10 years	250,000 cycles
Pressure switch	10 years	250,000 cycles
Ignition system with flame guard	10 years	250,000 cycles
UV flame sensor	10,000 h	N/A
Damper motor		500,000 cycles
Contactora	10 years	500,000 cycles



The burner and its components must be recycled according to applicable regulations.

7.3 Combustion device

1. Disconnect the main power and shut off the fuel supply.
2. Remove the burner from the boiler by loosening the screw (A).
3. Loosen the housing screw (B) and remove the front cover (C).
4. Visually inspect the combustion assembly and check the various components for defects.
5. Loosen and pull off the brake plate/package from the oil pipe. Clean the brake plate as necessary.
6. Unscrew the nozzle.
7. Fit the nozzle. Do not clean the nozzle. If the nozzle is defective, it must be cleaned.
8. Check the ignition electrodes. Replace as necessary (refer to Technical data for electrode settings).
9. Install the brake plate and electrode package (see Fig. 1.2). Check that the distance between the nozzle and brake plate is correct (refer to Technical data).
10. Fit the front cover and insert the burner into the boiler.
11. Switch on the main power and open the fuel supply.
12. Start burner and check/adjust combustion.

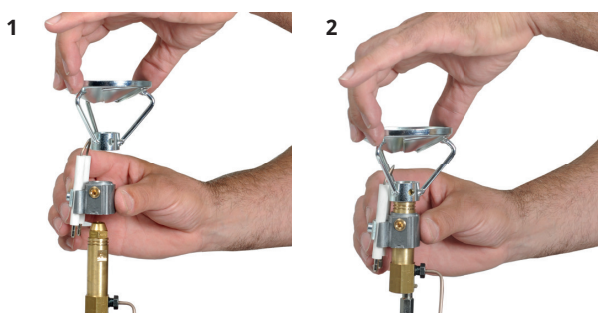
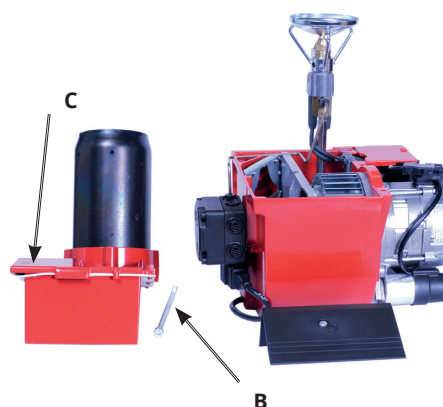
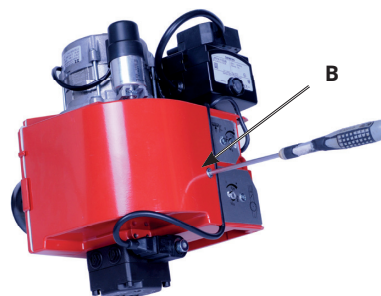

When servicing/replacing components that affect combustion, an analysis and soot test must be carried out on the installation.

7.4 Replacing the preheater

1. Disconnect the main power and shut off the fuel supply.
2. Remove the burner from the boiler by loosening the screw (A).
3. Loosen the housing screw (B) and remove the front cover (C).
4. Remove the preheating and ignition cables.
5. Loosen and pull the brake disc off the preheater. Clean the brake plate as necessary.
6. Unscrew the nozzle.
7. Loosen the nut holding the oil pipe and preheater together.
8. Install the new preheater. Check the condition of the O-ring, replace if necessary.
9. Fit the nozzle. Do not clean the nozzle. If the nozzle is defective, it must be cleaned.
10. Fit the brake plate/electrode package. Check that the distance between the nozzle and brake plate is correct, (see Technical data).
11. Connect the preheating and ignition cables.
12. Fit the front cover and insert the burner into the boiler.
13. Switch on the main power and open the fuel supply.
14. Start burner and check/adjust combustion.



! When servicing/replacing components that affect combustion, an analysis and soot test must be carried out on the installation.

7.5 Replacing the oil pump

1. Disconnect the main power and shut off the fuel supply.
2. Undo the oil hoses from the pump.
3. Remove the burner from the boiler by loosening the screw (A).
4. Loosen the housing screw (B) and remove the front cover (C). This will make it easier to install the pump.
5. Disconnect the solenoid valve cable from the pump.
6. Disconnect the connection tube (D) from the pump.
7. Loosen the screws (E) and pull out the oil pump.
8. Install the new oil pump on the burner. Tighten the screws and fit the connection tube (D). (It is important that the pump shaft splines align correctly in the pump coupling).
9. Fit the front cover and insert the burner into the boiler.
10. Fit the oil hoses (for conversion between single-pipe and double-pipe systems, see Pump instructions).
11. Switch on the main power and open the fuel supply.
12. Start burner, purge pump, adjust to correct pressure and check/adjust combustion.

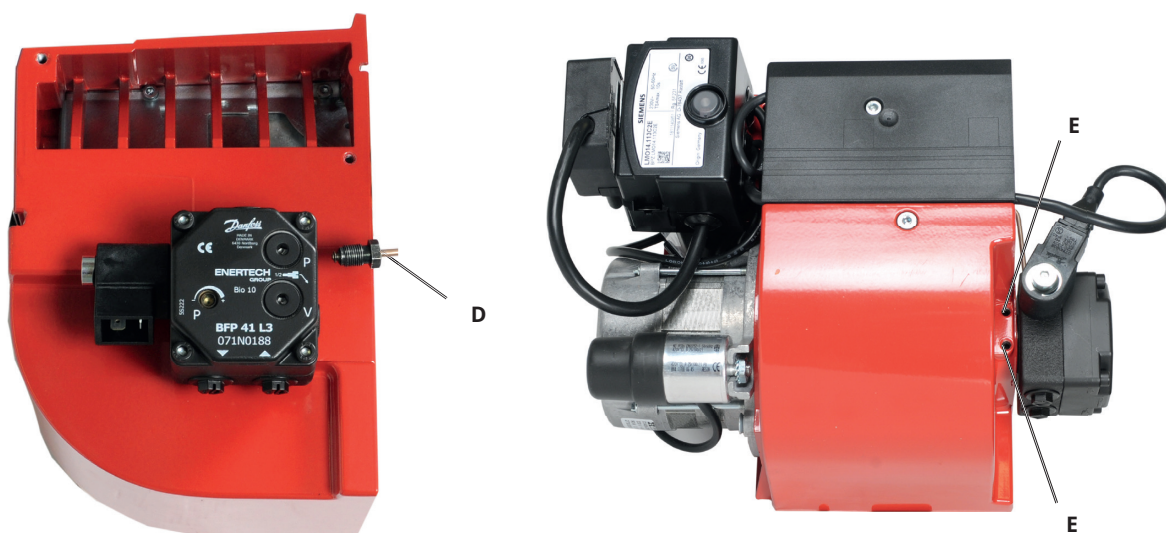

When servicing/replacing components that affect combustion, an analysis and soot test must be carried out on the installation.

7.6 Replacing the fan motor and fan wheel

1. Disconnect the main power and shut off the fuel supply.
2. Remove the burner from the boiler by loosening the screw (A).
3. Loosen the housing screw (B) and remove the front cover (C). This will make it easier to fit the motor and fan wheel.
4. Disconnect the electrical connector to the motor.
5. Loosen the spring (G) holding the transformer.
6. Loosen the screws (F) (x2) holding the motor flange.
7. Lift out the motor.
8. Remove the end of the drive coupling from the motor axle, loosen and remove the fan wheel.
9. Fit the fan wheel to the motor, tighten the locking screw. The fan wheel must be fitted with a little play between the motor and the fan wheel. Make sure that there are no scratching noises. Refit the end of the drive coupling.
10. Align the motor flange with the fan housing. Make sure the drive coupling has not fallen out and that it is correctly inserted in the end of the drive coupling on the motor and pump. Also ensure that no cables are pinched.
11. Re-assemble the motor and fan housing. Alternately tighten the screws. This is done to ensure the fan housing and the motor flange are aligned in the correct position.
12. Connect the motor cable.
13. Refit the spring (G) holding the transformer.
14. Assemble the fan housing and front cover and insert the burner into the boiler.
15. Switch on the main power and open the fuel supply.
16. Start burner and check/adjust combustion.

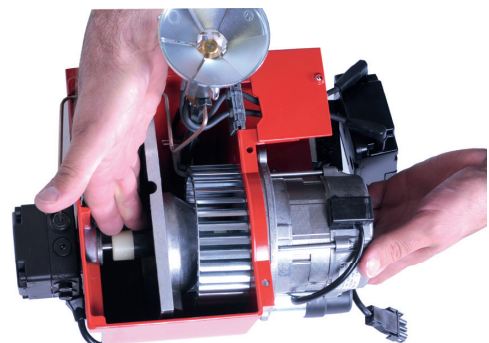
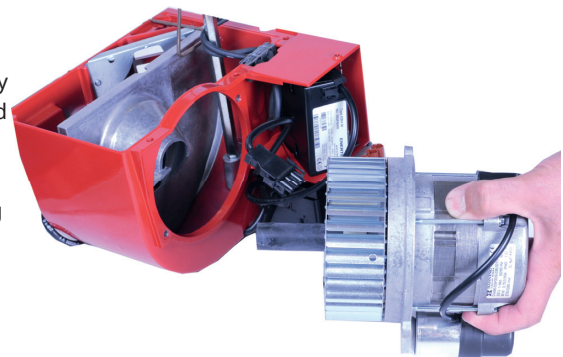
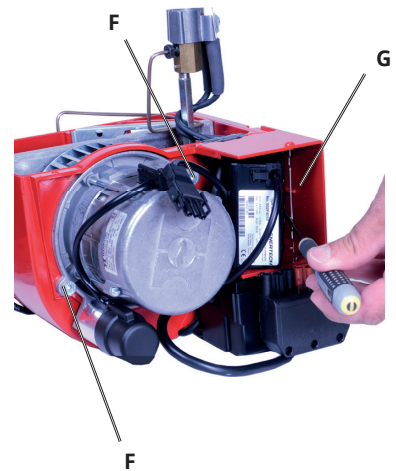

! When servicing/replacing components that affect combustion, an analysis and soot test must be carried out on the installation.

7.7 Air intake and intake cone

1. Disconnect the main power and shut off the fuel supply.
2. Remove the burner from the boiler by loosening the screw (A).
3. Loosen the housing screw (B) and remove the front cover (C).
4. Loosen the motor and oil pipes.
5. Remove the air intake.
6. Check the functionality and appearance of the various components in the air regulator. Clean and replace components as necessary.
7. Assemble the burner. Make sure to refit in the same position as before disassembly.
8. Switch on the main power and open the fuel supply.
9. Start burner and check/adjust combustion.

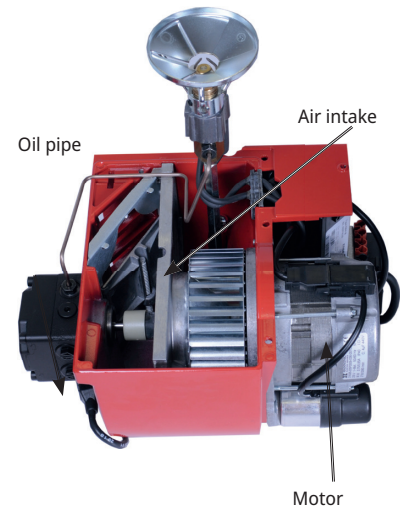

7.8 Replacing the entire electrical package

1. Disconnect the main power and shut off the fuel supply.
2. Remove the burner from the boiler by loosening the screw (A).
3. Remove the cover.
4. Disconnect the electrical connector to the motor.
5. Disconnect the electrical connector to the transformer.
6. Disconnect the electrical connector to the pump.
7. Remove the photoresistor.
8. Remove the burner control and loosen the two bottom screws in the relay socket.
9. The Europlug plate is firmly attached under the relay socket.
10. Fit the new electrical package (do not forget the Europlug).
11. Refit the photoresistor.
12. Connect the motor cable, transformer cable and pump cable.
13. Turn on the burner control.
14. Refit the cover.
15. Switch on the main power and open the fuel supply.
16. Start burner and check/adjust combustion.



! When servicing/replacing components that affect combustion, an analysis and soot test must be carried out on the installation.

7.9 Replacing individual electrical package components

1. Disconnect the main power and shut off the fuel supply.
2. Remove the burner from the boiler by loosening the screw (A).
3. Remove the burner control and loosen the two bottom screws in the relay socket.
4. The Europlug plate is firmly attached under the relay socket.
5. Remove the cable of the component to be replaced.
6. Connect the new cable.
7. Refit the electrical package (do not forget the Europlug).
8. Turn on the burner control.
9. Switch on the main power and open the fuel supply.
10. Start burner and check/adjust combustion.

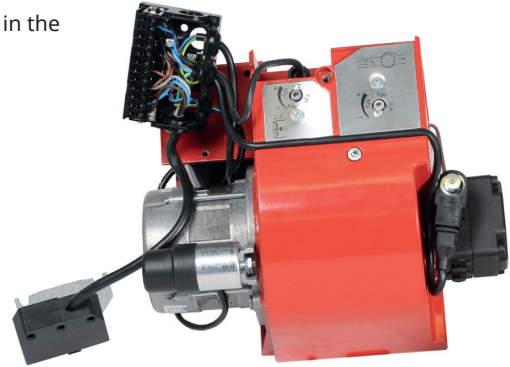

! When servicing/replacing components that affect combustion, an analysis and soot test must be carried out on the installation.

8. Fault Location

8.1 Burner will not start

Symptom	Causes	Remedies
Motor starts	Unstable flame	Adjust the damper
Burner pre-ventilates	Excess air	
	Low oil pressure	
Flame formed		Check the oil pressure
Burner trips	Incorrect combustion apparatus settings	
		Check the nozzle in relation to the combustion apparatus dimensions and the ignition electrode position
Motor starts	Flame monitor does not register light	
Burner pre-ventilates	Defective flame monitor	
No flame formed	Defective oil burner control	Check the flame monitor is clean and can register light
Burner trips		
		Check with using new photocell
		Check using new oil burner control (Note: replacement of photocell recommended if oil burner control replaced)
	No oil	Check the oil supply to the burner and that there are no air bubbles in the pump
	False light	
		Check function of solenoid
	No spark	Check flame monitor does not register ambient light
		Check high voltage wiring and ignition electrodes
Motor does not start	Preheater does not get up to temperature.	Check preheater function

8.2 Burner will not start after normal use

Symptom	Causes	Remedies
Burner does not start	Fuse blown	Check and replace fuse as necessary. Investigate cause of fault
	Boiler thermostat has not reset	
	Preheater does not get up to temperature	
		Adjust thermostat
Burner pre-ventilates	Overheating protection has deployed	Check preheater function
	Defective preheater	
	Defective oil burner control or flame monitor	Reset the overheating protection. Investigate the cause of its deploying. Remedy fault
		Check by replacing with new
Burner stops	No oil supply	Check that tank, oil lines, solenoid valves, pump and nozzle are in good condition
	Too great a pressure drop at brake plate	
	Too strong draught prevents flame forming	Adjust the burner
		Correct the boiler draught
	No spark	Check the ignition transformer. Check the ignition electrode settings and ceramics
	Preheater temperature too low	Check preheater function
	New oil type	Adjust the preheater's set operating temperature
		Check that the oil used has the physical parameters that the burner is rated for. If not, change the oil.

8.3 Delayed ignition

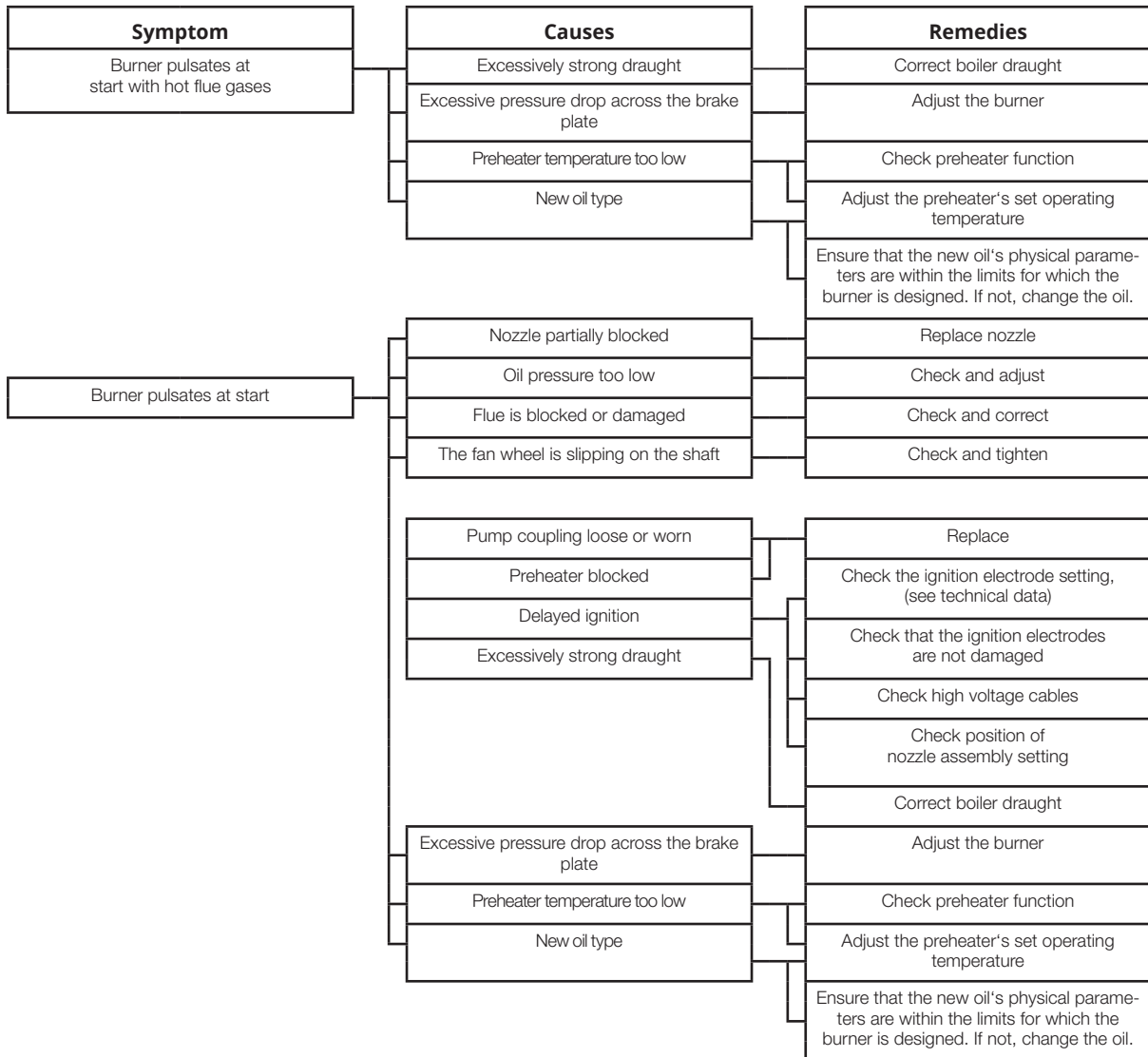

8.4 Noise in pump

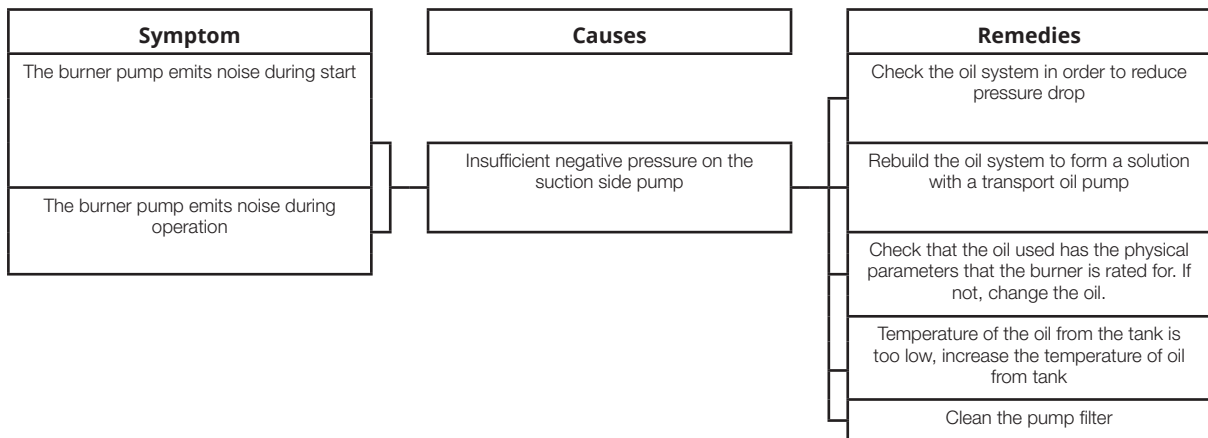

8.5 Pump pressure

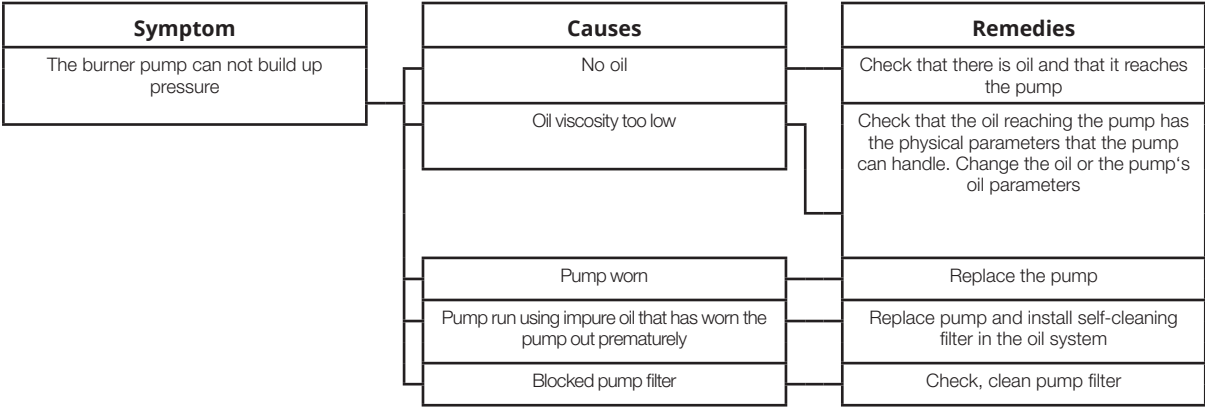

9. Log of flue gas analysis

Owner	Adresss	Tel. no:
Installation		Tel. no:

Boiler

Type	Make	Power kW
------	------	----------

Burner

Type	Model	Serial no.	Fuel
------	-------	------------	------

	Step 1	Step 2	Step 3
Draught in fireplace			
Fan Press mbar			
Filter smoke number			
CO ₂			
O ₂			
NOx			
CO			
Flue gas temp. °C			
Setting brake disc			
Setting Air damper			
Pump pressure bar			
Nozzle			

Test performed / 20	Address
Test performed by:	Postal address
Company name:	Tel. no:



EU Declaration of conformity

Bentone Oil Burners

Type:

BF 1	ST 133	B 40	B 65
ST 108	ST 146	B 45	B 70
ST 120	B 30	B 55	B 80

This declaration of conformity is issued under the sole responsibility of the manufacturer.
The object of the declaration described above is in conformity with:

- **Machinery Directive 2006/42/EC**
- **EMC 2014/30/EU**
- **The Restriction of the Use of Certain Hazardous Substances (RoHS) Directive 2011/65/EU**

References to the relevant harmonised standards used or references to the other technical specifications in relation to which conformity is declared:

EN 267:2020 Excluding the requirements of Annex J/K.
Automatic forced draught burners for liquid fuels.

Additional information can be downloaded at: www.bentone.com

Manufacturer: Enertech AB
Näsvägen 8
SE-341 34 LJUNGBY
Sweden

Notified Body: TUV SÜD Product Service GmbH
Ridlerstraße 65
D-80339 München, Germany
Notified Body Number: 0123

Ljungby, 2022-10-10

Joachim Hultqvist
Technical Manager
Enertech AB

Ola Karlsson
Quality Manager
Enertech AB

UK Declaration of conformity

Bentone Oil Burners

Type:

BF 1	ST 133	B 40	B 65
ST 108	ST 146	B 45	B 70
ST 120	B 30	B 55	B 80

This declaration of conformity is issued under the sole responsibility of the manufacturer.
The object of the declaration described above is in conformity with:

- **Supply of Machinery (Safety) Regulations 2008**
- **Electromagnetic Compatibility Regulations 2016**
- **The Restriction of the Use of Certain Hazardous Substances in Electrical and Electronic Equipment Regulations 2012**

References to the relevant harmonised standards used or references to the other technical specifications in relation to which conformity is declared:

BS EN 267:2020 Excluding the requirements of Annex J/K.
Automatic forced draught burners for liquid fuels.

Additional information can be downloaded at: www.bentone.com

Manufacturer: Enertech AB
Näsvägen 8
SE-341 34 LJUNGBY
Sweden

Approved Body: TUV SÜD BABT Unlimited
Octagon House,
Concorde Way, Segensworth North,
Fareham, Hampshire,
PO 15 5RL, United Kingdom
Approved Body Number: 0168

Ljungby, 2022-10-10

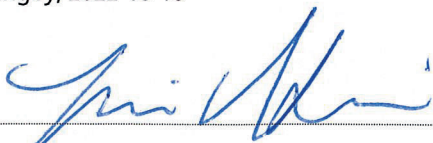

Joachim Hultqvist

Technical Manager
Enertech AB



Ola Karlsson

Quality Manager
Enertech AB

