



Bentone B 45

Reservdelar och tillbehör

Spare Parts and Accessories

Ersatzteile und Zubehör

Pièces détachées et accessoires



MADE IN SWEDEN

Innehåll - Index - Inhalt - Sommaire

1. Brännarrör - Flame tube - Brennerrohr - Tube de brûleur	4
2. Insats - Nozzle assembly - Düsenstock - Ligne porte-gicleur	5
3. Anslutningsfläns - Fixing flange - Anschlussflansch	
- Bride de fixation	6
4. Motor - Motor - Motor - Moteur	7
5. Pump - Pump - Pumpe - Pompe	9
6. Elkomponenter - Electrical - Elektrische - Électriques	12
7. Fläkthus - Fan housing - Lüftergehäuse	
- Carter de ventilateur	16
8. Luftreglering - Air control - Luftsteuerung	
- Régularisation à air	17
9. Övrigt - Sundries - Verschiedenes - Divers	18

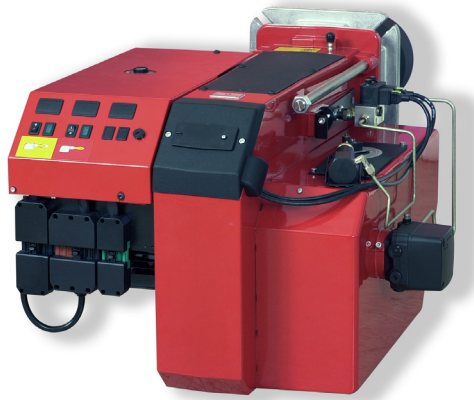

1. Brännarrör - Flame tube - Brennerrohr - Tube de brûleur

Namn	Name	Name	Nom	Information	Artikel nr
1 Brännarrör	Flame tube	Brennerrohr	Tube de brûleur	B45 L=270 mm	0011934901
1 Brännarrör	Flame tube	Brennerrohr	Tube de brûleur	B45 L=370 mm	0011934902

1				
---	---	--	--	--

2. Insats - Nozzle assembly - Düsenstock - Ligne porte-gicleur

Namn	Name	Name	Nom	Information	Artikel nr
2 Insats kompl.	Nozzle assembly compl.	Düsenstock kompl.	Ligne porte-gicleur compl.	B45 A2.2	0011954601
2 Insats kompl.	Nozzle assembly compl.	Düsenstock kompl.	Ligne porte-gicleur compl.	B45 A2.2, L	0011954602
7 Oljerör kompl.	Nozzle line compl.	Düsenrohr kompl.	Canne porte-gicleur compl.	B45-2	0011847801
7 Oljerör kompl.	Nozzle line compl.	Düsenrohr kompl.	Canne porte-gicleur compl.	B45-2L	0011847802
11 Bromsskiva	Brake plate	Stauscheibe	Disque accroche-flamme	B45 2.2, Ø 120 mm	0011934701
14 Bygel	Clamp	Bügel	Crampon		0011273801
15 Bygel	Clamp	Bügel	Crampon		0011155201
18 Tändelektrod, par	Ignition electrode, Pair of	Zündelektrode, Paar	Electrode d'allumage, 1 paire	B45-2	0091924501
20 Ställplatta kompl.	Adjustment plate compl.	Stellplatte kompl.	Platine de réglage compl.	B 45-2H	0011822901
21 Ställplatta kompl.	Adjustment plate compl.	Stellplatte kompl.	Platine de réglage compl.	B45 A2.2R	0011946802
23 Axel kompl.	Shaft compl.	Achse kompl.	Arbre compl.	B45 A2.2R	0091829802
24 Reglerdon	Adjustment device	Regelgerät	Dispositif de réglage	B45 A2.2R	0091948701
25 Packningssats, reglerdon	Gasket kit, adjustment device	Dichtung set, Regelgerät	Kit joint, dispositif de réglage	B45 A2.2R	0011832202

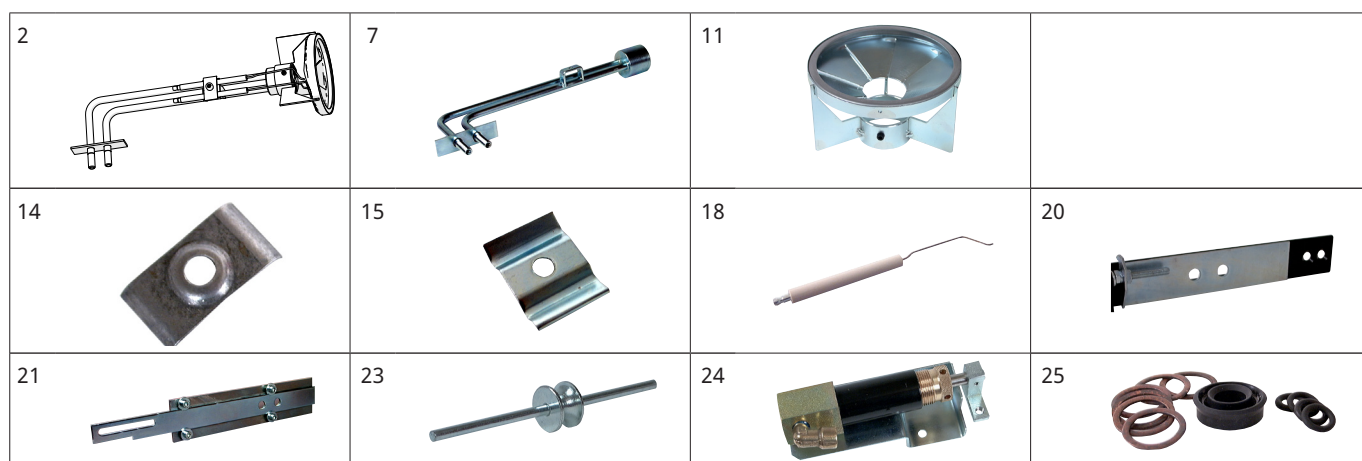

3. Anslutningsfläns - Fixing flange - Anschlussflansch - Bride de fixation

Namn	Name	Name	Nom	Information	Artikel nr
1 Anslutningsfläns kompl.	Fixing flange compl.	Anschlussflansch kompl.	Bride de fixation compl.		0011823002
2 Anslutningsfläns	Fixing flange	Anschlussflansch	Bride de fixation		0011797501
3 Gejder	Guide	Führungsschienen	Guides		0011809301
4 Packning, fläktusfläns	Gasket	Dichtung	Joint	Ø 126/180*2	0012134101
5 Packning	Gasket	Dichtung	Joint	B45 A2.2, B45 A2.2H, B45 A2.2R	0011278802

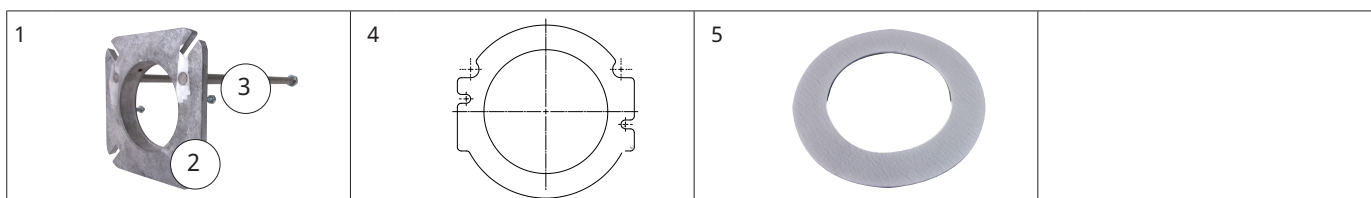

4. Motor - Motor - Motor - Moteur

Namn	Name	Name	Nom	Information	Artikel nr
1 Motor Simel ers. av FHP med plugg & kabel 1-fas	Motor Simel replaced by FHP with plug & cable 1-phase	Motor Simel ersetzt durch FHP mit Stopfe & Kabel 1-phasig	Moteur Simel remplacée par FHP avec tampon & câble monophasé	450 W, 1F, 16 μ , IE2	0092091003
1 Motor Simel ers. av FHP med plugg & kabel 3-fas	Motor Simel replaced by FHP with plug & cable 3-phase	Motor Simel ersetzt durch FHP mit Stopfe & Kabel 3-phasig	Moteur Simel remplacée par FHP avec tampon & câble triphasé	650 W 3F 50/60 Hz	0092091702
2 Motor	Motor	Motor	Moteur	650 W 50/60 Hz, 25 μ F	0092091603
3 Motor	Motor	Motor	Moteur	FHP 620 W 3F 460V 60Hz	0091993302

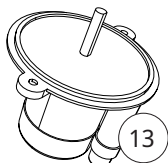

92091002

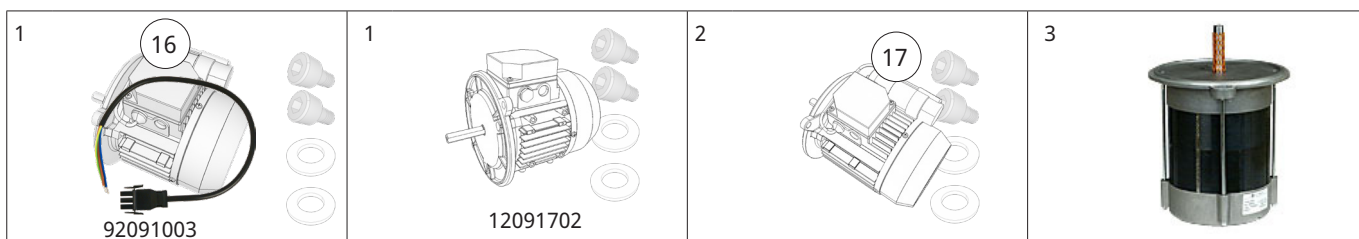

4. Motor - Motor - Motor - Moteur

Namn	Name	Name	Nom	Information	Artikel nr
4 Kondensator	Capacitor	Kondensator	Condensateur	16µF (620W)	0012093401
5 Fläkthjul	Fan wheel	Gebbläserad	Rotor	180X74X12.7	0011277623
7 Avskärmningskon	Conical shield plate	Abschirmkonus	Cone deflecteur d'air		0011895401
9 Kopplingsdel, pump	Coupling part, pump	Kupplingsstück, Pumpe	Manchon d'accouplement, pompe	Danfoss	0439044866
9 Kopplingsdel, pump	Coupling part, pump	Kupplingsstück, Pumpe	Manchon d'accouplement, pompe	Suntec	0439044868
11 Kopplingsände, fläkthjul	Coupling part, fan wheel	Kupplungsstück, Gebläserad	Manchon d'accouplement, rotor		0011127901
12 Drivkoppling	Coupling	Kupplung	Accouplement	RSA, Danfoss	0011127830
12 Drivkoppling	Coupling	Kupplung	Accouplement	Suntec	0011127831
13 Kondensator	Capacitor	Kondensator	Condensateur	Simel 450 W, 10 µF	0012093901
15 Motorfläns	Flange, motor	Flansch, motor	Bride, moteur		0011928500
16 Kondensator	Capacitor	Kondensator	Condensateur	16µF 450V, to motor 12091003 450W	0012142701
17 Kondensator	Capacitor	Kondensator	Condensateur	25µF 450V, to motor 12091603 650W	0012142901

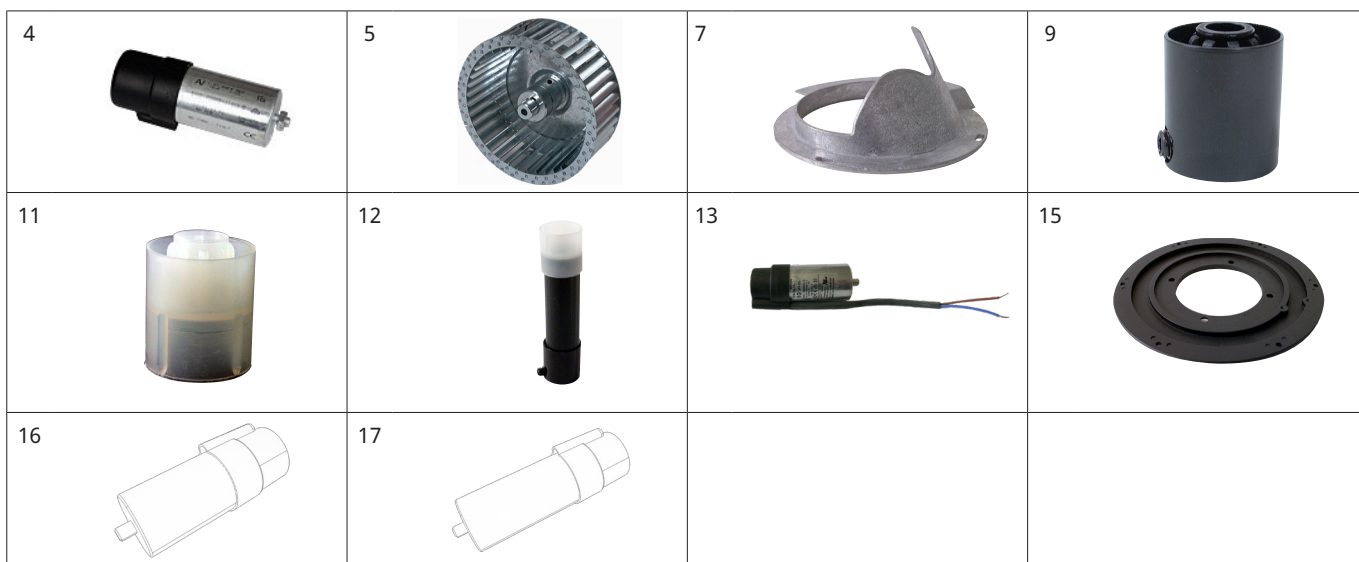

5. Pump - Pump - Pumpe - Pompe

Namn	Name	Name	Nom	Information	Artikel nr
1 Pump	Pump	Pumpe	Pompe	RSA 60, B 45 A2.2R	0011019718
2 Filtersats	Filter set	Filtersatz	Jeu de filtre	RSA 60, 90, 125	0011783201
3 Pump, med kabel x2	Pump, with cable x2	Pumpe, mit Kabel x2	Pompe, avec câble x2	A2L, B 45 A2.2H, B 45 A2.2	0092026426
4 Pump	Pump	Pumpe	Pompe	A2L, B 45 A2.2H, B 45 A2.2	0012026426
5 Magnetventil	Solenoid valve	Magnetventil	Électrovanne	A2L, B 45 A2.2H, B 45 A2.2	0011597204
6 Filtersats, filter, packningar, o-ring	Filter kit, filter, gaskets, o-ring	Filter Kit, Filter, Dichtungs, O-Ring	Kit de filtre, filtre, joint, joint torique	Suntec, AN,AS,AP,AT,AL-67	0011457002
7 Filtersats, filter, packningar, o-ring	Filter kit, filter, gaskets, o-ring	Filter Kit, Filter, Dichtungs, O-Ring	Kit de filtre, filtre, joint, joint torique	Suntec, A2L/AT/AL 75/95 H23	0011457003
8 Magnetventil kompl.	Solenoid valve compl.	Magnetventil kompl.	Électrovanne, Étape 1, compl.	Suntec	0011994601
9 Spole magnetventil	Coil, solenoid valve	Spule, magnetventil	Bobine, électrovanne	Suntec	0011597101
12 Magnetventilblock kompl.	Solenoid valve block compl.	Magnetventilblock kompl.	Jeu d'électrovanne compl.		0091994701
13 Magnetventilkabel, steg 1, 2	Cable, solenoid valve, step 1,2	Kabel, Magnetventil, Stufe 1,2	Câble, électrovanne, Étape 1,2		0011597503
16 Nippel	Nipple	Nippel	Raccord	1/8	0011842301
17 Bussning	Bushing	Hülse	Bague		0011411302
18 Pump, med kabel	Pump, with cable	Pumpe, mit Kabel	Pompe, avec câble	ALEV 75CK	0092026437

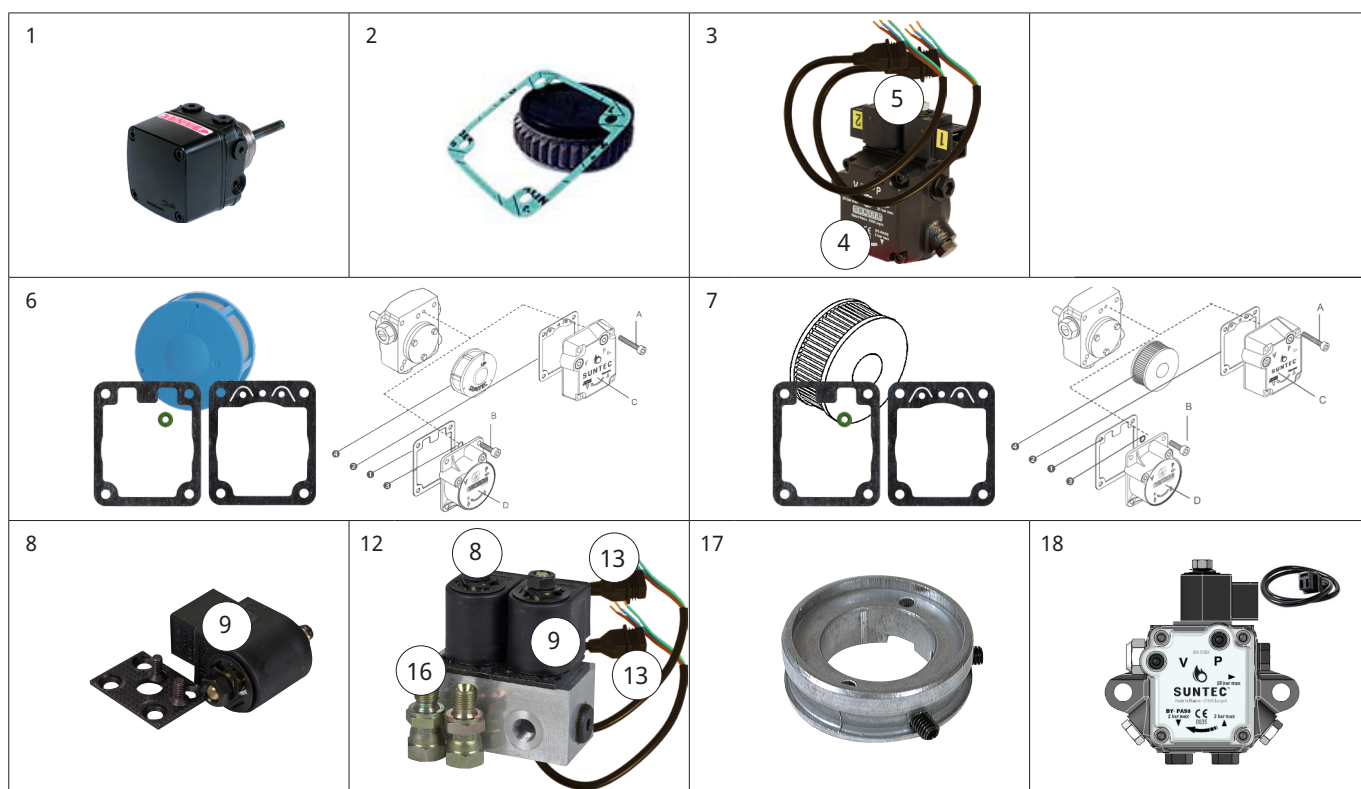





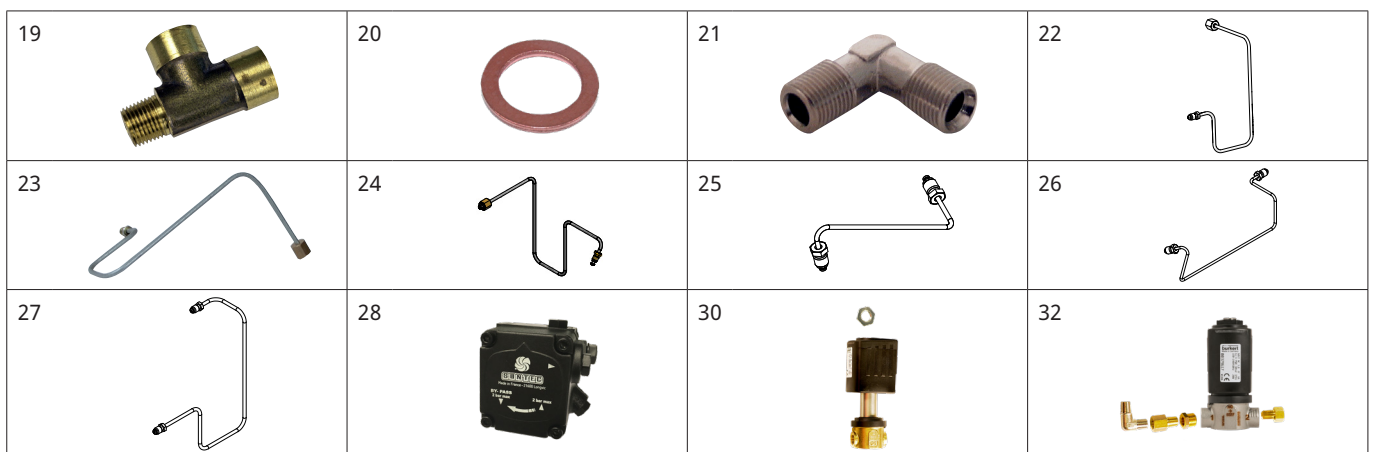

5. Pump - Pump - Pumpe - Pompe

Namn	Name	Name	Nom	Information	Artikel nr
19 Nippel, t-koppling	Nipple, t-coupling	Nippel, T-kupplung	Raccord en T	G1/8xG1/8xR1/8, B 45 A2.2H	0011959401
20 Kopparkpackning	Copper gasket	Kupferdichtung	Joint en cuivre	10.2x14x1,5	0011021228
21 Vinkelkoppling	Elbow	Winkelkupplung	Coude	R1/8xG1/8x60GR.KO	0011840401
22 Förbindelserör	Connecting pipe	Öldruckrohr	Conduite de raccordement	II PUMP-ISA B45	0011939411
23 Förbindelserör	Connecting pipe	Öldruckrohr	Conduite de raccordement	II PUMP-ISA B45	0011939511
24 Förbindelserör	Connecting pipe	Öldruckrohr	Conduite de raccordement	PUMP-MV B45	0012132801
25 Förbindelserör	Connecting pipe	Öldruckrohr	Conduite de raccordement	A2L-REG B45-2H	0011948401
26 Förbindelserör	Connecting pipe	Öldruckrohr	Conduite de raccordement	PUMP-MV B45 2.2H	0012132401
27 Förbindelserör	Connecting pipe	Öldruckrohr	Conduite de raccordement	PUMP-MV B45 2.2	0012132301
28 Pump	Pump	Pumpe	Pompe	RME, DV67C 7313-3P 2-3P, B 45	0011367539
30 Magnetventil	Solenoid valve	Magnetventil	Électrovanne	1/4" 240V 50Hz	0012118201
32 Magnetventil, rostfritt, kit	Solenoid valve, stainless, kit	Magnetventil, Edelstahl, set	Kit, électrovanne, inoxydable	RME, 1/4" 240V 50Hz	0012119203

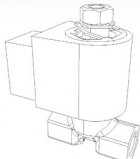

5. Pump - Pump - Pumpe - Pompe

Namn	Name	Name	Nom	Information	Artikel nr
33 Magnetventil, rostfritt	Solenoid valve, stainless	Magnetventil, Edelstahl	Électrovanne, inoxydable	RME, 1/4" 240V 50Hz	0012118203
35 Hydraulslang	Hydraulic hose	Hydraulischer, Ölschlauch	Tuyau hydraulique	1/8 L=370	0012087601
35 Hydraulslang	Hydraulic hose	Hydraulischer, Ölschlauch	Tuyau hydraulique	1/8 L=230	0012087602
38 Oljeslang	Flexible pipe	Ölschlauch	Flexible	Viton, G1/4x900xG1/4	0012083006
40 Oljeslang med Värmskyddsslang	Flexible pipe with Heat protection hose	Ölschlauch mit Hochtemperatur Isolierband PST	Flexible avec Tuyau de RME, protection thermique Viton,G1/4x900xG1/4		0012124406
42 Magnetventil	Solenoid valve	Magnetventil	Électrovanne	Suntec, 1/8" SL1V 2807	0012119401
44 Magnetventilkabel, steg 1, steg 2	Cable, solenoid valve, step 1, step 2	Kabel, Magnetventil, Stufe 1, Stufe 2	Câble, électrovanne, Étape 1, Étape 2	Danfoss, L=900 mm	0011597506

33		35		38		40	
42		44					

6. Elkomponenter - Electrical - Elektrische - Électriques

Namn	Name	Name	Nom	Information	Artikel nr
1 Reläbox	Control box	Steuergerät	Boite de relais	LAL 1.25	0091493901
2 Reläsockel kompl.	Base, control box compl.	Unterteil, Steuergerät kompl.	Socle de raccordement compl.	LAL 1.25	0011494200
4 Reläbox	Control box	Steuergerät	Boite de relais	LOA 24	0091559504
6 Reläbox	Control box	Steuergerät	Boite de relais	LMO24.255.C2E	0092024202
7 Reläsockel kompl.	Base, control box compl.	Unterteil, Steuergerät kompl.	Socle de raccordement compl.	LOA/LMO	0091559600
9 Reläbox	Control box	Steuergerät	Boite de relais	Satronic TF 832.3	0091781007
10 Reläsockel kompl.	Base, control box compl.	Unterteil, Steuergerät kompl.	Socle de raccordement compl.	Satronic	0091991001
13 Styrautomat	Automatic control unit	Automatisches Steuergerät	Module de commande automatique	BP230UVFR-S3 B	0012122601
15 Fotomotstånd kompl.	Photoresistor compl.	Fotowiderstand kompl.	Cellule photorésistante compl.	QRB1B	0091240900
16 Fläns, fotomotstånd	Flange, photoresistor	Flansch, fotowiderstand	Bride, cellule photorésistante	QRB1	0011240501
17 Fotomotstånd	Photoresistor	Fotowiderstand	Cellule photorésistante	MZ 770	0439029567
18 Fläns, fotomotstånd	Flange, photoresistor	Flansch, fotowiderstand	Bride, cellule photorésistante	MZ	0039011303



6. Elkomponenter - Electrical - Elektrische - Électriques

Namn	Name	Name	Nom	Information	Artikel nr
21 Flamdetektor till brännare med LMO/LMV efter serienummer 2498749	Flame detector for burners with LMO/LMV after serialnumber 2498749	Flammendetektor für Brenner mit LMO/LMV nach der Seriennummer 2498749	Détecteur de flamme pour les brûleurs avec LMO/LMV après le numéro de série 2498749	QRB4A	0092119614
22 Fläns, fotomotstånd	Flange, photoresistor	Flansch, fotowiderstand	Bride, cellule photorésistante	QRB4A	0011240502
23 Hållare fotomotstånd	Holder photoresist	Erziehende Fotowiderstand	Maître de maison photoresist	QRB4A	0011240702
24 Flamdetektor	Flame detector	Flammendetektor	Détecteur de flamme	QRB4B	0092119623
25 Flamdetektor	Flame detector	Flammendetektor	Détecteur de flamme	UV5-2	0012122901
26 Fläns, fotomotstånd	Flange, photoresistor	Flansch, fotowiderstand	Bride, cellule photorésistante	UV5-2	0012126601
30 Kontaktor	Contacteur	Schütz	Contacteur	LC1D09P7	0012143101
32 Motorskydd	Thermal overload protection	Überstromschutz	Déclencheur à maxima d'intensité	1,0-1,6A	0012143202
32 Motorskydd	Thermal overload protection	Überstromschutz	Déclencheur à maxima d'intensité	1,6-2,5A	0012143206
34 Kontaktdon 4+7 pol kompl.	Plug-in contact 4+7-pole compl.	Steckerteil 4+7-polig kompl.	Fiche de prise de courant 4+7-polaire compl.		0011933305
35 7 pol, hane	7-pole, male	7-polig, Stecker	7-polaire, mâle		0011558500
36 7 pol, hona	7-pole, female	7-polig, Buchsenteil	7-polaire, femelle		0011558603
37 4 pol, hane	4-pole, male	4-polig, Stecker	4-polaire, mâle		0011919701

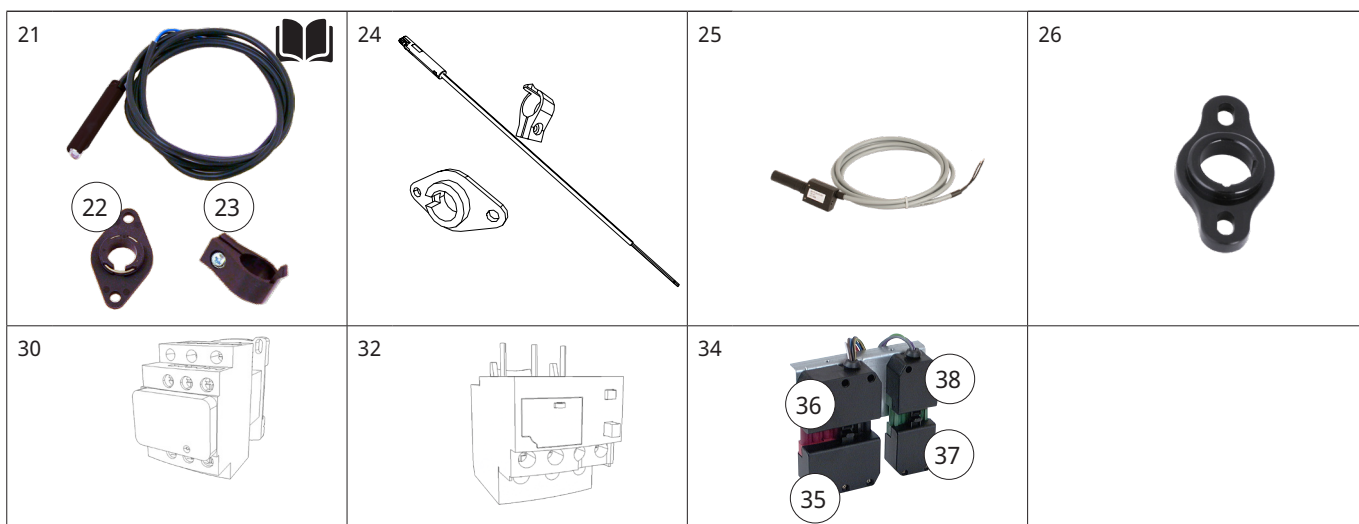

6. Elkomponenter - Electrical - Elektrische - Électriques

Namn	Name	Name	Nom	Information	Artikel nr
38 4 pol, hona	4-pole, female	4-polig, Buchsenteil	4-polaire, femelle		0011919801
40 Indikeringslampa, grön	Indication lamp, green	Anzeigelampe, grün	Voyant lumineux, vert		0011721103
42 Strömbrytare	Switch	Schalter	Interrupteur	0-I	0012132201
44 Strömbrytare	Switch	Schalter	Interrupteur	I-II	0012132202
45 Omkopplare, manuell-automatisk	Switch, manuel-automatic	Umschalter, manuell-automatisch	Commutateurs, manuel-automatique		0012132203
46 Timräknare	Time meter	Betriebsstunden-zähler	Compteur horaire		0011767801
48 Euro-kontakt, brännare extern reset (Tillbehör)	Plug-in contact, burner external reset (optional)	Eurostecker, Brenner Externe Rückstellung (optional)	Prise européenne, réarmement externe (en option), brûleur		0092062401
51 Transformator	Transformer	Transformator	Transformateur	FIDA	0011804601
52 Kabel, transformator	Cable, transformer	Kabel, Transformator	Câble, transformateur	FIDA L=450mm	0011804701
54 Resistanständkabel	Ignition cable	Zündkabel	Câble H.T	L=250 mm	0012074925
54 Resistanständkabel	Ignition cable	Zündkabel	Câble H.T	L=350 mm	0012074935
56 Transformator	Transformer	Transformator	Transformateur	EBI	0092064301
58 Kabel, transformator	Cable, transformer	Kabel, Transformator	Câble, transformateur	EBI L=500mm	0012062004

40		42		44		45	
46		48					
51		52		54			
56		58					

6. Elkomponenter - Electrical - Elektrische - Électriques

Namn	Name	Name	Nom	Information	Artikel nr
70 Effektregulator	Power control	Leistungsregler	Régulateur de puissance	R316 T, PT 100	0012052601
70 Effektregulator, tryck	Power control, pressure	Leistungsregler, druck	Régulateur de puissance, pression	R316 T, 0-10V	0012052602
73 Transformator	Transformer	Transformator	Transformateur	HDR-15-24 220 VAC/24 VDC	0012133901
75 Givare	Sensor	Fühler	Sonde	PT 100	0011581902
77 Jumo tryckgivare	Jumo pressure transmitter	Jumo Drucktransmitter	Jumo transmetteur de pression	0-1 bar	0011581905
77 Jumo tryckgivare	Jumo pressure transmitter	Jumo Drucktransmitter	Jumo transmetteur de pression	0-10 bar	0011581906
77 Jumo tryckgivare	Jumo pressure transmitter	Jumo Drucktransmitter	Jumo transmetteur de pression	0-16 bar	0011581907
78 Effektregulator, kapslad	Power regulator in device box	Leistungsregler im Gerätekasten	Régulateur de puissance dans la boîte de l'appareil	PT 100, R316 T	0012134903
78 Effektregulator, kapslad, tryck	Power regulator in device box, pressure	Leistungsregler im Gerätekasten, druck	Régulateur de puissance dans la boîte de l'appareil, pression	R316 T	0012134904
83 Jumo termoelement	Jumo thermocouple	Jumo Thermoelement	Jumo thermocouple	-200 - 1500	0011581910
85 Jumo klämförskruvning termoelement	Jumo compression fitting thermocouple	Jumo, Klemmverschraubung für Thermoelemente	Jumo raccord à vis de serrage pour thermocouples		0011581911

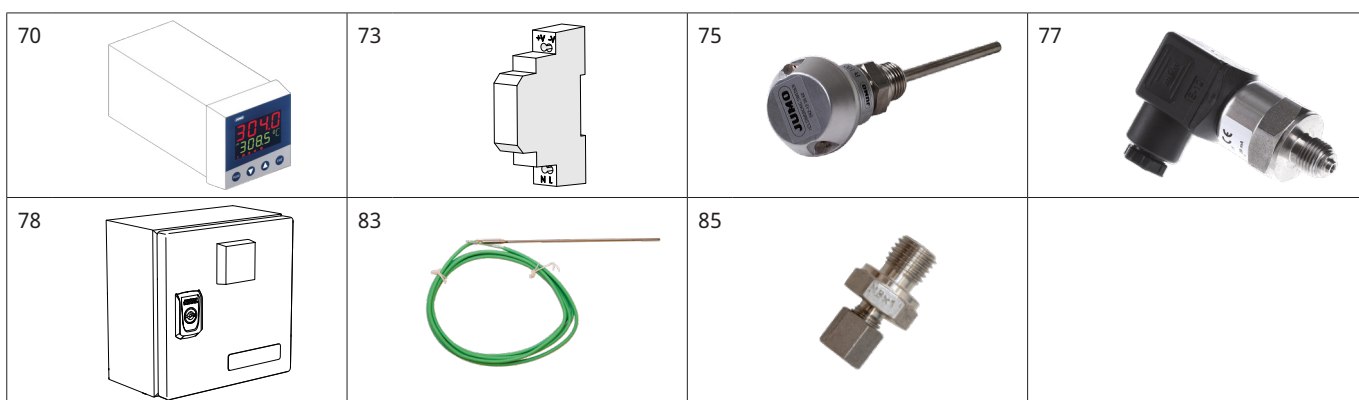

7. Fläkthus - Fan housing - Lüftergehäuse - Carter de ventilateur

Namn	Name	Name	Nom	Information	Artikel nr
1 Lock	Cover	Deckel	Couvercle		001176490105
2 Packning, lock	Gasket, cover	Dichtung, Deckel	Joint, couvercle		0011778301
3 Skyddsgaller	Protective grating	Schutzgitter	Grille de protection		0011930201
5 Kåpa, inspektionsglas	Cover, inspection glass	Haube, Schauglas	Capot, viseur de flamme		001179630205
6 Inspektionslock	Inspection cover	Deckel, Schauglas	Couvercle, viseur de flamme		0011708001
8 Inspektionsglas	Inspection glass	Schauglas	Voyant liquide		0011808801
9 Packning, inspektionsglas	Gasket, inspection glass	Dichtung, Inspektionsglas	Joint, verre d'inspection		0011795301
10 Säkringsring	Locking ring	Sicherungsring	Circlip		0011801801

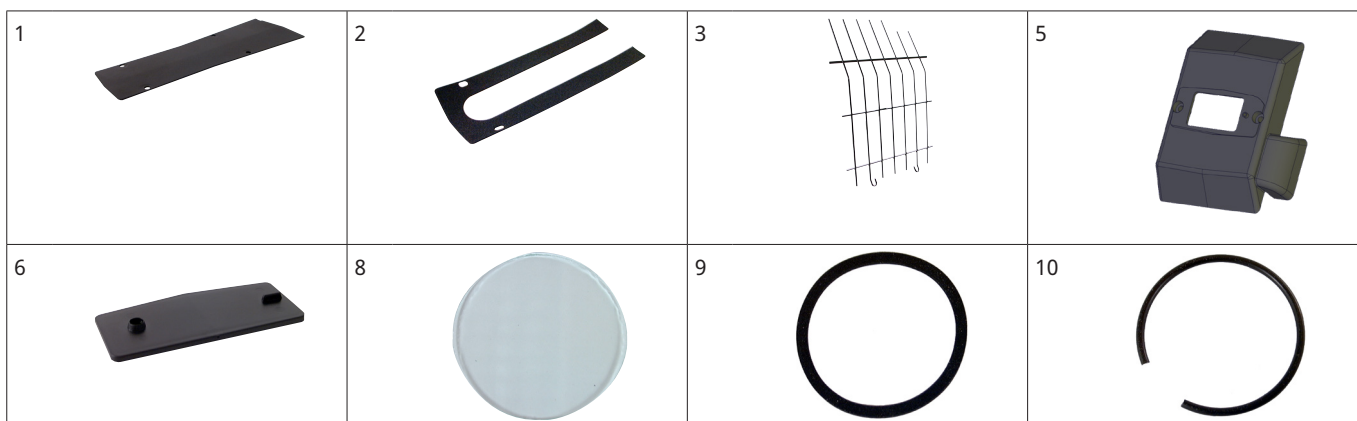

8. Luftreglering - Air control - Luftsteuerung - Régularisation à air

Namn	Name	Name	Nom	Information	Artikel nr
1 Spjällmotor	Damper motor	Klappenmotor	Moteur de volet	SQN75.294A21B, LAL	0011942303
1 Spjällmotor	Damper motor	Klappenmotor	Moteur de volet	SQN75.244A21B, LOA/LMO	0011942304
4 Reglerdon	Adjustment device	Regelgerät	Dispositif de réglage	B 45 A2.2H, B45i	0091756514
5 Fjäder, kompl. reglerdon	Spring, compl. adjustment device	Feder, kompl. Regelgerät	Ressort, compl. dispositif de réglage		0011379901
7 Fästplatta luftspjäll	Covering plate, air damper	Deckplatte, Luftklappe	Plaque de recouvrement, volet d'air	B 45 A, B 45 A2.2H	001185280105
7 Fästplatta luftspjäll	Covering plate, air damper	Deckplatte, Luftklappe	Plaque de recouvrement, volet d'air	B45 2A, B 45 A2.2R, B 45 A2.2	001179780105
8 Pinnskruv	Stud screw	Stiftschraube	Vis à goupille		0011920301
10 Luftspjäll kompl.	Air damper compl.	Luftklappe kompl.	Volet d'air compl.	B 45 A, B 45 A2.2H	0091886602
10 Luftspjäll kompl.	Air damper compl.	Luftklappe kompl.	Volet d'air compl.	B 45 A2.2R, B 45 A2.2	0091886601
12 Mät nipple	Test nipple	Messnippel	Raccord de mesure	R1/8"xØ8	0012074501
13 Länkkarm kompl.	Slewing bracket compl.	Gelenkarm kompl.	Pivot compl.		0011947001
14 Ändavslutning	Covering plug	Endstück	Bouchon de protection		0011810301

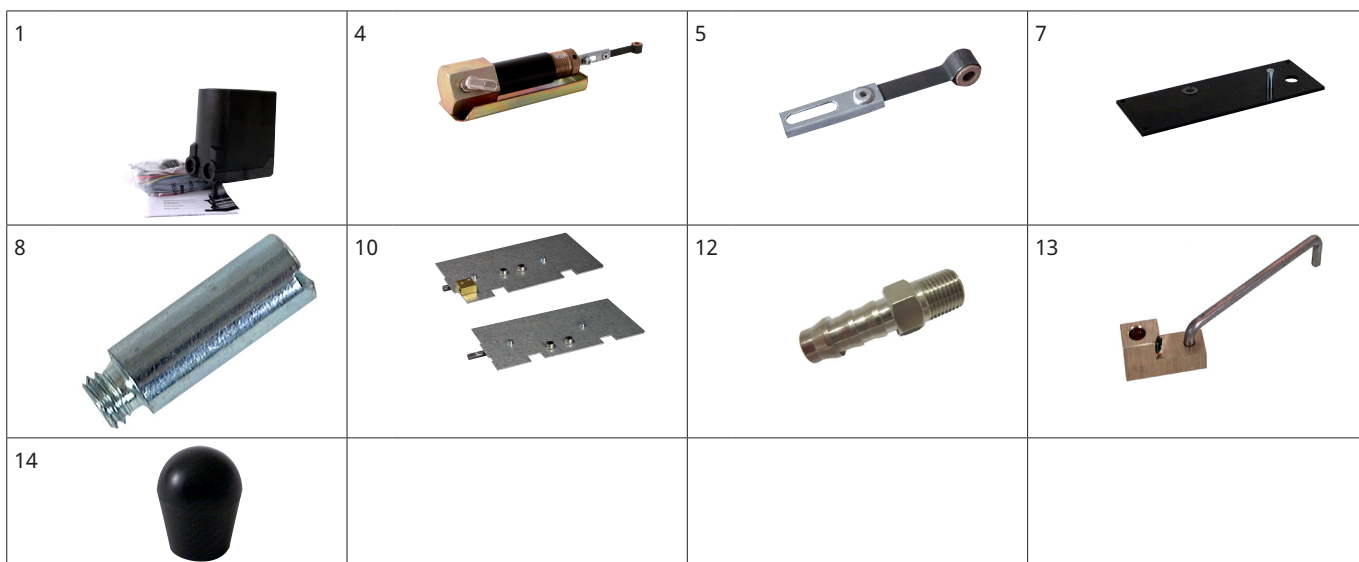

9. Övrigt - Sundries - Verschiedenes - Divers

Namn	Name	Name	Nom	Information	Artikel nr
1 Oljeslang	Flexible pipe	Ölschlauch	Flexible	1/4 L=900 mm.	0012110015
4 Oljefilter, ALU För Eo 1, HVO/XTL och FAME/RME	Oil filter, ALU For Fuel oil, HVO/XTL and FAME/RME	Ölfilter, ALU Für Heizöl, HVO/XTL und FAME/RME	Filtre d'huile, ALU Pour l'huile de chauffage, HVO/XTL et FAME/RME	3/8RP 100µM 70311AE Viton #0011429303	0011429313
6 Packningssats för filter 11429303, 11429311 och 11429313	Gasket set for filter 11429303, 11429311 and 11429313	Dichtungssatz für Filter 11429303, 11429311 und 11429313	Kit d'emballage de filtres 11429303, 11429311 et 11429313	3203V, Viton #11885304	0011885314
8 Automatisk oljeavluftare med filter Kerosin, För eldningsolja med max 20% biolja, HVO/XTL Rsk nr: 6469526	Automatic oil de- aerator with filter	Automatische Ontluchter mit Filter	Purgeur Automatique avec filtre	<110 l/h, OV COMBI TC3110	0011748902
10 Filter för 11748902 och 11709301	Filter for 11748902 and 11709301	Filter für 11748902 und 11709301	Filtre pour 11748902 et 11709301	50-75 µm	0011758901

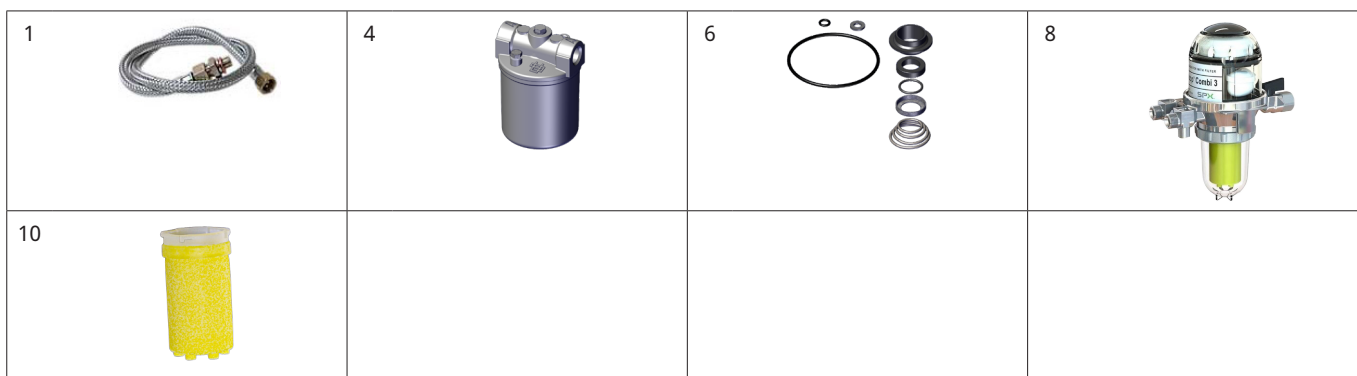

9. Övrigt - Sundries - Verschiedenes - Divers

Namn	Name	Name	Nom	Information	Artikel nr
20 Magnetventil kontiunerlig fläkt för pump med ett munstycksuttag	Solenoid valve continous fan for pump with one nozzle outlet	Kontunuirliches Gebläse. Montage an Ölpumpe mit einen Düsenausgang	Ventilation continue. Montage sur pompe avec une ligne gicleur	1/8"	0011923003
22 Magnetventil kontiunerlig fläkt för pump med två munstycksuttag	Solenoid valve continous fan for pump with two nozzle outlet	Kontunuirliches Gebläse. Montage an Ölpumpe mit zwei Düsenausgang	Ventilation continue. Montage sur pompe avec une deux gicleur	1/8"	0011923004
26 Strömbrytare säkerhetsred	Switch Safety button	Schalttaste wechseln	Bouton de sécurité du commutateur		0012114101
27 Strömbrytare	Switch	Schalter	Interrupteur	0-I	0012114002
28 Strömbrytare, 3-pol	Switch, 3-pole	Schalter, 3-polig	Interrupteur, 3-polaire		0012114103
30 Distanshylsa	Spacing socket	Distanz-Hülse	Douille d'écartem.	LMV, 12x10x5,5	0011567802
32 Displaykabel	Cable, Display	Kabel, Display	Cable, Display	L=626,4	0012106302
34 Magnetventilkabel	Cable, solenoid valve	Kabel, Magnetventil	Câble, électrovanne	L=1300 mm.	0011597510
37 Oljetryckvakt kompl.	Oil pressure switch compl.	Öldruckschalter kompl.	interrupteur de pression d'huile compl.	J/K	0012114301
39 Motorkabel-Kontaktor	Motor-Contactor Cable	Motor-Kontaktor kabel	Moteur-Contacteur Cable		0012102808
41 Pump, med kabel	Pump, with cable	Pumpe, mit Kabel	Pompe, avec câble	AS67C 7446-6P, B45i	0092026412

J/K - J/K - J/K - J/K - J/K - J/K - J/K - J/K - J/K - J/K - J/K - J/K - J/K - J/K - J/K - J/K - J/K - J/K - J/K - J/K					
20		22		26	
28		30		32	
37		39		41	

9. Övrigt - Sundries - Verschiedenes - Divers

Namn	Name	Name	Nom	Information	Artikel nr
43 Tryckvakt	Pressure switch	Druckwächter	Pressostat	LGW50A2 2,5-50 mbar, B45i	0011531907
45 Kabelgenomföring	Cable inlet	Kabeldurchführung	Douille de passage de câble		0011589802
47 Plint	Terminal	Klemmen	Bornier	ST 2,5 TWIN, 3x400V	913146401
49 Plint	Terminal	Klemmen	Bornier	ST 2.5 QUATTRO BU	584359002
52 Plint	Terminal	Klemmen	Bornier	ST 2,5	913145401
54 Plint	Terminal	Klemmen	Bornier	ST 2.5 QUATTRO PE	584359003
56 Ändstöd	End support	Support beenden	Fin du support	D-ST2,5 TWIN	913190402
57 Ändbricka	End plate	Endplatte	Plaque d'extrémité		586938401
58 Ändbricka	End plate	Endplatte	Plaque d'extrémité	2.5 QUATTRO	586936405
60 Display	Display	Display	Afficheur	T.LMV AZL23.00A9	0012101101
62 Säkringsplint 5x20	Fuse terminal	Sicherungsklemme	Borne à fusible	5x20	0012103301
64 Styrautomat LMV37 Programversion 8	Control box LMV37 Software version 8	Steuerautomat LMV37 Softwareversion 8	Boîte Autopilot LMV37 version du logiciel 8	B45i A2.2H	0012101008
65 Modbusenhet (utgående artikel)	Modbus unit (outgoing article)	Modbusgerät (ausgehendes Produkt)	Unité Modbus (produit périmé)	OCI 412	0092101901
66 Hydraulik skydd kompl.	Hydraulic protection compl.	Hydraulischer Schutz kompl.	Protection hydraulique compl.	B 45-B 80, J/K	009209500105
68 Transportoljepump	Fuel transfer unit	Motorpumpen-gruppen	Groupe motorpompe	FTU AEV97C	0012121101
69 Pump	Pump	Pumpe	Pompe	AEV97C, Max 2 mbar	0012121191

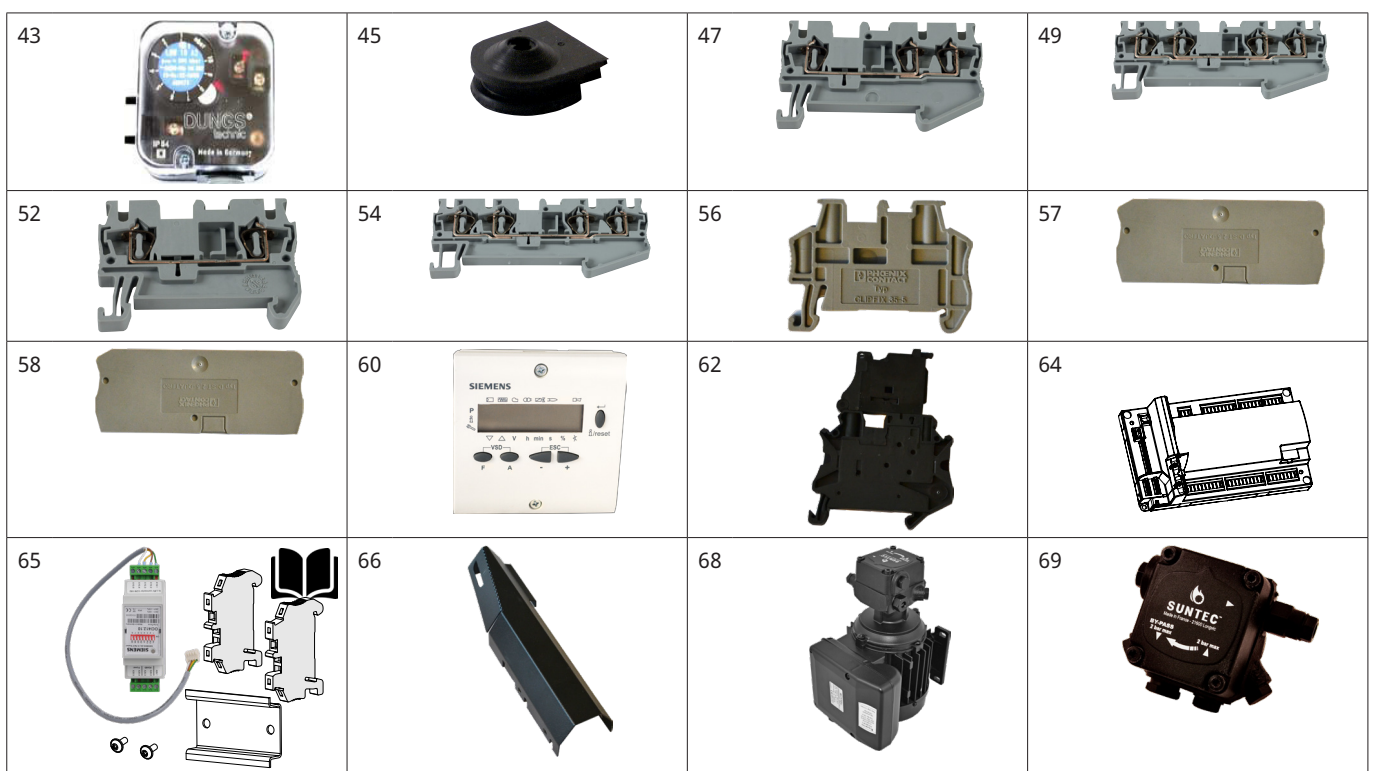



CTC AB Box 309 SE-341 26 Ljungby

info@bentone.se +46 372 88 000

www.bentone.se