



Providing sustainable energy solutions worldwide

Installation- and maintenance instruction
MOL795 T3L 373 2H

Table of contents

1. GENERAL	8
1.1 Description B55/B65	8
2. TECHNICAL DATA	10
2.1 Type designation B55-2H/B55-2/B55-2R/B55-3R/ B65-2H/B65-2/B65-2R/B65-3R	10
2.2 Dimensions	10
2.3 Recommended nozzle and pressure	10
2.4 Output range and nozzles recommended	10
2.5 Working field	11
2.6 Nozzle table	12
2.7 Nozzle table	13
3. INSTALLATION	14
3.1 Acceptance inspection	14
3.2 Preparations for installation	14
3.3 Distribution of oil	14
3.4 Electrical connections	14
3.5 Choice of nozzle	14
3.6 Setting of the brake plate and air flow	14
3.7 Burner installation	15
3.7.1 Hole pattern	15
3.8 Installing the burner	15
3.9 Oil lines	15
3.10 Electrical connections	15
4. BASIC SETTINGS	16
4.1 Typical basic settings for B65-2H/B65-2 B65-2R/B65-3R	16
4.2 Set values for nozzle assembly B55	17
4.3 Set values for nozzle assembly B65	17
4.4 Set values for air damper B55	17
4.5 Set values for air damper B65	17
4.6 Nozzle assembly regulation – fixed brake plate	18
4.7 Nozzle assembly regulation – adjustable brake plate	18
4.8 Hydraulic air adjustment	18
4.9 Damper motor 2-Stage	19
4.10 Damper motor 3-Stage	20
5. MAINTENANCE	21
5.1 Servicing the burner device	21
5.2 Adjusting the ignition electrodes and brake plate	21
5.3 Servicing the air damper	22
5.4 Replacing the damper motor	22
5.5 Replacing the oil pump B55/B65	23

6. INSTRUCTIONS PUMP	24
6.1 TYPE 95 & 125	24
6.2 Components	24
6.3 Mounting/dismounting by-pass plug	24
6.4 Purging	24
6.5 Replacing the filter	24
6.6 Function Danfoss RSA 95 - 125	25
6.7 Suction line tables	26
7. ELECTRIC EQUIPMENT	27
7.1 Wiring diagram LMO24.255...(B55-2H/B65-2H)	27
7.2 Wiring diagram LAL 1... (B55-2/B55-2R/B65-2/B65-2R)	32
7.2.1 List of components LAL 1... (B55-2/B55-2R/B65-2/B65-2R)	33
7.2.2 Function LAL 1...	34
7.3 Wiring diagram LAL 1... (B55-3/B65-3)	35
7.4 Wiring diagram LAL 1... (B55-3/B65-3 med regulator R316T)	36
7.4.1 List of components LAL 1... (B55-3/B65-3 och B55-3/B65-3)	37
7.4.2 Function LAL 1...	38
7.4.3 Control programme under fault conditions and lock-out indication LAL 1...	39
7.4.4 Technical data LAL 1...	39
8. FAULT LOCATION	40
8.1 Burner will not start	40
8.2 Burner will not start after normal use	40
8.3 Delayed ignition, burner starts; pulsation	40
9. DECLARATION OF CONFORMITY	41

Important to think about!

Read this manual

- This manual should be followed by anyone who for any reason performs work on the installation or its component parts.
- The manual is especially intended for authorized personnel.
- The manual is to be considered as part of the burner and must always be kept in the vicinity of the installation site.
- Enertech recommends that the burner be shut down when the oil tank is filled, and for six hours thereafter, to reduce the risk of blockages.

Safety instructions

The electrical installation must be carried out according to the high voltage provisions and be performed in a professional manner, so that the risk of oil leakage, fire or personal injury is avoided

Warnings

- The manual must be read before installation and start-up.
- This manual should be followed by anyone who for any reason performs work on the installation or its component parts.
- The manual is to be considered as part of the burner and must always be kept in the vicinity of the installation site.
- Ensure that the fresh air inlet to the room where the burner is located is always open.
- The burner may only be installed by authorized personnel.
- Check that the burner is suitable for the boiler type.
- The burner must be installed in accordance with local legislation regarding electrical safety and fuel supply.
- The burner is designed for oil viscosities ranged between 1.2 and 8.0 cSt at 20°C.
- The burner must be protected by at most a 10 A fast-blow or 6.3 A slow-blow fuse.
- No burner safety system may be disconnected.
- The installation engineer must ensure that the boiler room is supplied with sufficient fresh air in accordance with local standards.
- Cut the power and shut-off the fuel supply before performing service.
- Enertech recommends that the burner be shut down when the oil tank is filled, and for six hours thereafter, to reduce the risk of blockages.
- The external temperature of the burner's component parts may exceed 60°C.
- Ensure that the burner is protected from water spills, as its design will not withstand such.
- Oil filters should be used.
- Only use spare parts recommended by Enertech.



Electrical safety

- If any electrical connections are made other than those recommended by Enertech, there is a risk of personal injury and equipment damage.
- The electrical installation must be carried out according to the high voltage provisions and be performed in a professional manner, so that the risk of oil leakage, fire or personal injury is avoided.
- The installation engineer must be especially careful to ensure that no electrical wiring or oil lines are pinched or damaged during installation or service

Assembly and Service

- If the boiler is equipped with an inspection hatch, the hatch should be fitted with an interlock.
- Filters must be fitted to the oil supply line.
- Shut-off cocks must be fitted to the oil supply line.
- Oil lines must adhere to the current national standards of each respective country.

Condensation in the flue

A modern burner works with lower surplus air and also often with smaller nozzles than older types. This raises efficiency but also increases the risk of condensation in the flue. The risk increases if the cross section of the flue channel is too great. Flue gas temperatures should be above 60°C measured 0.5 m from the flue chimney.

If the burner is used together with a condensing boiler, working condensing, the installation must have a chimney that manages this type of operating conditions.

Measures to increase the temperature

- Insulate the flue in cold loft space.
- Install an insert flue.
- Install a Dragex draught stabilizer or equivalent (which dries and entilates the flue during shutdown periods).

Adjusting the burner

In order to achieve correct adjustment flue gas analysis and temperature measurements must be carried out. Otherwise there is a risk of soot build-up, poor efficiency or condensate precipitation in the flue..

1. GENERAL

1.1 Description B55/B65

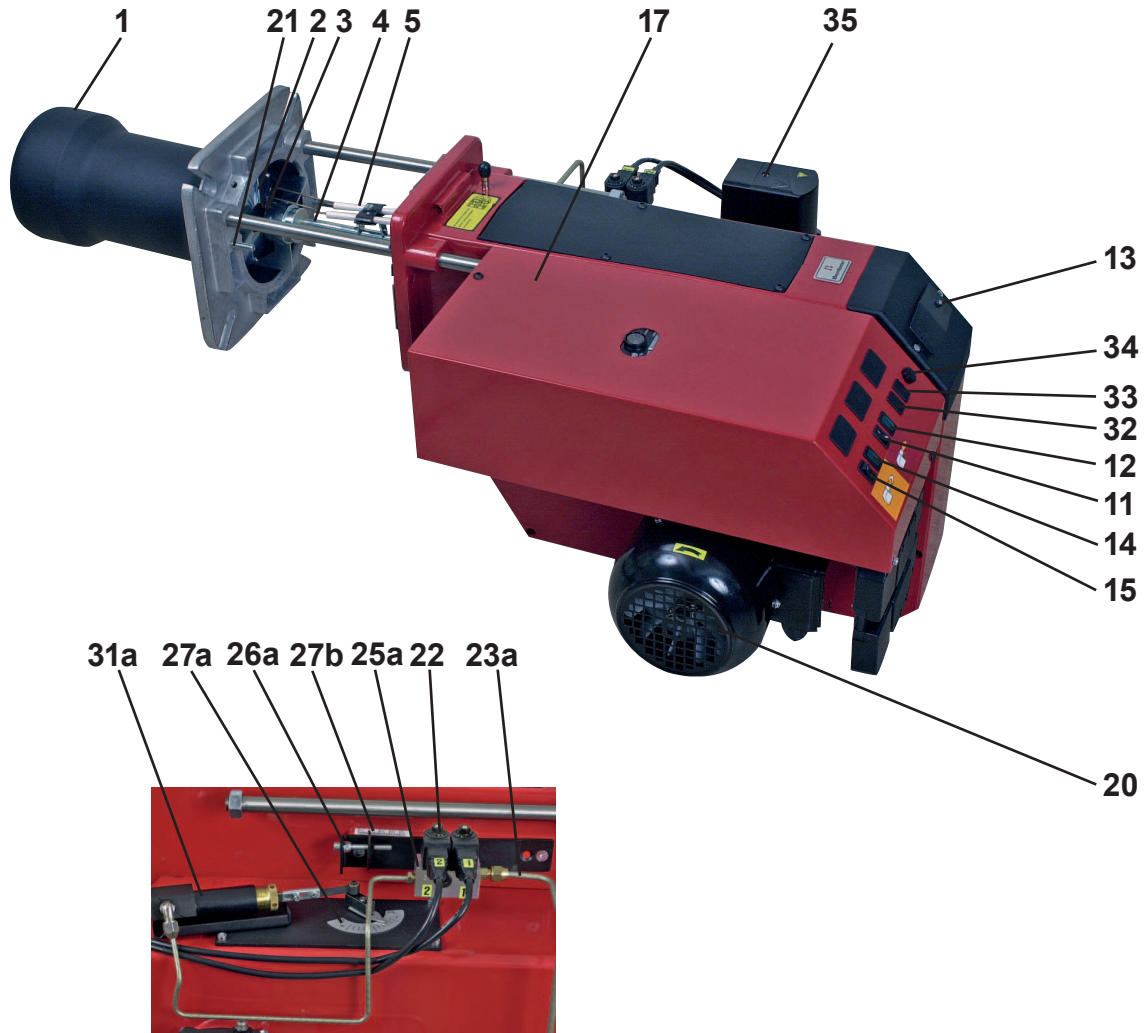

Components

- | | | |
|-----------------------------|---------------------------------------|------------------------------------|
| 1. Flame cone | 15. Switch 0-I | 27a. Scale, air regulation |
| 2. Brake plate | 17. Electric panel | 27b. Scale, nozzle assembly |
| 3. Nozzle | 20. Motor | 31a. Adjustment device, air damper |
| 4. Nozzle assembly | 21. Locking device, flange | 32. Switch II-III |
| 5. Ignition electrodes | 22. Solenoid valves | 33. Indicating lamp Stage 3 |
| 11. Switch I-II | 23a. Connecting pipe | 34. Fuse |
| 12. Indicating lamp Stage 2 | 25a. Solenoid valve bloc Stage 2 | 35. Damper motor |
| 13. Cover, inspection glass | 26a. Nozzle assembly adjustment fixed | |
| 14. Indicating lamp Stage 1 | | |

Description B55/B65

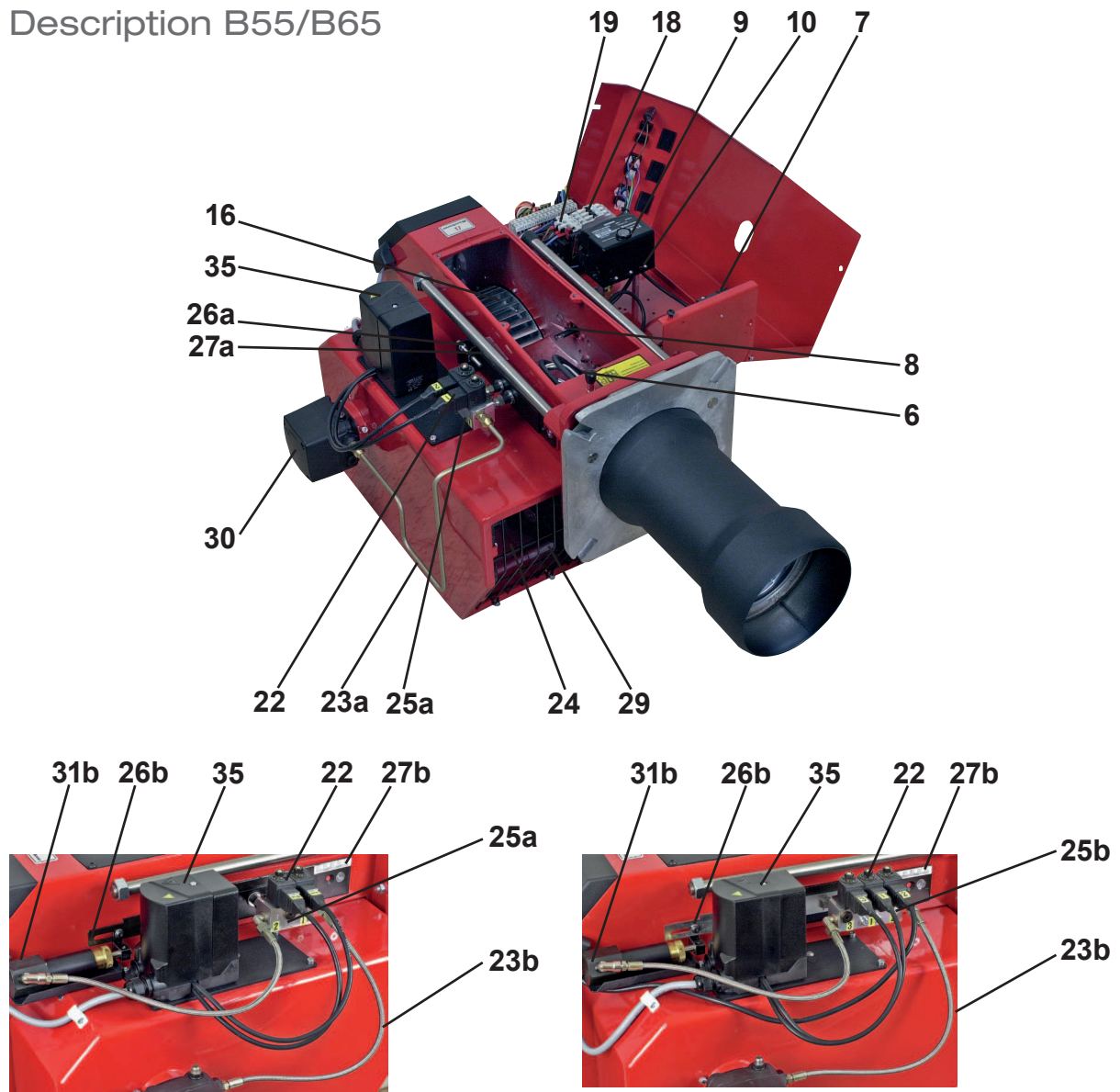

Components

- | | | |
|---------------------------------|---|---|
| 6. Ignition cables | 23a. Connecting pipe | 27a. Scale, air regulation |
| 7. Ignition transformer | 23b. Hydraulic hose | 27b. Scale, Nozzle assembly |
| 8. Photocell | 24. Air intake | 29. Air damper |
| 9. Control box | 25a. Solenoid valve bloc Stage 2 | 30. Pump |
| 10. Front plate, relay base | 25b. Solenoid valve bloc Stage 3 | 31b. Adjustment device, Nozzle assembly |
| 16. Fan wheel | 26a. Nozzle assembly adjustment fixed | 35. Damper motor |
| 18. Contactor | 26b. Nozzle assembly adjustment hydraul | |
| 19. Thermal overload protection | | |
| 22. Solenoid valve | | |

2. TECHNICAL DATA

2.1 Type designation B55-2H/B55-2/B55-2R/B55-3R/
B65-2H/B65-2/B65-2R/B65-3R

2.2 Dimensions

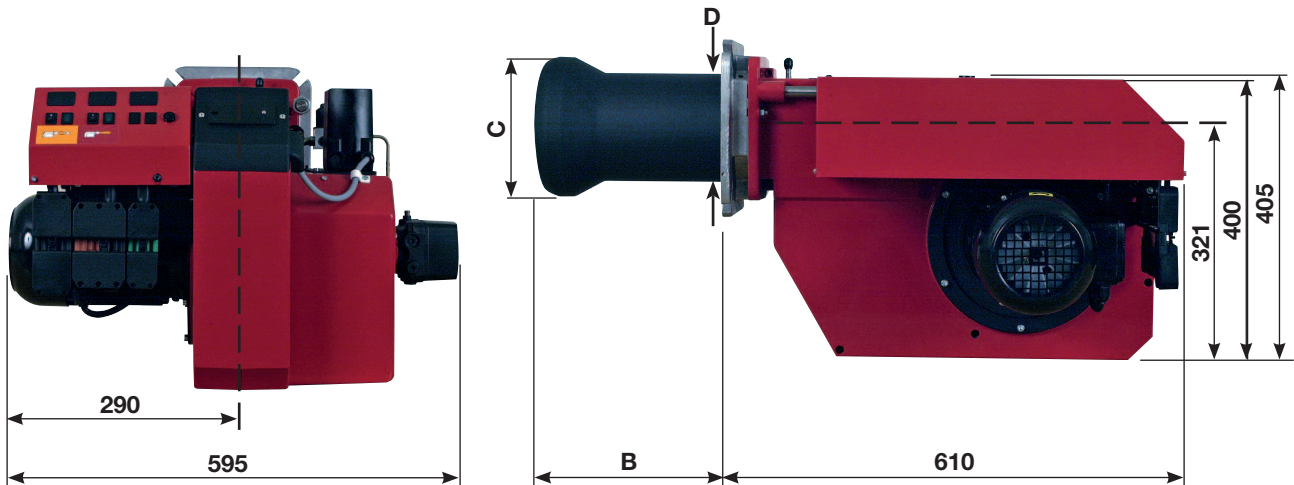

	Length of burner tube	Flange Measure B	Burner tube Measure C	Burner tube Measure D
B55				
Standard 1	303	273	160	155
Standard 2	403	373	160	155
Standard 3	503	473	160	155
B65				
Standard 1	288	258	200	155
Standard 2	388	358	200	155
Standard 3	488	458	200	155

2.3 Recommended nozzle and pressure

Because of the different boiler types, combustion chamber geometries and combustion chamber loads that exist, it is not possible to specify a given spray angle or spray pattern. It should be noted that the spray angle and spray pattern will vary depending on the pump pressure.

Nozzle

45°S Danfoss
45°B Danfoss
60°S Danfoss
60°B Danfoss

Pump pressure

4 bar (12 - 16 bar)

On burners equipped with hydraulic air control or optimization the oil pressure should not be less than 14 bar.

2.4 Output range and nozzles recommended

	Oljemängd	Effekt		Rekommenderat	munstycke	Rekommenderat
	kg/h	kW	Mcal/h	Vinkel	Danfoss	pumstryck
B55-2H, B55-2, B55-2R	14-67	166-795	143-685	45°-60°	S, B	14 bar
B55-3R	14-64	166-759	143-654	45°-60°	S, B	14 bar
B65-2H, B65-2, B65-2R	24-99	285-1174	246-1012	45°-60°	S, B	14 bar
B65-3R	24-99	285-1174	246-1012	45°-60°	S, B	14 bar

* The net calorific value of 11,86 kWh/kg for light oil has been used.

2.5 Working field

B55-2

14-67 kg/h
166-795 kW

— B55-2R
— B55-2H/B55-2
- - - Measured (test)

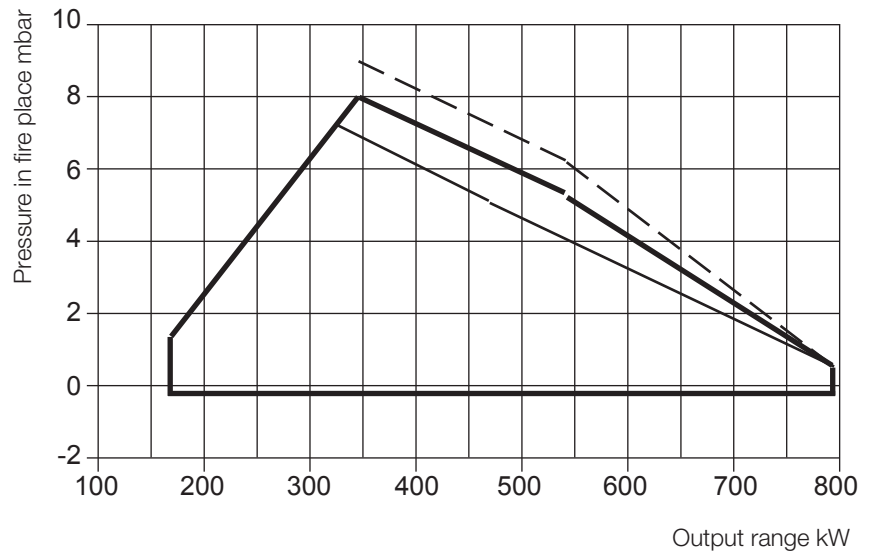

B55-3R

14-64 kg/h
166-759 kW

— B55-3R
- - - Measured (test)

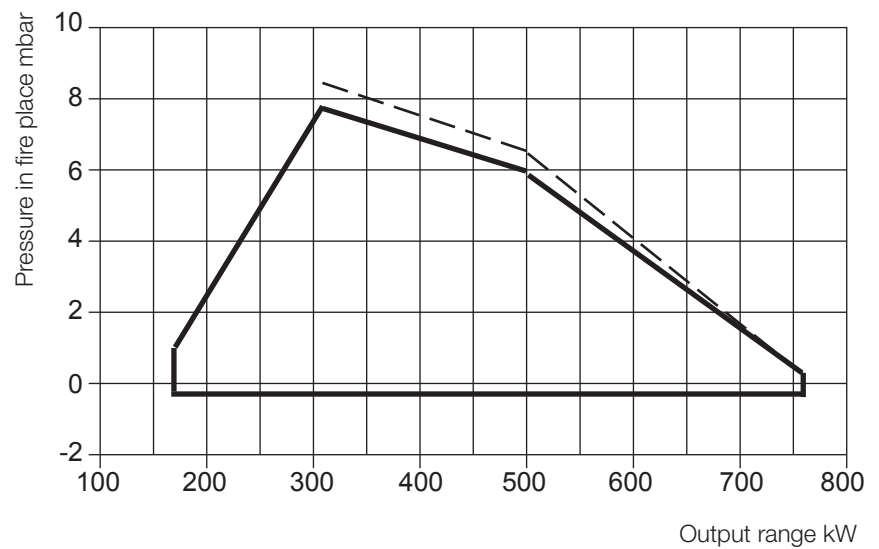

B65

24-99 kg/h
285-1174 kW

— B65
- - - Measured (test)

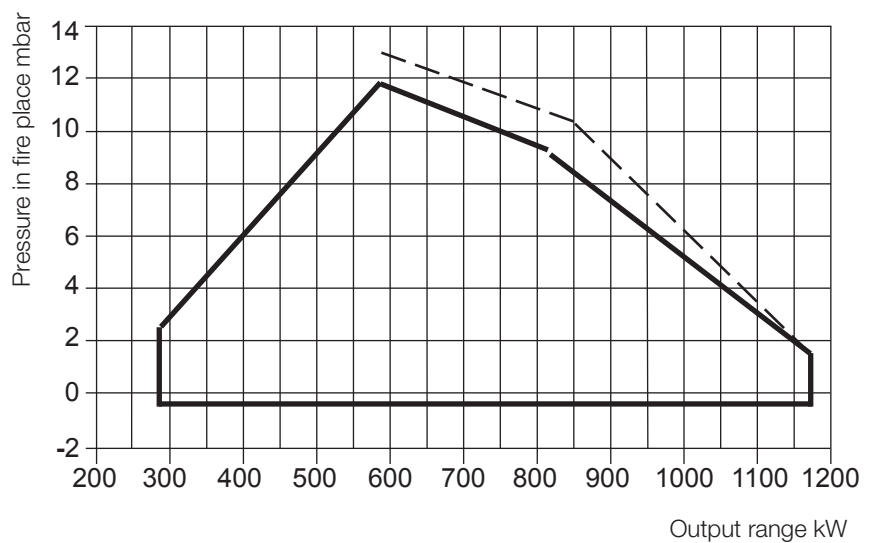

Unbroken line is the approved working field as per EN267.

2.6 Nozzle table

Pump pressure bar

Gph	10			11			12			13		
	kg/h	kW	Mcal/h	kg/h	kW	Mcal/h	kg/h	kW	Mcal/h	kg/h	kW	Mcal/h
2,75	10,24	121	104	10,73	127	109	11,21	133	114	11,67	138	119
3,00	11,16	132	114	11,71	139	119	12,23	145	125	12,73	151	130
3,50	13,03	154	133	13,66	162	139	14,27	169	146	14,85	176	151
4,00	14,89	176	152	15,62	185	159	16,31	193	166	16,97	201	173
4,50	16,75	199	171	17,57	208	179	18,35	218	187	19,10	226	195
5,00	18,62	220	190	19,52	231	199	20,39	242	208	21,22	252	216
5,50	20,48	243	209	21,47	255	219	22,43	266	229	23,34	277	238
6,00	22,34	265	228	23,42	278	239	24,47	290	250	25,46	302	260
6,50	24,20	287	247	25,37	301	259	26,51	314	270	27,58	327	281
7,00	26,06	309	266	27,33	324	279	28,55	339	291	29,70	352	303
7,50	27,92	331	285	29,28	347	299	30,59	363	312	31,83	377	325
8,00	29,79	353	304	31,23	370	318	32,63	387	333	33,95	403	346
8,50	31,65	375	323	33,18	393	338	34,66	411	353	36,07	428	368
9,00	33,59	398	343	35,14	417	358	36,71	435	374	38,19	453	389
9,50	35,37	419	361	37,09	440	378	38,74	459	395	40,31	478	411
10,00	37,23	441	380	39,04	463	398	40,78	484	416	42,44	503	433
11,00	40,96	486	418	42,94	509	438	44,86	532	457	46,68	554	476
12,00	44,68	530	456	46,85	556	478	48,94	580	499	50,92	604	519
14,00	52,12	618	531	54,65	648	557	57,10	677	582	59,41	705	606
16,00	59,57	706	607	62,46	741	637	65,26	774	666	67,90	805	692
18,00	67,02	795	683	70,27	833	717	73,41	871	749	76,39	906	779
20,00	74,47	883	759	78,08	926	796	81,57	967	832	84,87	1007	865

The table applies to oil with a viscosity of 4,4 mm²/s (cSt) with density 830 kg/m³

2.7 Nozzle table

Pump pressure bar

Gph	14			15			16			17		
	kg/h	kW	Mcal/h	kg/h	kW	Mcal/h	kg/h	kW	Mcal/h	kg/h	kW	Mcal/h
2,75	12,11	144	123	12,53	149	128	12,95	154	132	13,35	158	136
3,00	13,21	157	135	13,67	162	139	14,13	168	144	14,56	173	148
3,50	15,42	183	157	15,95	189	163	16,49	196	168	16,99	201	173
4,00	17,62	209	180	18,23	216	186	18,84	223	192	19,42	230	198
4,50	19,82	235	202	20,51	243	209	21,20	251	216	21,84	259	223
5,00	22,03	261	225	22,79	270	232	23,55	279	240	24,27	288	247
5,50	24,23	287	247	25,07	297	256	25,91	307	264	26,70	317	272
6,00	26,43	313	270	27,49	326	280	28,27	335	288	29,13	345	297
6,50	28,63	340	292	29,63	351	302	30,62	363	312	31,55	374	322
7,00	30,84	366	314	31,91	378	325	32,98	391	336	33,98	403	347
7,50	33,04	392	337	34,19	405	349	35,33	419	360	36,41	432	371
8,00	35,25	418	359	36,47	433	372	37,69	447	384	38,80	460	396
8,50	37,45	444	382	38,74	459	395	40,04	475	408	41,26	489	421
9,00	39,65	470	404	41,02	486	418	42,40	503	432	43,69	518	446
9,50	41,85	496	427	43,30	514	442	44,75	531	456	46,11	547	470
10,00	44,06	523	449	45,58	541	465	47,11	559	480	47,11	559	480
11,00	48,46	575	494	50,14	595	511	51,82	615	528	53,40	633	545
12,00	52,87	627	539	54,70	648	558	56,53	670	576	58,25	691	594
14,00	62,68	732	629	63,81	757	651	65,95	778	669	67,96	806	693
16,00	70,49	836	719	72,93	865	744	75,38	894	769	77,67	921	792
18,00	79,30	940	809	82,05	973	837	84,80	1006	865	87,38	1036	891
20,00	88,11	1045	899	91,17	1081	930	94,22	1117	961	97,09	1151	990

The table applies to oil with a viscosity of 4,4 mm²/s (cSt) with density 830 kg/m³

3. INSTALLATION

3.1 Acceptance inspection

Ensure that everything is delivered and that there is no transport damage. If there is anything wrong with the delivery, please report it to the supplier. Any transport damage should be reported to the forwarding company..

3.2 Preparations for installation

Ensure that the size and capacity range of the burner are suitable for the boiler. Power data on the data plate refer to the minimum and maximum power of the burner.

3.3 Distribution of oil

To ensure satisfactory operation it is essential that the oil distribution system is correct.

Observe the following:

- See Pump instructions for choice of tube diameter, tube length and height difference.
- Fix the tubing with a minimum number of screw fittings.
- Fix the tubes so that the oil hoses are not subjected to tensile stress or sharp bending when swinging out the burner or removing it for service.
- Fit the oil filter 1½" so that the filter cartridge can easily be replaced.

3.4 Electrical connections

The main power switch must be turned off before beginning electrical installation. If the boiler has a 7-pin and a 4-pin Eurostecker connector these will often connect straight to the burner. If not, use the connectors supplied. A 5-pin connector supplies the burner motor with a separate 3-phase supply. See connection under the Electrical equipment heading.



If another electrical connection is used than the one recommended by Bentone, there might be a risk of material damage or personal injury.

3.5 Choice of nozzle

See under Technical Data: Recommended nozzle and table of nozzles.

3.6 Setting of the brake plate and air flow

Basic burner settings can be made before commissioning as shown in the diagram. See Basic settings. Note that these are just basic settings and must be correctly adjusted when the burner has been started. Flue gas analysis and soot measurement should be carried out at this time.

3.7 Burner installation

3.7.1 Hole pattern

Check that the hole pattern on the boiler matches the pattern on the burner flange.

Flame head	d_1	d_2	d_3
B55	(160)* 165	M12	(226)* 254-295
B65	(160)* 210	M12	(226)* 254-295

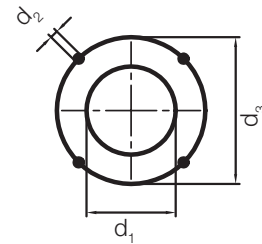

The hole pattern can be reduced if the burner pipe is fitted from the front and the heels in the flange are ground off.

3.8 Installing the burner

1. Separate the burner body and the flange.
2. Fit the flange and gasket on the boiler.
3. Insulate between the burner pipe and boiler door to reduce heat radiation.
4. Slide the burner body on to the guides.
5. Pull the brake plate off the oil pipe.
6. Fit the chosen nozzles (see Technical data).
7. Fit the brake plate and check the ignition electrodes (see Servicing the burner).
8. Slide the burner together and secure it with the nuts (E).

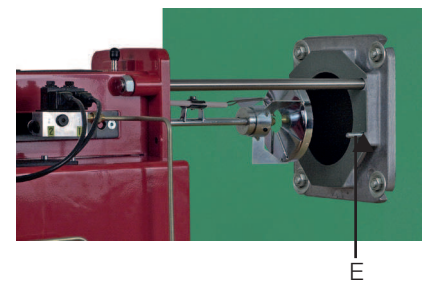
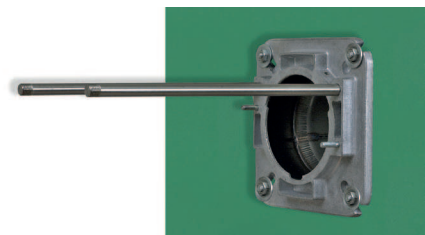

3.9 Oil lines

1. Check the size of the oil line (see Pump instructions)
2. An oil filter (1/2") must be fitted to the oil line. If an air trap is fitted then the oil filter should be fitted to the oil line before the air trap.
3. With a single pipe system the return plug must be removed (see Pump instructions).
4. When fitting oil hoses, check that the supply and return hoses are connected to the right couplings on the oil pump. The hoses must be positioned so that they are not subjected to tensile stress or sharp bending.
5. Bleed the oil system. The oil pump will be damaged if it is run dry.
6. The vacuum in the suction line should not exceed 0.3 bar during commissioning.



Return line Suction line

3.10 Electrical connections

1. Turn off the main power switch.
2. Connect the Eurostecker connectors (see Electrical equipment).
3. Check that the burner control switch (S1) is off.
4. Fit the Eurostecker connectors on the burner.
5. Turn on the main power switch.
6. Check the direction of rotation of the burner motor.



4. BASIC SETTINGS

4.1 Typical basic settings for B65-2H/B65-2 B65-2R/B65-3R

Choice of nozzle B65-2H/B65-2/B65-2R

Burner output	770 kW
Nozzle Stage 1	770 x 0,6 = 460 kW 460 / 11,86 = 38,8 kg/h
Nozzle Stage 2	770 x 0,4 = 310 kW 310 / 11,86 = 26,1 kg/h

According to the table of nozzles this gives the following nozzles.

Stage 1	8,50 Gph
Stage 2	6,00 Gph

Pump pressure : 14 bar

Basic settings B65-2H

Nozzle assembly	Stage 2 = 15
Air adjustment	Stage 1 = 25° Stage 2 = 65°

Each graduation on the scale corresponds to 10°

Basic settings B65-2

Power outputs and nozzle choice from example.

Nozzle assembly	Steg 2 = 15
Damper motor	Closed = 0° Blue cam Stage 1 = 25° Orange cam MV 2 = 50° Black cam Stage 2 = 65° Red cam

The black cam for Stage 2 (MV 2) must be placed between the cams for Stage 1 and Stage 2. The positions of MV 2 are determined by the boiler characteristics when switching between stages, but for a basic setting the black cam should be placed in the middle.

Basic settings B65-2R

Power outputs and nozzle choice from example

Nozzle assembly	Stage 1 = 0 Stage 2 = 15
Damper motor	Closed = 0° Blue cam Stage 1 = 25° Orange cam MV 2 = 50° Black cam Stage 2 = 65° Red cam

The black cam for Stage 2 (MV 2) must be placed between the cams for Stage 1 and Stage 2. The positions of MV 2 are determined by the boiler characteristics when switching between stages, but for a basic setting the black cam should be placed in the middle.

Choice of nozzle B65-3R

Burner output	880 kW
Nozzle	880 / 3 = 293 kW 293 / 11,86 = 24,7 kg/h

According to the table of nozzles this gives the following nozzles:

Stage 1	5,50 Gph
Stage 2	5,50 Gph
Stage 3	5,50 Gph

Basic settings B65-3R

Power outputs and nozzle choice from example

Nozzle assembly	Stage 1/2 = 5 Stage 3 = 20
Damper motor	Stage 1 = 10° Blue cam MV 2 = 30° Black cam Stage 2 = 44° Orange cam MV 3 = 60° Green cam Stage 3 = 80° Red cam

The cams for Stage 2 (MV 2) and Stage 3 (MV 3) must be placed between the cams for Stage 1 and Stage 2, and between Stage 2 and Stage 3, respectively. The positions of MV 2 and MV 3 are determined by the boiler characteristics when switching between stages, but for a basic setting the cams (MV2 and MV3) should be placed in the middle.

4.2 Set values for nozzle assembly B55

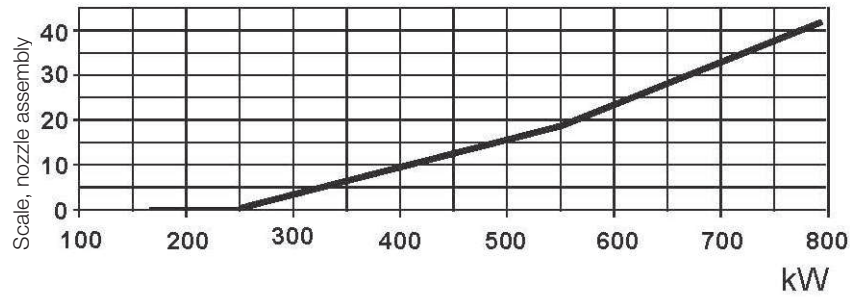

4.3 Set values for nozzle assembly B65

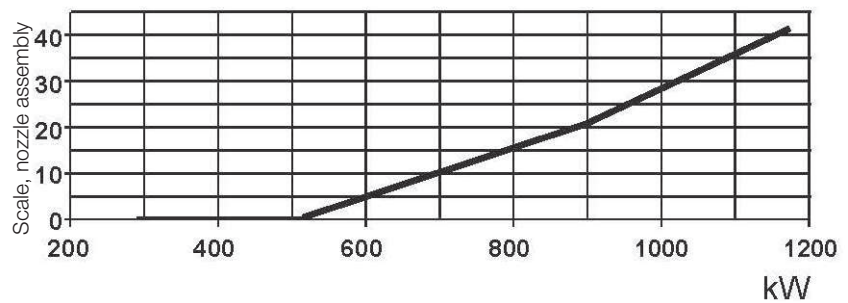

4.4 Set values for air damper B55

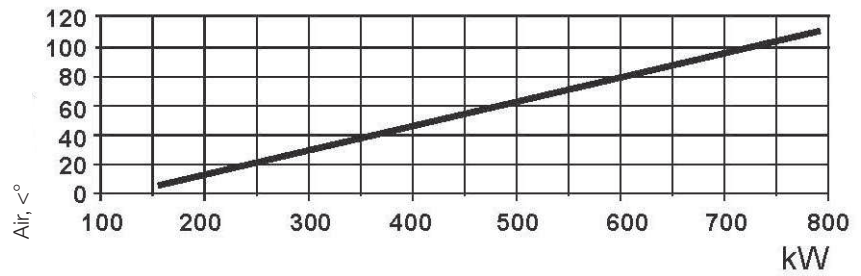

4.5 Set values for air damper B65

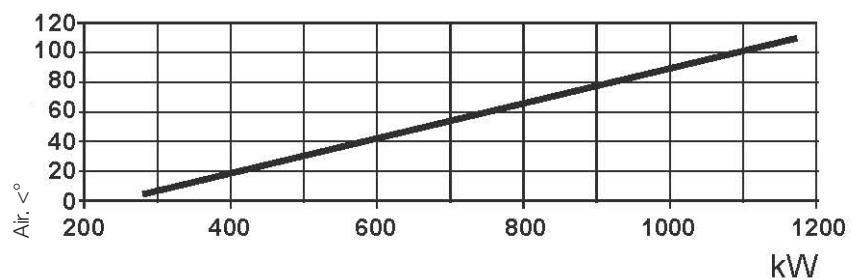

4.6 Nozzle assembly regulation – fixed brake plate

Nozzle assembly regulation is used to achieve the most favourable pressure drop possible across the brake plate.

Nozzle assembly regulation should be adjusted for Stage 2 output

Adjustment

Adjust to the desired position on the scale (A) using the set screw (B) (turning anti-clockwise reduces the pressure drop and moves the brake plate outwards).

If pulsation occurs, the pressure drop across the brake plate can be altered until pulsation stops.

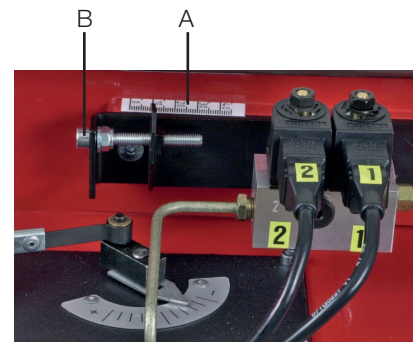

4.7 Nozzle assembly regulation – adjustable brake plate

Nozzle assembly regulation is used to achieve the most favourable pressure drop possible across the brake plate for each output stage.

Two nozzles

Nozzle assembly regulation adjusts the position of the brake plate between Stage 1 and Stage 2 by means of a hydraulic piston.

Three nozzles

Nozzle assembly regulation adjusts the position of the brake plate between Stage 2 and Stage 3 by means of a hydraulic piston.

Low load

Undo the locking nut.

Adjust to the desired position on the scale (A) by sliding the plate to the desired position. Tighten the locking nut (C).

High load

Adjust to the desired position on the scale (A) using the set screw (D) (turning anti-clockwise reduces the pressure drop and moves the brake plate outwards). If pulsation occurs, the pressure drop across the brake plate can be altered until pulsation stops.

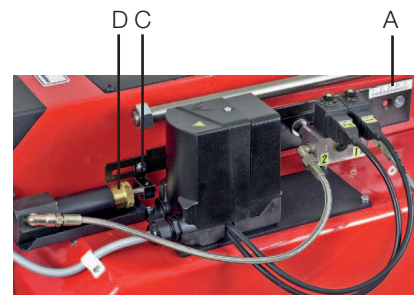

4.8 Hydraulic air adjustment

Stage 1

Set the control switch (S2) to low load (I). Undo the screw (E), turn the damper to the desired position and retighten the screw (E).

Stage 2

Set the control switch (S2) to high load (I). Use the adjuster pin to screw the sleeve (F) in (to reduce) or out (to increase). The position of the damper can be read from the damper scale (G). Carry out flue gas analysis to check the air settings

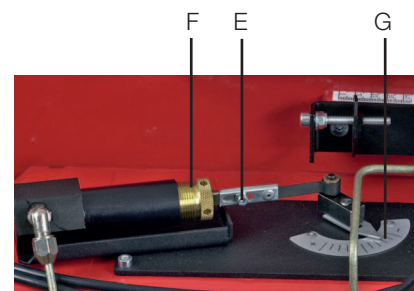

4.9 Damper motor 2-Stage

The damper motor rotates the damper between three preset positions. These positions are controlled at the motor by micro-switches, the switching positions of which are set using the coloured cams. There is also a black cam, which controls the activation of solenoid valve 2.

If the air flow requires adjustment: Remove the cover from the damper motor and change the positions of the cams by turning them with the aid of the tool supplied. To deactivate a cam while you are turning it we recommend that you switch to a different stage and then switch back after adjustment is complete in order to check the result.

Stage 1

Adjust the operating switch to Stage 2 (II).

- * Reduce the air volume: Turn orange cam towards 0°.
- * Increase the air volume: Turn orange cam towards 90°.

Adjust the operating switch back to low capacity and check.

Stage 2

Adjust the operating switch to Stage 1 (I).

- * Reduce the air volume: Turn red cam towards 0°.
- * Increase the air volume: Turn red cam towards 90°

If the red cam is moved, change the black cam as much. Adjust the operating switch back to Stage 2 and ensure that the correct air volume has been obtained.

Closed

The blue cam is the limit position for fully closed damper and it is normally not necessary to change it.

Releasing

The damper motor can be released using the white release button. This feature simplifies replacement of the damper motor.

To release	Press down the shaft and slide it outwards until it disengages from the milled slot.
To engage.	Slide the shaft inwards and release. Adjust the position of the motor so that the cogs mesh with each other.

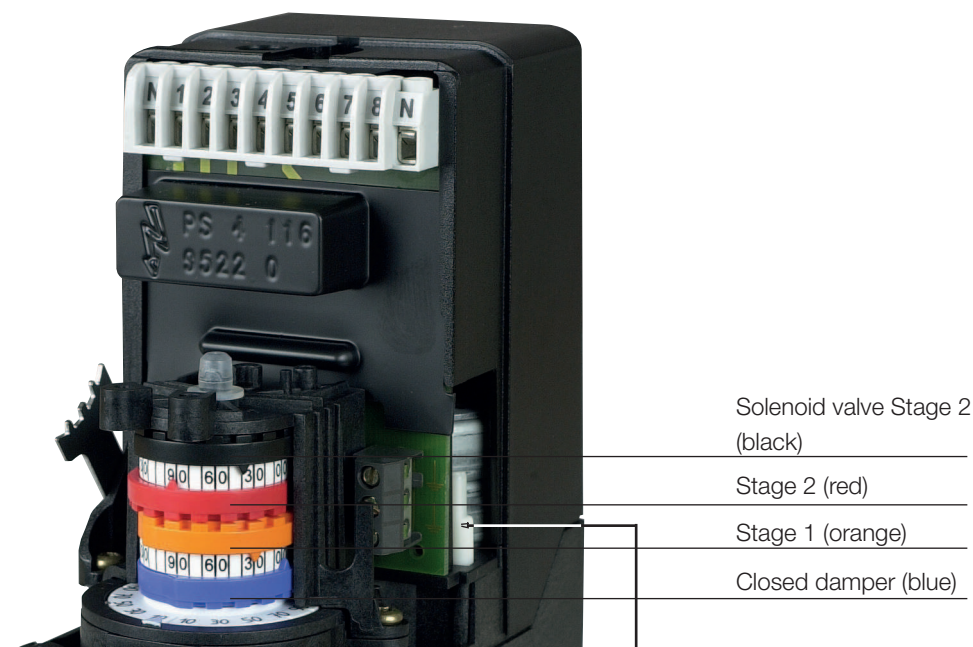

Releasing button N.B.
The upper position is the standard position

4.10 Damper motor 3-Stage

The damper motor rotates the damper between three preset positions. These positions are controlled at the motor by micro-switches, the switching positions of which are set using the coloured cams. There is also a black cam, which controls the activation of solenoid valve 2 and a green one which controls the activation of solenoid valve 3.

If the air flow requires adjustment: Remove the cover from the damper motor and change the positions of the cams by turning them with the aid of the tool supplied. To deactivate a cam while you are turning it we recommend that you switch to a different stage and then switch back after adjustment is complete in order to check the result.

Stage 1

Adjust the operating switch to Stage 2 (II).

- * Reduce the air volume: Turn blue cam towards 0°.

- * Increase the air volume: Turn blue cam towards 90°.

Adjust the operating switch back to Stage 1 and check.

Stage 2

Adjust the operating switch to Stage 1 (I).

- * Reduce the air volume: Turn orange cam towards 0°.
- * Increase the air volume: Turn orange cam towards 90°.

If the orange cam is moved, change the black cam as much. Adjust the operating switch back to Stage 2 and ensure that the correct air volume has been obtained.

Stage 3

Adjust the operating switch to Stage 2 (II).

- * Reduce the air volume: Turn red cam towards 0°.
- * Increase the air volume: Turn red cam towards 90°.

If the red cam is moved, change the green cam as much. Adjust the

operating switch to Stage 3 (III) and ensure that the correct air volume has been obtained.

Releasing

The damper motor can be released using the white release button. This feature simplifies replacement of the damper motor.

To release Press down the shaft and slide it outwards until it disengages from the milled slot.

To engage Slide the shaft inwards and release. Adjust the position of the motor so that the cogs mesh with each other..

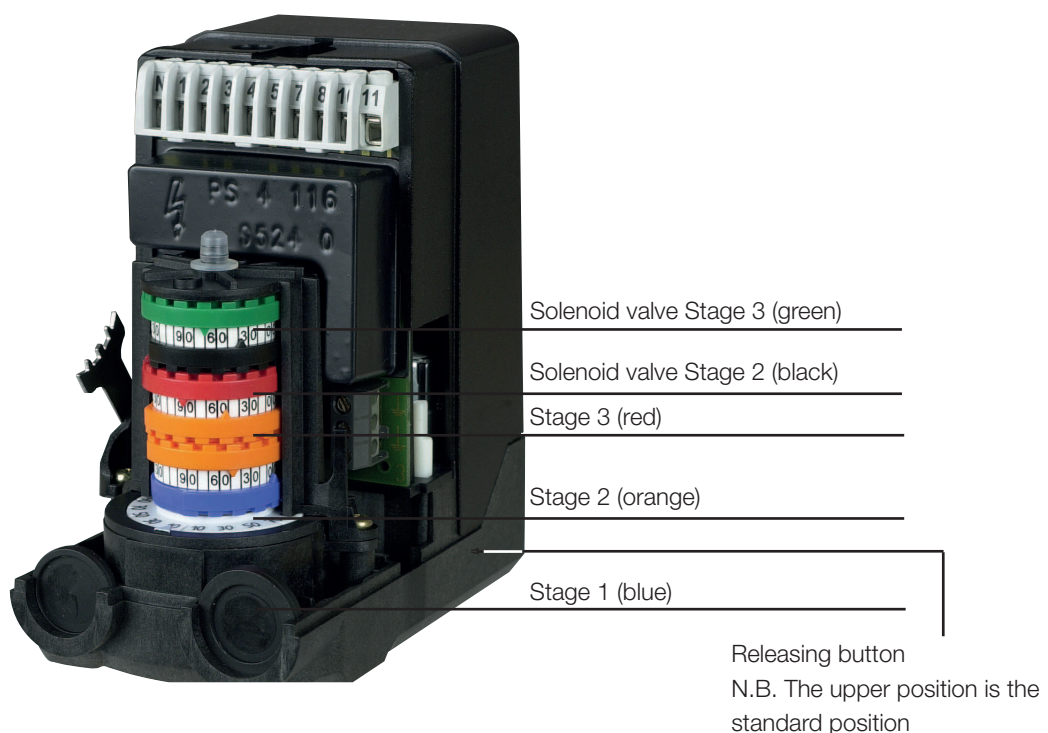

5. MAINTENANCE

5.1 Servicing the burner device

Removal and fitting

1. Turn off the main power switch and disconnect the Eurostecker connectors from the burner.
2. Undo the nuts (E) and pull out the burner body on its guides.
3. Undo and remove the brake plate from the oil pipe.
4. Unscrew the nozzles.
5. Fit the nozzles.
6. Fit the brake plate (see Adjusting the brake plate).
7. Check the ignition electrodes (see Adjusting ignition electrodes). Replace if necessary.
8. Slide the burner together and secure it with the nuts (E).
9. Connect the Eurostecker connectors and turn on the main power switch.
10. Check combustion*.

Note!:

- * After servicing/replacing components that affect combustion, a flue gas analysis and soot measurement must be carried out on the installation.

NOTE! If nozzles are dirty always replace them with new ones. Do not clean them.

On boilers with a hinged door, the door can be opened and the burner pipe can be removed from the flange and pulled forwards.

With burners that have an extended burner tube, the burner body must be lifted off the guides, or the oil pipe must be disconnected from the solenoid valves to be removed for servicing..

5.2 Adjusting the ignition electrodes and brake plate

Adjustment dimensions for ignition electrodes.

Burner, type	a	b	c	d	e
B55 -2	2,5-3,0	2,0	6,5-7,0	2,0	6,0-7,0
B55-3	2,5-3,0	0,0	6,5-7,0	2,0	6,0-7,0
B65-2	2,5-3,0	2,0	6,5-7,0	2,0	10,0-12,0
B65-3	2,5-3,0	0,0	6,5-7,0	2,0	10,0-12,0

NOTE! It is important that the spark does not strike the brake plate or nozzle. B55

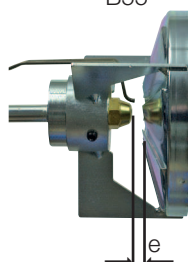

B65

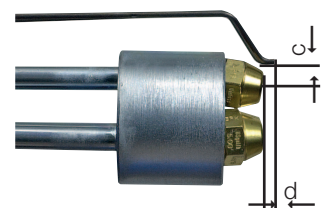
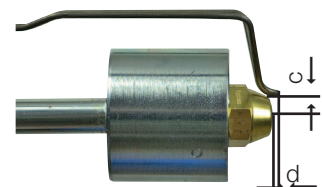
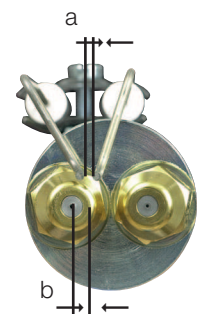
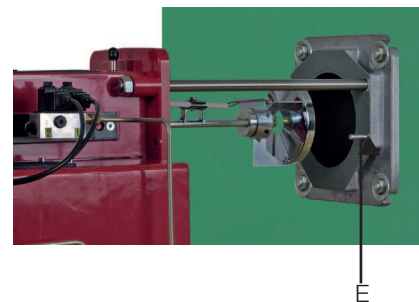
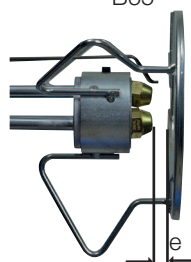

5.3 Servicing the air damper

Removal and fitting

1. Turn off the main power switch and disconnect the Eurostecker connectors from the burner.
2. Undo the nuts (E) and pull out the burner body on its guides.
3. Remove the intake grille from the air intake.
4. Release the damper motor.
5. Clean the air damper (F) and the intake. Lubricate the damper shaft if applicable.
6. Re-engage the damper motor.
7. Fit the intake grille over the air intake.
8. Slide the burner together and secure it with the nuts (E).
9. Connect the Eurostecker connectors and turn on the main power switch.
10. Check combustion*.

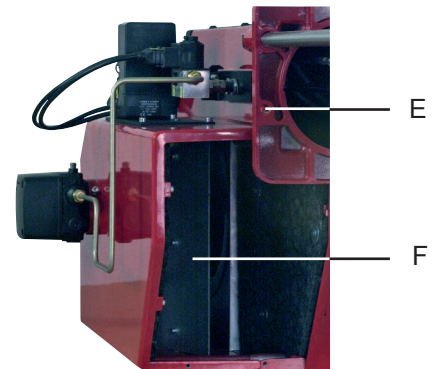

5.4 Replacing the damper motor

Removal and fitting

1. Turn off the main power switch and disconnect the Eurostecker connectors from the burner.
2. Note the positions of the cables and then disconnect the cables from the damper motor.
3. Release the damper motor and lock it at 30°.
4. Undo the screws (G) that secure the mounting plate for the damper motor.
5. Raise it carefully so that the air damper stays in the air intake.
6. Disconnect the (H) link arm from the motor shaft.
7. Separate the damper motor from the mounting plate (I).
8. Refit the damper motor on the mounting plate.
9. Connect the link arm to the damper motor shaft. It is important that the screw is at right angles to the plane of the shaft.
10. Release the damper motor and lock it at 30°.
11. Fit the mounting plate by guiding the link arm into the attachment point on the air damper and the air damper shaft into the mounting plate (make sure that the bushings are fitted between the mounting plate and damper shaft).
12. Release the damper motor and check that the damper moves freely. Close the damper and zero the graduated scale on the damper motor.
13. Make the electrical connections to the damper motor.
14. Reset the damper motor cams.
15. Connect the Eurostecker connectors and turn on the main power switch.
16. Check combustion*.

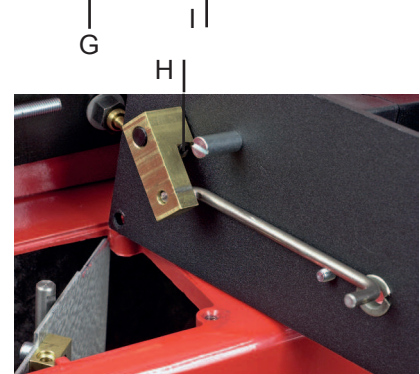
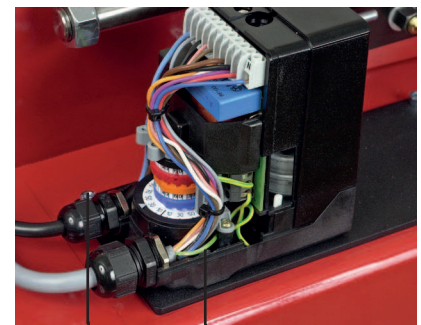

5.5 Replacing the oil pump B55/B65

Removal and fitting

1. Turn off the main power switch and disconnect the Eurostecker connectors from the burner.
2. Disconnect the oil hoses from the pump.
3. Undo the screws (J) and pull out the oil pump.
4. Measure the distance between the pump mounting and the pump coupling (K).
5. Transfer the pump coupling to the new pump and adjust to give the same spacing between the pump and pump coupling as before (K).
6. Fit the oil pump on the burner and tighten the screws (J). (It is important that splines on the pump shaft align correctly with the pump coupling.)
7. Fit the oil hoses.
8. Connect the Eurostecker connectors and turn on the main power switch.
9. Bleed the pump, start the burner and adjust to the correct oil pressure.
10. Check combustion.*

Note:

- * After servicing/replacing components that affect combustion, a flue gas analysis and soot measurement must be carried out on the installation

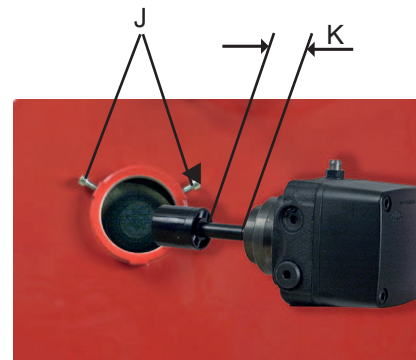

6. INSTRUCTIONS PUMP

6.1 TYPE 95 & 125

Technical data	RSA 95	RSA 125
Viscosity range:	1,3-18,0 mm ² /s	
Pressure range at viscosity 1,3-1,8:	5,5-12,0 bar	
Pressure range at viscosity 1,8-18,0:	2,5-21,0 bar	
Oil temperature:	-10 till +70°C	
Nozzle capacity at viscosity 4,3:	150-190 l/h	215-260 l/h
Gearwheel capacity:	225 l/h	294 l/h
Max pressure on suction- and return side:	4 bar	

6.2 Components

1. Pressure gauge port G 1/8"
2. Nozzle port G 1/4"
3. Suction line G 1/4"
4. Suction line G 1/4"
5. Return line G 1/4"
6. Return line G 1/4"
7. By-pass plug
8. Pressure adjustment, 4 mm Allen key

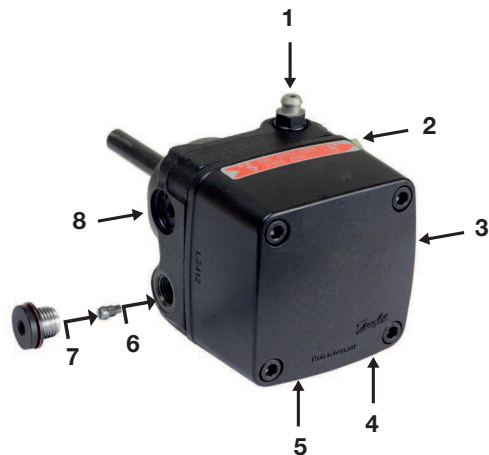

6.3 Mounting/dismounting by-pass plug

In a 2-pipe-system excess oil is led back direct to the oil tank. In a 1-pipe-system the by-pass plug must be removed so that there is a free passage back to the suction side through the return line with the return port closed. (Pos.7).

6.4 Purging

On 1-pipe systems it is necessary to purge the pump. On 2-pipe systems purging is automatic through the return line.

6.5 Replacing the filter

Replace the oil filter on the oil pump as follows.

- Close the oil valves.
- Unscrew the cover (4 x 5 mm Allen screws).
- Replace the oil filter.
- Replace the cover gasket.
- Refit the cover.
- Open the oil valves.



6.6 Function Danfoss RSA 95 - 125

When the pump is started oil is drawn through the suction port "S" via filter "H" to the suction side of the gearwheel set "C". From here the gearwheel set pumps the oil to the pressure side and at the same time the oil becomes pressurized. The oil is led to cut-off and regulating valve "V" which opens when the set pressure is reached.

The pressure is controlled and kept constant by regulating valve "V". At the same time the gearwheel set "C" distributes the oil through nozzle port "P" and pump return side "R" via the shaft seal "F".

The quantity of oil supplied to nozzle port "P" is determined by the pressure set on regulating valve "V" and the nozzle/resistance in the nozzle line.

In 2-pipe-systems excess oil is led back to the oil tank. In 1-pipe-systems the by-pass plug "A" must be removed to give free flow back to the suction side via return line "G" with return port "R" closed.

When the pump is stopped, the pump output drops and produces a drop in the oil pressure. The spring in the regulating valve presses the regulating piston forward until it seals in port "P". This cuts off the oil flow to the nozzle and ensures that the nozzle line is effectively shut off.

If the pump is overloaded, i.e. more oil is demanded than the gearwheel is able to pump under the given conditions, the oil pressure falls below the set value because the piston of the regulating valve moves towards its closed position and partially or wholly cuts off the return oil via port "O".

This can be remedied by

- reducing the pump pressure
- reducing the capacity, i.e. smaller nozzle or greater resistance
- changing to a pump with higher capacity

Schematic diagram

1. Nozzle Stage 1
2. Nozzle Stage 2
3. Nozzle Stage 3
4. Solenoid valve Stage 1 (Y1)
5. Solenoid valve Stage 2 (Y2)
6. Solenoid valve Stage 3 (Y3)
7. Safety valve for nozzle (Y1S)
Only for capacities over 100 kg/h or on special request by customer
8. Hydraulic control device
Only on burners with hydraulic air control or nozzle assembly optimisation.
9. Oil pump

Items 3 and 6 are not fitted to two-stage burners. Item 8 is connected after solenoid valve nozzle 2 (Y2).

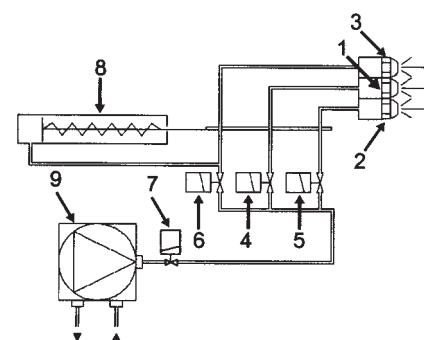
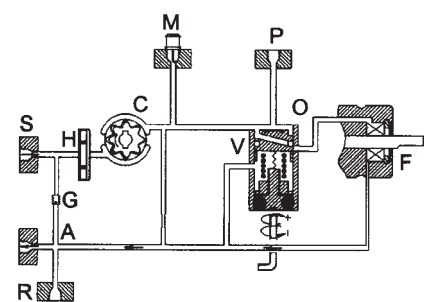

6.7 Suction line tables

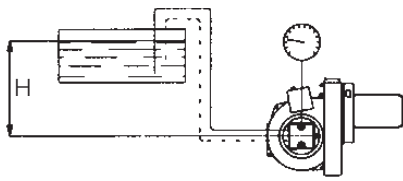

1-pipe system

Höjd	Pipe diameter		
H	ø12mm	ø15mm	ø20mm
m	m	m	m

With an overlying tank a 1-pipe-system is not recommended.

Two-pipe system			
Height	Pipe diameter		
H	ø12mm	ø15mm	ø20mm
m	m	m	m
4,0	81	100	100
3,5	76	100	100
3,0	71	100	100
2,5	66	100	100
2,0	61	100	100
1,5	56	100	100
1,0	51	100	100
0,5	46	100	100

The suction line tables consist of theoretically calculated values where the pipe dimensions and oil velocity have been matched so that turbulences will not occur. Such turbulences will result in increased pressure losses and in acoustic noise in the pipe system.

In addition to drawn copper piping a pipe system usually comprises 4 elbows, a non-return valve, a cut-off valve and an external oil filter. The sum of these individual resistances is so insignificant that they can be disregarded.

The tables do not include any lengths exceeding 100 m as experience shows that longer lengths are not needed. The tables apply to a standard fuel oil of normal commercial quality according to current standards. On commissioning with an empty tube system the oil pump should not be run without oil for more than 5 min. (a condition is that the pump is being lubricated during operation).

The tables state the total suction line length in metres at a viscosity of 6,0 mm²/s.

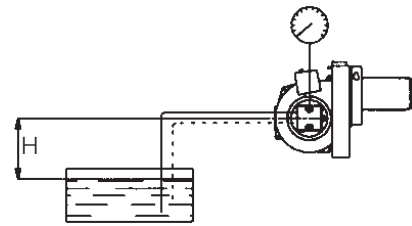

1-pipe system

Height	Pipe diameter		
H	ø12mm	ø15mm	ø20mm
m	m	m	m

With an overlying tank a 1-pipe-system is not recommended.

Two-pipe system			
Height	Pipe diameter		
H	ø12mm	ø15mm	ø20mm
m	m	m	m
0,0	41	100	100
-0,5	36	89	100
-1,0	31	77	100
-1,5	26	65	100
-2,0	22	53	100
-2,5	17	41	100
-3,0	12	29	91
-3,5	7	17	53
-4,0	2	5	15

7. ELECTRIC EQUIPMENT

7.1 Wiring diagram LMO24.255...(B55-2H/B65-2H)

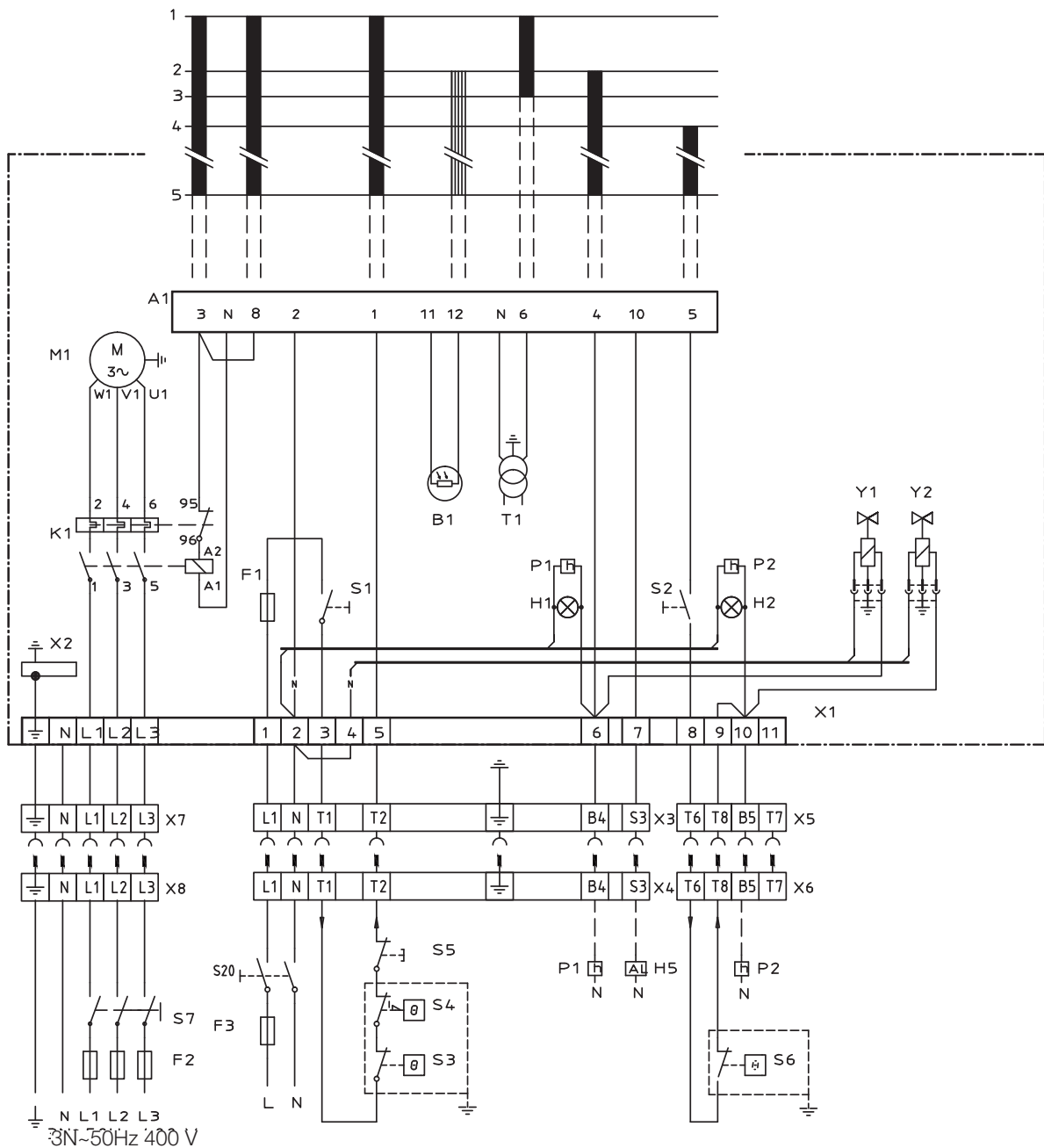

Wiring diagram LMO24.255...
(B55-2H,R/B65-2H,R)

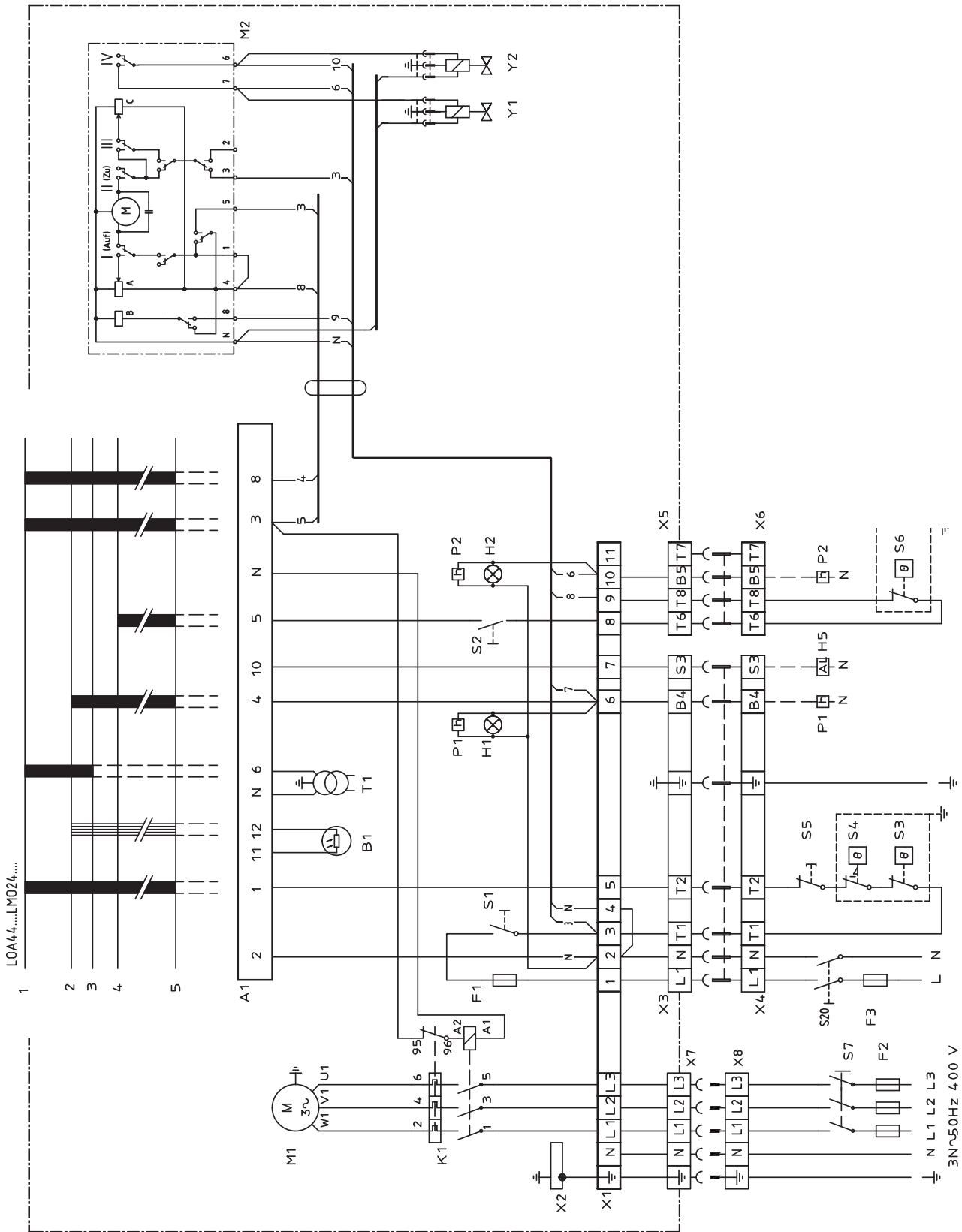

171 435 45 2016-06-30

Wiring diagram LMO24.255...
(B55-2H/B65-2H)

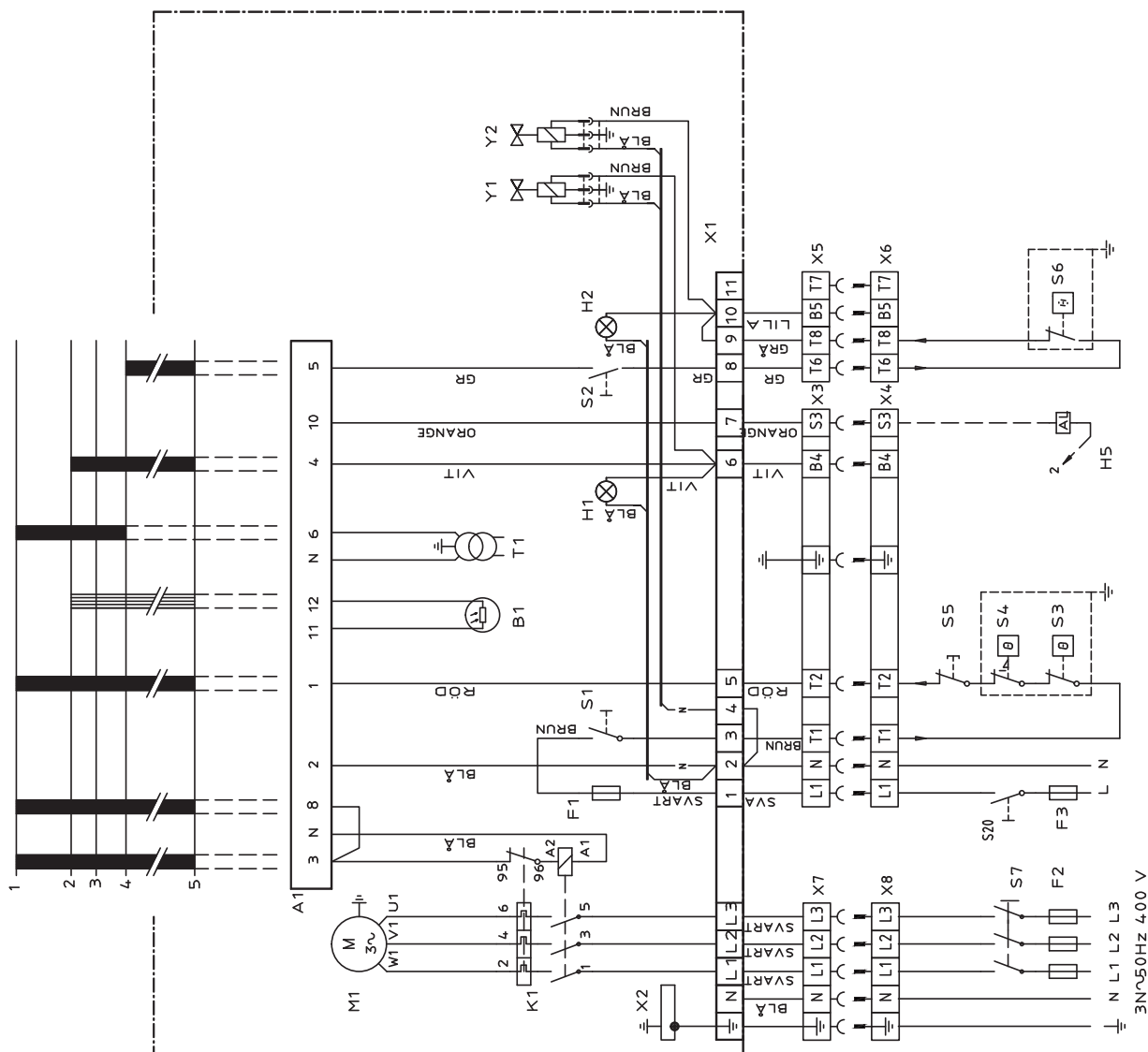

171 435 45 2016-06-30

List of components LMO24.255... (B55-2H,R/B65-2H,R)

A1	Oil burner control	S5	Micro switch for hinged door
B1	Photoresistor	S6	Control thermostat, high/low
F1	Operating fuse	S7	Main switch 3-fas
F2	Fuse	S20	Main switch 1-fas
F3	Fuse	T1	Ignition transformer
H1	Lamp, low capacity	X1	Connection terminal board
H2	Lamp, high capacity	X2	Earth terminal
H5	Alarm signal 230V	X3	Plug-in contact "Euro" burner
K1	Thermal overload protection	X4	Plug-in contact "Euro", boiler
M1	Burner motor	X5	Plug-in contact "Euro" high/low burner
M2	Damper motor SQN75.244A21B	X6	Plug-in contact "Euro", high/low boiler
P1	Time meter, low capacity (optional)	X7	Plug-in contact "Euro" 3-phase, burner
P2	Time meter, high capacity (optional)	X8	Plug-in contact "Euro", 3-phase, boiler
S1	Operating switch	Y1	Solenoid valve 1
S2	Operating switch, high/low capacity	Y2	Solenoid valve 2
S3	Operation thermostat		
S4	Temperature limiter		

If S6 is missing connection between T6 and T8. Mains connection and fuse in accordance with local regulations.

max loading K1

Connection A1,A2 / 95, 96 / 97, 98 Max 0,2A/15W

ELECTRIC EQUIPMENT

Function

1. Switch on operating switch and twin thermostat

The burner motor starts, an ignition spark is formed, the prepurge goes on till the prepurge period expires and the solenoid valve 1 opens (2).

2. Solenoid valve 1 opens

Oil mist is formed and ignited. The photocell indicates a flame.

3. The safety time expires

- a. If no flame is established before this time limit the control cuts out.
- b. If for some reasons the flame disappears after this time limit, the burner will make an attempt to re-start.

4. Full load thermostat ON

The ignition spark goes out after flame indication (See Technical data oil burner control). The burner is in operating position and can now change between high and low capacity.

4-5. Operating position

If the burner operation is interrupted by means of the main switch or the thermostat, a new start takes place when the conditions in accordance with point 1 are fulfilled.

The oil burner control cuts out

A red lamp in the control is lit. Press the reset button and the burner re-starts.

Technical data LMO24.255...

	LMO24
Pre-ignition time:	25 s
Pre-purge time:	25 s
Post-ignition time:	< 1 s
Ambient temperature:	från - 5 till + 60°C
Min. current with flame established:	45 µ A
Max. photo current at start:	5,5 µ A

Control of photo current

Current through photo unit is measured with a d.c. ammeter (a moving oil instrument connected in series with the photo unit).

7.2 Wiring diagram LAL 1... (B55-2/B55-2R/B65-2/B65-2R)

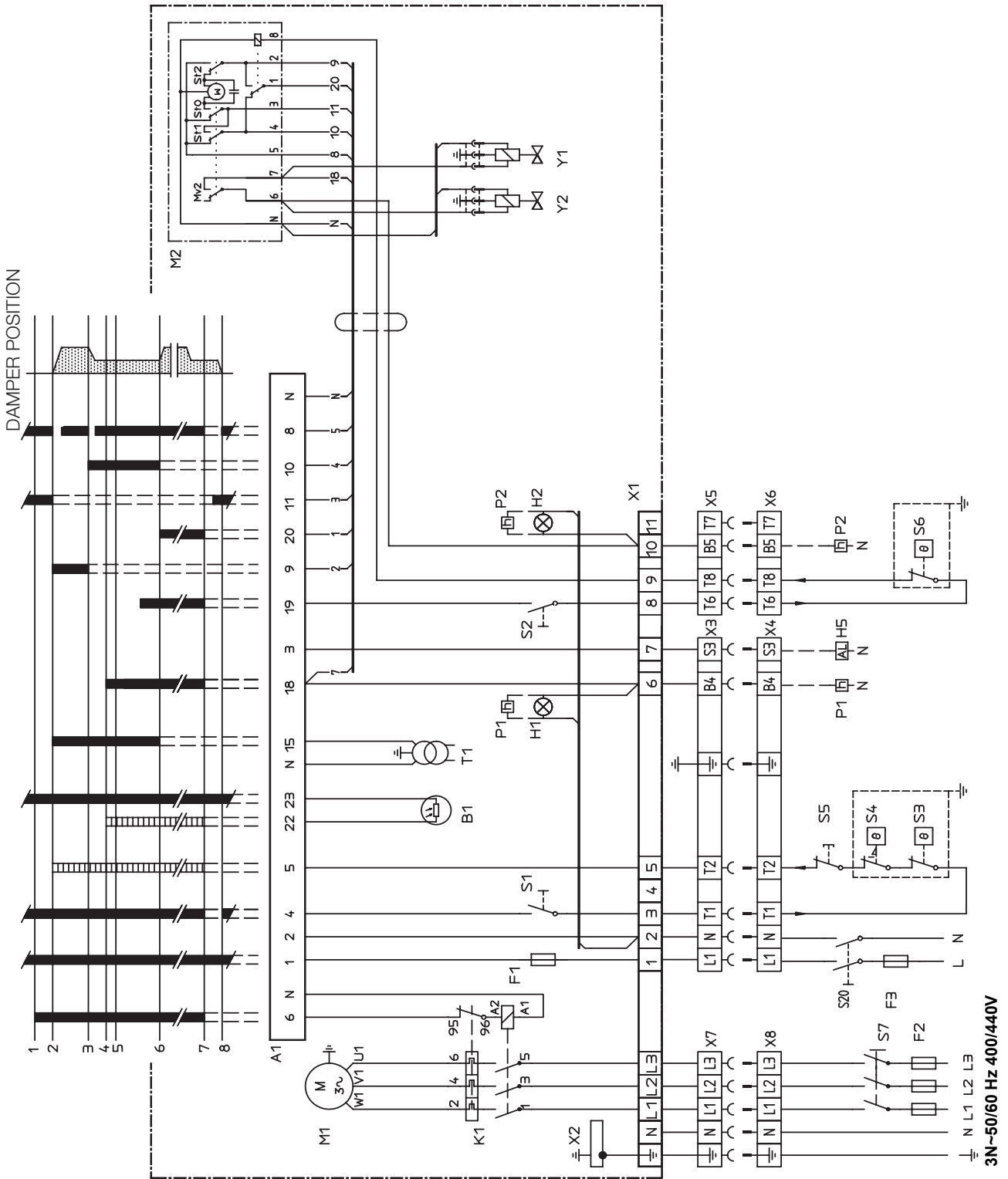

7.2.1 List of components LAL 1... (B55-2/B55-2R/B65-2/B65-2R)

A1	Oil burner control	S5	Micro switch for hinged door
B1	Photoresistor	S6	Control thermostat, high/low capacity
F1	Operating fuse	S7	Main switch 3-fas
F2	Fuse	S20	Main switch 1-fas
F3	Fuse	T1	Ignition transformer
H1	Lamp, low capacity	X1	Connection terminal board
H2	Lamp, high capacity	X2	Earth terminal
H5	Alarm signal 230V	X3	Plug-in contact "Euro", burner
K1	Thermal overload protection	X4	Plug-in contact "Euro", boiler
M1	Burner motor	X5	Plug-in contact "Euro", high/low burner
M2	Damper motor L&S SQN75.294A21B	X6	Plug-in contact "Euro" high/low boiler
P1	Time meter, low capacity (optional)	X7	Plug-in contact "Euro" 3-phase, burner
P2	Time meter, high capacity (optional)	X8	Plug-in contact "Euro" 3-phase, boiler
S1	Operating switch	Y1	Solenoid valve 1
S2	Operating switch, high/low capacity	Y2	Solenoid valve 2
S3	Operation thermostat		
S4	Temperature limiter		

If S6 is missing connection between T6 and T8.

Mains connection and fuse in accordance with local regulations

max loading K1

Connection A1,A2 / 95, 96 / 97, 98 Max 0,2A/15W

7.2.2 Function LAL 1...

1. Operating switch ON, twin thermostat ON Air damper closed

The burner motor starts.

2. Ignition spark is formed

Ignition spark is formed. Air damper motor opens the damper to full load position.

3. Air damper motor closes

The air damper motor closes to low load position.

4. Solenoid valve opens

The oil mist is ignited. The photoresistor indicates a flame.

5. The safety time expires

- a. If there is no flame established **before** this time limit the burner control locks out.
- b. If the flame for some reason disappears **after** this time limit the burner control also locks out. If a repetition of the start-up sequence is desired, the wire link marked "Repetition" on the side of the base plate of the control must be removed.

6. Full load thermostat ON

The burner is in operating position. It can now change over to full load and then it alternates between full load and low load.

7. Stop

The burner operation is interrupted by means of the operating switch or if the thermostat switches off. The air damper closes completely and the oil burner control continues to position 8 for a new start.

8. State of rest

The burner is waiting for a new start.

The control locks out

A red lamp in the control is lit. Move the transparent cover aside and restart the burner by pressing the reset button.

Note! In the window of the control symbols appear showing in which position the control locks out, see the adjoining explanation.

7.3 Wiring diagram LAL 1... (B55-3/B65-3)

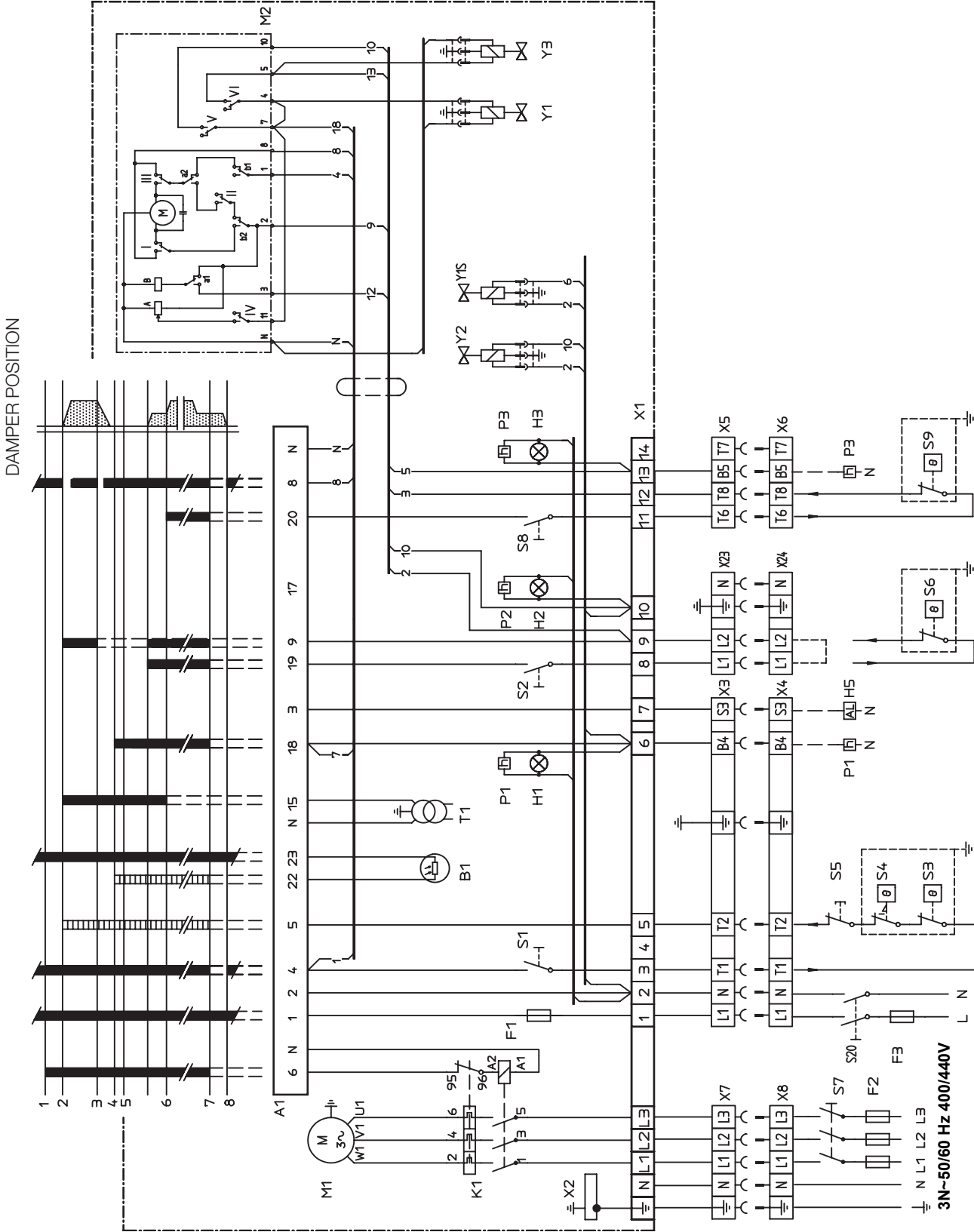

7.4 Wiring diagram LAL 1... (B55-3/B65-3 med regulator R316T)

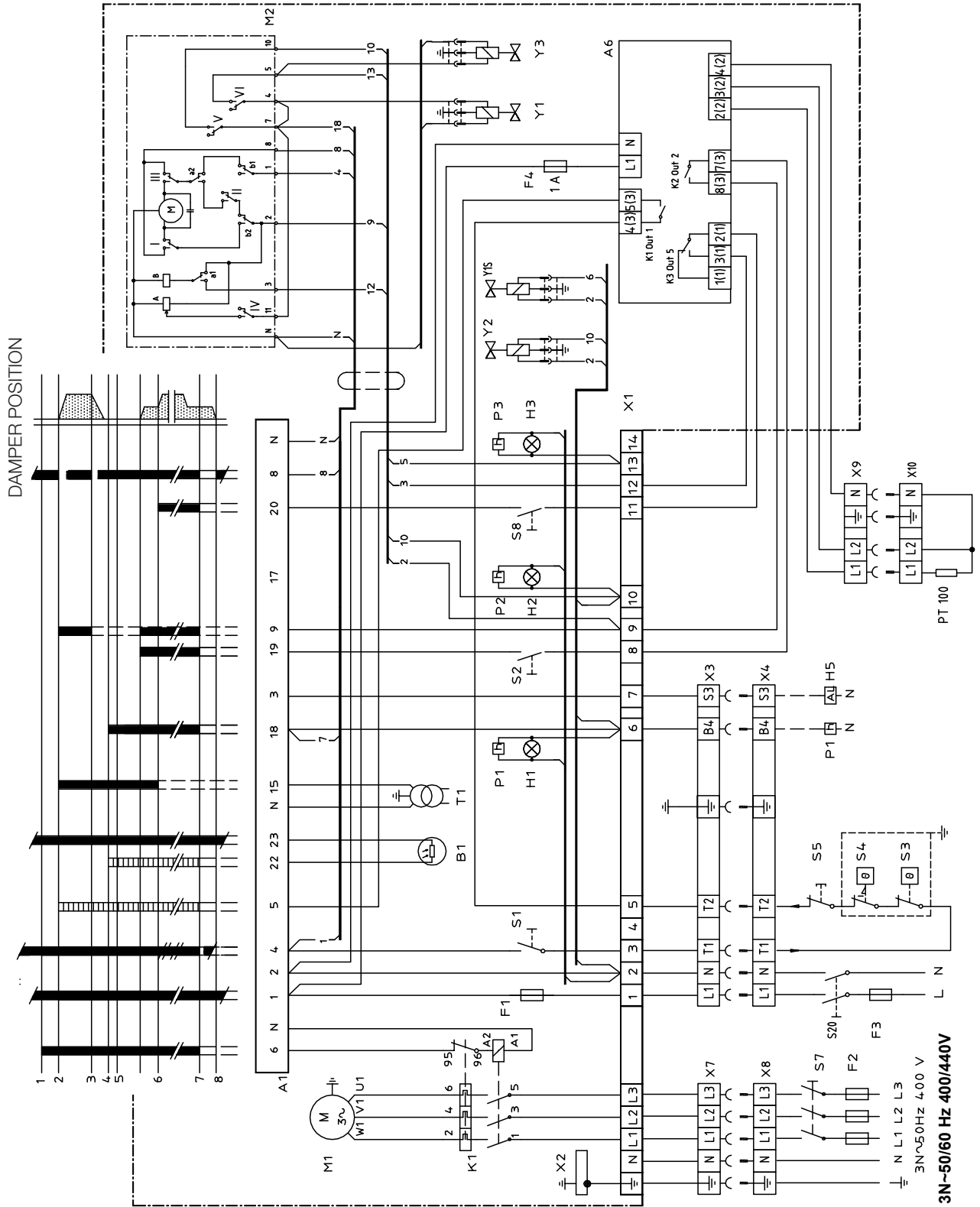

7.4.1 List of components LAL 1... (B55-3/B65-3 och B55-3/B65-3)

A1	Oil burner control	S8	Operating switch, Stage 3
A6	Regulator R316T	S9	Control thermostat, Stage 3
B1	Photoresistor	S20	Main switch 1-fas
F1	Operating fuse	T1	Ignition transformer
F2	Fuse	X1	Connection terminal board
F3	Fuse	X2	Earth terminal
F4	Fuse 1A	X3	Plug-in contact "Euro", burner
H1	Lamp, low capacity	X4	Plug-in contact "Euro", boiler
H2	Lamp, high capacity	X5	Plug-in contact "Euro", high/low burner
H3	Lamp, Stage 3	X6	Plug-in contact "Euro" high/low boiler
H5	Alarm signal 230V	X7	Plug-in contact "Euro" 3-phase, burner
K1	Thermal overload protection	X8	Plug-in contact "Euro" 3-phase, boiler
M1	Burner motor	X9	Plug-in contact regulator, burner
M2	Damper motor L&S SQN75.294A21B	X10	Plug-in contact regulator, PT 100-resistance thermometer
P1	Time meter, Stage 1	X23	Plug-in contact "Euro", Stage 2 burner
P2	Time meter, Stage 2	X24	Plug-in contact "Euro", Stage 2 boiler
P3	Time meter, Stage 3	Y1	Solenoid valve 1
S1	Operating switch	Y2	Solenoid valve 2
S2	Operating switch, high/low capacity	Y3	Solenoid valve 3
S3	Operation thermostat	Y1S	Safety solenoid valve
S4	Temperature limiter		(Standard on burners with an output ≥ 100 kg/h)
S5	Micro switch for hinged door		(Option on burners with an output < 100 kg/h)
S6	Control thermostat, high/low capacity		
S7	Main switch 3-fas		

If S6 is missing connection between L1 and L2.

If S9 is missing connection between T6 and T8.

Mains connection and fuse in accordance with local regulations

max loading K1

Connection A1,A2 / 95, 96 / 97, 98 Max 0,2A/15W

7.4.2 Function LAL 1...

1. Operating switch ON, twin thermostat ON Air damper closed

The burner motor starts.

2. Ignition spark is formed

Ignition spark is formed. Air damper motor opens the damper to stage 3..

3. Air damper motor closes

The air damper motor closes to stage 1..

4. Solenoid valve 1 opens

The oil mist is ignited. The photoresistor indicates a flame..

5. The safety time expires

- a. If there is no flame established **before** this time limit the burner control locks out.
- b. If the flame for some reason disappears **after** this time limit the burner control also locks out. If a repetition of the start-up sequence is desired, the wire link marked "Repetition" on the side of the base plate of the control must be removed.

6. Thermostat and switch Stage 2 ON

The burner can now change over to stage 2..

7. Thermostat and switch Stage 3 ON

The burner can now change over to stage 3..

8-9. Operating position

The burner can now change between stage 1, 2 and 3. The burner operation is interrupted by means of the operating switch or the thermostat.

The control locks out

A red lamp in the control is lit. Move the transparent cover aside and restart the burner by pressing the reset button.

 In the window of the control symbols appear showing in which position the control locks out , see the adjoining explanation.

7.4.3 Control programme under fault conditions and lock-out indication LAL 1...

In the event of fault conditions the sequence switch stops and simultaneously the lock-out indicator. The symbol appearing above the reading mark indicates kind of fault:

- ◀ **No start,**
because e.g., the CLOSE signal has not been supplied to terminal 8 by the limit switch, or a contact has not been closed between terminals 4 and 5.
 - ▲ **Shut-down of start-up sequence,**
because the OPEN signal has not been supplied to terminal 8 by the limit switch. Terminals 6, 7 and 15 remain under voltage until the fault is corrected.
 - **Lock-out**
due to a fault in the super-vision circuit.
 - ▼ **Shut-down of start-up sequence,**
because the position signal for the low-flame position has not been supplied to terminal 8 by the auxiliary switch. Terminals 6, 7 and 15 remain under voltage until the fault is corrected.
 - 1 **Lock-out,**
because no flame signal has been received on completion of the safety time.
 - | **Lock-out,**
because the flame signal has been lost during burner operation or air pressure failure has occurred.
 - ◀ **Lock-out on completion or after completion of control programme sequence due** to extraneous light (e.g. flame not extinguished, leaking fuel valves) or due to a faulty flame signal (e.g. fault in flame supervision circuit or similar).
- a - b Start-up sequence**
- b - b' „idle steps“**
up to the self shutdown of the sequence switch
- b (b') - a Post-purge sequence**

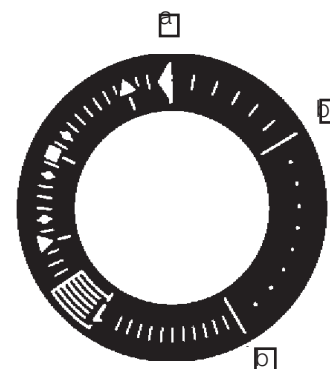

7.4.4 Technical data LAL 1...

Pre-ignition time:	from start
Pre-purge time with full air volume:	22 s
Safety time:	5 s
Post-ignition time:	15 s
Interval between Mv1 and Mv2:	7,5 s
Reset after lock-out:	Immediately
Time of re-start:	47 s
Ambient temperature:	- 20 to + 60°C
Min. required current at 220 V and 240 V respectively:	95/105 µ A
Max. current:	160 µ A
Protective standard:	IP40

Control of photo current

Current through photo unit is measured with a d.c. ammeter (a moving coil instrument connected in series with the photo unit).

8. FAULT LOCATION

8.1 Burner will not start

Symptom	Causes	Remedies
Motor starts	Unstable flame	Adjust the damper
Burner pre-ventilates	Excess air	Check the oil pressure
	Low oil pressure	Check the nozzle in relation to the combustion apparatus dimensions and the ignition electrode position
Flame formed	Incorrect combustion apparatus settings	Check the flame monitor is clean and can register light
Burner trips	Flame monitor does not register light	Check with using new photocell
	Defective flame monitor	Check using new oil burner control (Note: replacement of photocell recommended if oil burner control replaced)
Motor starts	Defective oil burner control	Check the oil supply to the burner and that there are no air bubbles in the pump
Burner pre-ventilates		Check function of solenoid
No flame formed	No oil	Check flame monitor does not register ambient light
Burner trips	False light	Check high voltage wiring and ignition electrodes
	No spark	

8.2 Burner will not start after normal use

Burner does not start	Fuse blown	Check and replace fuse as necessary. Investigate cause of fault
	Boiler thermostat has not reset	Adjust thermostat
Burner pre-ventilates	Overheating protection has deployed	Reset the overheating protection. Investigate the cause of its deploying. Remedy fault
	Defective preheater	Check by replacing with new
	Defective oil burner control or flame monitor	Check that tank, oil lines, solenoid valves, pump and nozzle are in good condition
	No oil supply	Adjust the burner
Burner stops	Too great a pressure drop at brake plate	Correct the boiler draught
	Too strong draught prevents flame forming	Check the ignition transformer. Check the ignition electrode settings and ceramics
	No spark	

8.3 Delayed ignition, burner starts; pulsation

Burner pulsates at start with hot flue gases	Too strong a draught	Correct the boiler draught
	Too great a pressure drop at brake plate	Adjust the burner
	Nozzle partially blocked	Replace nozzle
Burner pulsates at start	Oil pressure too low	Check and adjust
	Flue blocked or damaged	Check and correct
	Fan wheel slipping on shaft	Check and tighten
	Pump coupling loose or worn	Replace
	Preheater clogged	Check ignition electrode adjustment (refer to technical data)
	Delayed ignition	Check ignition electrodes not damaged
	Too strong a draught	Check high voltage wiring
	Too great a pressure drop at brake plate	Check position of nozzle assembly adjustment
		Correct the boiler draught
		Adjust the burner

Försäkran om överensstämmelse
Declaration of conformity
Konformitätserklärung
Déclaration de conformité



Brännare, Burner, Ölbrenner, Brûleur

Certifikat TÜV Süddeutschland

Certifikat nr.	Typ, Type:	Certifikat nr.	Typ, Type:
08128915006	BF 1	02119815003	B 20, B 30, B 40, B 45
01111110535004	B 1	02119815004	B 50, B 60, B 70, B 80
0207110535005	B 2	040588622001	B 55
02119815001	ST 97, ST 108, ST 120, ST 133, ST 146	040588622002	B 65
02119815002	B 9, B 10, B 11	13129815007	B 45 MF, B 45-2 MF

Enertech AB försäkrar under eget ansvar att ovannämnda produkter är i överensstämmelse med följande standarder eller andra regelgivande dokument och uppfyller tillämpliga delar i EU direktiv.

Enertech AB declares under sole responsibility that the above mentioned product is in conformity with the following standards or other normative documents and follows the provisions of applicable parts in the following EU Directives.

Enertech AB erklärt in eigener Verantwortung, dass obenstehende Produkte mit folgenden Normen oder anderen normativen Dokumenten und anwendbare Teile in EU-Direktiven in Übereinstimmung stehen

Enertech AB déclare sous sa seule responsabilité que les produits désignés ci-dessus sont conformes aux normes et aux documents normatifs suivants et satisfont aux critères applicables des directives CE suivantes:

Dokument: EN 267
EN 60335

EU direktiv. EU Directives, EU-Direktiven, CE suivantes:

2004/108/EC	Elektromagnetisk kompatibilitet, Electromagnetic compatibility EC-Richtlinie, Compatibilité électromagnétique
2006/95/EC	Lågspänningsdirektivet, Low-voltage directive, Niederspannungs-Richtlinie, Directive sur les basses tensions
2006/42/EC	Maskindirektivet, Machinery directive, Maschinen-Richtlinie, Directive sur les machines
92/42/EEC	Verkningsgradsdirektivet, Efficiency directive, Wirkungsgrad-Richtlinie, Directive sur les exigences de rendement

Genom att brännaren uppfyller ovannämnda standarder och direktiv erhåller brännaren CE - märkningen.

In that the burner conforms to the above mentioned standards it is awarded the CE mark.

Indem der Brenner die obengenannten Normen und Richtlinien erfüllt, erhält der Brenner die CE-Kennzeichnung.

Du fait de leur conformité aux directives mentionnées ci-dessus, les brûleurs Bentone bénéficient du marquage CE.

Enertech AB, Bentone Division/
är kvalitetscertifierat enligt/
is quality certified according to/
ist nach dem Qualitätsmanagement /
est certifiée à la norme de qualité
SS-EN ISO 9001:2008

Ljungby, Sweden, 150227 (27/02/15)

ENERTECH AB Bentone Division

Box 309
SE-341 26 Ljungby Sweden

Håkan Lennartsson

OIL BURNERS MAINTENANCE INSTRUCTIONS

General information

Keep the boiler room clean. Ensure that the boiler room has permanent fresh air intake. Switch off before dismantling the oil burner.

At hinged mounting, make sure that an automatic safety switch is fitted, so that the burner cannot start when the swing door is open.

Don't use the oil fired boiler to burn paper or rubbish, unless the boiler is especially fitted with a hinged door to make this possible.

Don't fill tank while burner is working.

Starting precautions

Make sure that the oil tank is not empty

Make sure that the valves on oil and water supply pipes are open.

Make sure that the boiler flue damper is open.

Make sure that the boiler thermostat is set at the correct temperature.

Switch on the current. Most relay systems have a delayed action so that the burner will not start for perhaps 20 seconds.

With heavy oil the delay will be longer as the burner will not start until the oil in the preheater reaches the required temperature.

If the burner will not start

Press the reset button on the relay. Check that the thermostats are correctly adjusted.

Don't forget the room thermostat, check that any fuses are intact and main switch is on.

If the burner starts but does not ignite

Make an attempt to start the burner.

Never make close repeated start attempts.

Don't restart the burner until the boiler is free from oil gases.

If the burner still does not ignite send for the service engineer.

When switching off during summer

Always use the main switch to cut out the burner even when adjusting the burner or cutting off the heating for a short time. For longer periods of shut down, close all valves and the oil supply stop-cock.

Clean the filter and nozzle by washing in petrol or paraffin.

Make sure the filter medium is not damaged or defective. Protect electrical gear from damp.

Warning

Never stand too near or put your face to the inspection or fire door, when the burner is about to start.

Never use a naked flame to ignite oil if the electrical ignition fails.

Always wait for about 10 minutes for the unburnt gases to disperse before restarting the oil burner if it has failed to ignite previously.

Installed by:

.....

Tel:

